

ASI 87188
PPAI 254687
SAGE 67383
UPIC SHOWDOWN
PPPC 20101202

Showdown[®]

DISPLAYS

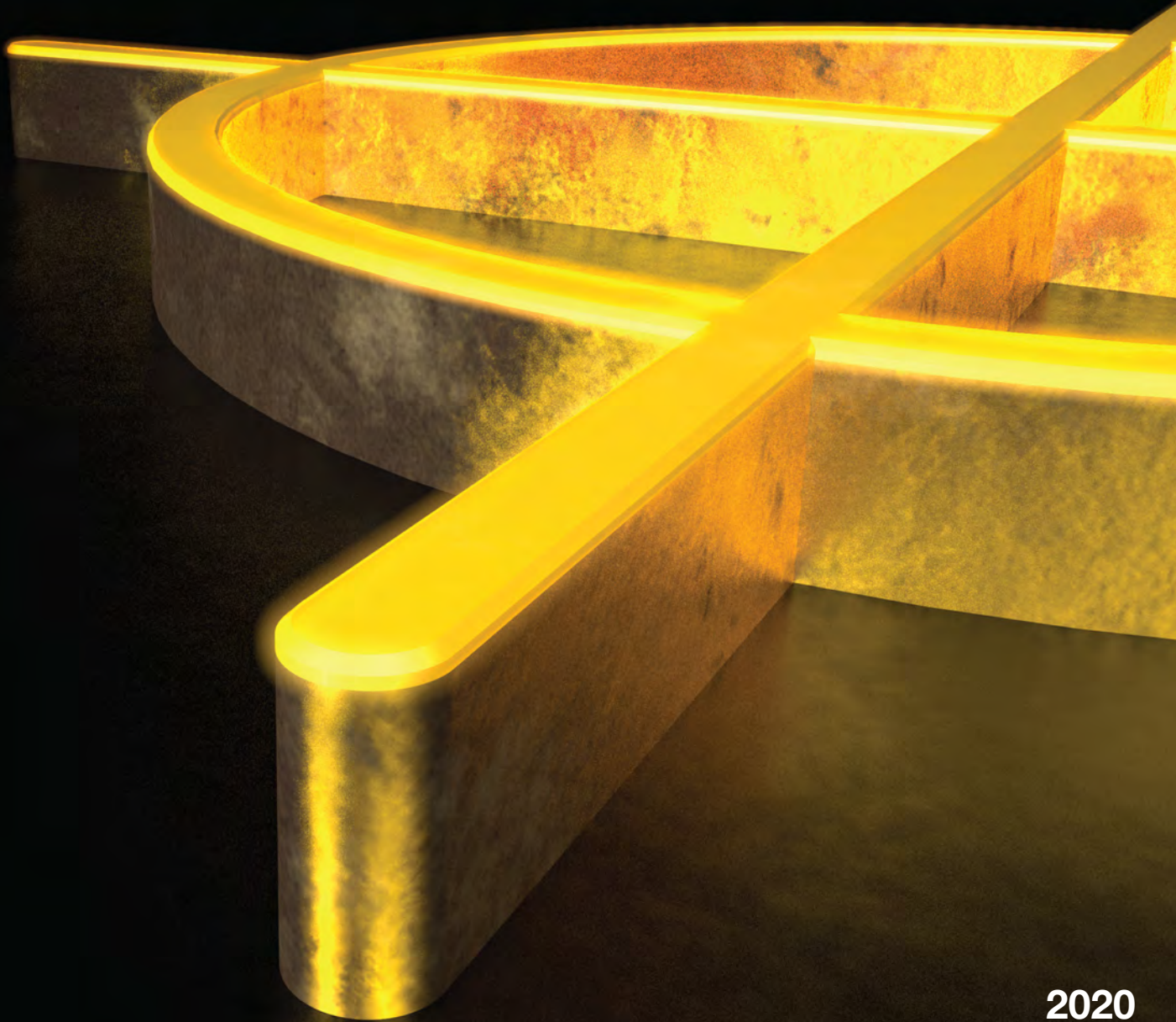

2020

USER-FRIENDLY PAGE LAYOUT MAKES FINDING PRODUCT INFORMATION QUICK AND EASY

ICONS

These icons identify features and services associated with each product, see page 5.

Suggested Uses:
Airports
Sales Campaigns
Lobbies
Trade Shows

SUGGESTED PRODUCT USES
Inspiration for how these products can be used.

RETRACTABLE BANNERS

PRODUCT SPECIFICATIONS
Dimensions, weights, sizes and material.

VALUE RETRACTOR

The Value Retractor is a cost-conscious option for your portable signage needs.

- Banner available in Titan™ polypropylene media or Titan™ no-curl hybrid media
- Two swivel feet for stability
- Available in three widths



Value Retractor

Item #	Description	1	2-5	6-11	12-24
262240	31.5" Polypropylene Media Kit	167.00	157.00	149.00	139.00
262241	31.5" No-Curl Hybrid Media Kit	215.00	202.00	191.00	178.00
262243	33.5" Polypropylene Media Kit	183.00	172.00	163.00	150.00
262244	33.5" No-Curl Hybrid Media Kit	240.00	226.00	214.00	200.00
262246	36" Polypropylene Media Kit	209.00	196.00	186.00	173.00
262247	36" No-Curl Hybrid Media Kit	271.00	255.00	241.00	225.00

Kit Includes: Hardware, Installed Banner and Soft Carry Case

Description	Product Size	Retractor Graphic Size	Product Wt.
31.5"	31.5" W x 82.7" H x 10" D	31.5" W x 75.5" H	7 lbs.
33.5"	33.5" W x 82.7" H x 10" D	33.5" W x 75.5" H	7.25 lbs.
36"	36" W x 82.7" H x 10" D	36" W x 75.5" H	7.6 lbs.



Shock cord pole makes setup and teardown easy.



Lightweight aluminum base with plastic ends.



PRODUCT DETAILS
Additional product information alongside detailed images.

Setup fee: \$20.00(G); no setup fee on orders placed via our website; see page 224 for details. View current graphic templates, assembly videos and instructions on our website. See pages 224-226 for additional information that may apply to your order.

2DAYS

SHOWDOWNDISPLAYS.COM • ASI 87188 • PPAI 254687 • SAGE 67383 • PPPC 20101202

PRODUCTION LEAD TIME

The number of days an imprinted product will take to produce after receiving final proof approval (see page 194 for details).

WANT TO LEARN MORE?

VISIT OUR WEBSITE FOR DETAILED PRODUCT INFORMATION OR TO PLACE AN ORDER

ARTWORK TEMPLATES

Download PDF templates and set up your artwork using industry-preferred design software.

PRODUCT IMAGES

Detailed and high-resolution images of product features.

PRODUCT INSTRUCTIONS

Detailed PDF instructions are available to view, print or download.

ASSEMBLY VIDEOS

Step-by-step assembly instruction videos ensure quick and easy setup.

2% OFF ONLINE ORDERS!

NO SETUP FEES ON ONLINE ORDERS!



GET YOUR ORDER FASTER

Sometimes regular lead times aren't fast enough. We understand. Here are a couple options to help you get what you need when you need it.

RUSH

Option 1

Reduce lead times by one or two days for an additional fee (Quick Ship products excluded).

Monday	Tuesday	Wednesday	Thursday
01	02	03	04
Final Proof Approval Received (after 12:00 p.m. Central)	SHIP 2 DAYS SOONER Rush Charge \$125.00(G)	SHIP 1 DAY SOONER Rush Charge \$75.00(G)	3 BUSINESS DAYS PRODUCTION LEAD TIME No Rush Charge

STANDARD RUSH CHARGES

Example Production Calendar Based on a Standard 3 Day Production Lead Time

Rush service requires approval by customer care. See page 226 for details. Same day service not available.

Option 2

Select products ship in just 24 or 48 hours.



Tents
See pages 104, 105, 106

Sail Signs
See page 94

Splash Displays
See page 189

Table Covers
See pages 9, 11, 12

Order must be placed via our website. See page 226 for complete Quick Ship program requirements and ordering information.

PRODUCT INDEX

TABLE COVERS (6-25)



Accent Table Runner	25
★ Convertible Table Throw <small>QUICK SHIP</small>	12
★ Economy Table Throw <small>QUICK SHIP</small>	8-9
Enviro Table Throw	20
Fitted Round Table Throw	18
Fitted Table Throw	16
Lateral Table Runner	25
LazerLine NEW!	22
● Outdoor Fitted Table Throw	17
Premium Table Throw	13
Round Table Throw	18
Satin Table Throw	19
Stain-Resistant Table Throw NEW!	21
★ Standard Table Runner	24
★ Standard Table Throw <small>QUICK SHIP</small>	10-11
TABLE COVER COMPARISON CHART	7
UltraFit Crossover	15
★ UltraFit Table Throw	14-15
UltraFit Table Topper	15
Value Lite Table Throw	23

RETRACTABLE BANNERS (26-45)



Change Agent Retractor	35
★ Deluxe Pro Retractor	34
★ Economy Plus Retractor	32
★ Economy Retractor	30-31
● Element Retractor NEW!	42
Ideal Retractor	28
Jumbo Wide Retractor	44
Lumos Retractor	39
MagnaChange Retractor	38
MagnaLink Retractor	40
Mini Retractors	45
Optimum Retractor	36
● Outdoor A-Frame Retractor NEW!	43
● Outdoor Retractor	41
● Outdoor Trek Lite Retractor	41
RETRACTABLE BANNER COMPARISON CHART	27
★ Stratus Retractor	33
★ Superb Retractor	37
Value Retractor	29
XChange Retractor	37

BANNER DISPLAYS (46-63)



Base-X Banner Display	56
Curved Cantilever Banner Display	54
Euro-X Banner Display	51
★ EuroFit Banner Display	58
EuroFit Hanging Banner	59
EuroFit Pro Hanging Banner	59
★ Everyday Banner Display	52
Everyday Impress Display NEW!	53
Flex Banner Display	56
FrameWorx Banner Display	47-49
FrameWorx Face Cutout Banner Display	50
● Headliner Face Cutout Banner Display NEW!	62
● Headliner Banner Display	61
Monopode Display NEW!	54
● Outdoor Ballast Display NEW!	63
● Outdoor Dual Trak Banner Display	62
● Performer Banner Display	60
● Performer Face Cutout Banner Display NEW!	62
● Power Grip	51
Sidekick Banner Display	57
Sidekick Plus Banner Display	57
Side Snap Banner Display NEW!	55
Taurus Banner Display	51
Tri-X Banner Display	51
★ Trilogy Banner Display	55

BANNERS & FLAGS (64-101)



BANNER MATERIAL COMPARISON CHART	65
● Banners - 9 oz. Mesh Vinyl	66
● Banners - 10 oz. Scrim Vinyl	66
★ Banners - 13 oz. Scrim Vinyl	66
● Banners - 13 oz. Smooth Scrim Vinyl	67
● Banners - 18 oz. Opaque Scrim Vinyl	67
● Banners - Fence NEW!	68
Banners - Polyester Poplin	69
Banners - Satin	69
● Banners - Super Poly Knit Fabric	69
● Banners - Tearaway NEW!	72
● Boulevard Banners - Brackets	71
● Boulevard Banners - Fabric	70
● Boulevard Banners - Nylon NEW!	70
● Boulevard Banners - Vinyl	70
● Boulevard Banners - Wall-Mount Bracket System	71
FLAG COMPARISON CHART	73
● Flags - Body NEW!	83
● Flags - Bunting NEW!	85
● Flags - Car NEW!	82
● Flags - City NEW!	79
★ Flags - Fabric	81
● Flags - Fan NEW!	85
● Flags - Garden NEW!	84
● Flags - Golf NEW!	82
● Flags - Historical NEW!	78
● Flags - International NEW!	78
● Flags - Message NEW!	81
● Flags - Military NEW!	77

BANNERS & FLAGS CONTINUED (64-101)

● Flags - Nylon Burgee NEW!	75
● Flags - Nylon Guidon NEW!	75
● Flags - Nylon Pennant NEW!	75
● Flags - Nylon Rectangle NEW!	74
● Flags - Pennant Strings NEW!	85
● Flags - Religious NEW!	80
● Flags - Solid Color Nylon NEW!	80
● Flags - Spirit Flag NEW!	83
● Flags - State NEW!	79
● Flags - Stick NEW!	84
● Flags - United States NEW!	76
● Flutter Flags - Message NEW!	97
● Flutter Flags - Solid Color NEW!	97
● Flutter Flags - Stadium NEW!	96
● Giant Outdoor Flag	101
SAIL SIGN COMPARISON CHART	86-87
● Sail Sign - 24-Hour & 48-Hour Quick Ship <small>QUICK SHIP</small>	94
● Sail Sign - Accessories NEW!	99
● Sail Sign - Ballast Block	98
● Sail Sign - Mini	100
● Sail Sign - Motorized Spinner Base	98
★ ● Sail Sign - Premium NEW!	92-93
● Sail Sign - Solid Color Streamline Blade NEW!	95
● Sail Sign - Solid Color Value Blade NEW!	95
● Sail Sign - Streamline NEW!	90-91
● Sail Sign - Tri-Post Base	98
● Sail Sign - Value NEW!	88-89

TENTS (102-117)



● 10' Tent with Vented Canopy	109
● Accessories	117
● Awning	116
● Compact 10'	108
● Deluxe 6' & 8'	110
● Deluxe 10' <small>QUICK SHIP</small>	105
● Elite 10' NEW!	107
● Modular Event Counter	117
★ ● Premium 10' <small>QUICK SHIP</small>	106
● Premium 15' & 20'	111
● Premium Gable 10', 15' & 20' NEW!	112-113
★ ● Standard 10' <small>QUICK SHIP</small>	104
TENT COMPARISON CHART	103
● Valance Wrap	116
● Walls	114-115

PARADES & EVENTS (118-127)



● Backpack Banners	124
● Bag Toss Game and Value Bag Toss Game	126
● Floral Sheeting NEW!	120-121
● Fringe NEW!	123
● Outdoor Event Cooler	125
● Parade Float Kits NEW!	119
● Prize Drop	127
● Prize Putt	127
● Selfie Frame	124
● Spin 'N Win Prize Wheel	125
● Spin 'N Win Prize Wheel Plus	125
● Twist NEW!	122



SIGNAGE (128-151)

● Barricade Cover	140
● Base-X Sign	142
● Canvas Signboard NEW!	146
● Corrugated Plastic Sign	139
● Countertop Mat	148
● Crystal Edge Display	145
● Deluxe Wood A-Frame	132
● Door Wrap	148
● Economy Wood A-Frame	132
● EuroFit A-Frame	136
● EuroFit Ballast Base	141
● EuroFit Barrier	140
● Floor Decor	151
★ Floor Hugger Mat	150
● FrameWorx Flex	141
● Front-Load Frame	144
● Glossy Aluminum Signboard NEW!	147
● Horizontal A-Frame	135
● Impress Sign NEW!	143
● Indoor Surface Grip	149
● LED Light Box	145
● Marketing Mat NEW!	151
★ ● Outdoor Flex Signs	138
● Outdoor Rigid Base Sign	139
● Outdoor Surface Tac	149
● Parking Pal NEW!	137
● Quick Change Wood A-Frame	133
● Sign Displays	142
SIGNAGE COMPARISON CHART	129
● Signicade A-Frame	131
★ ● Signicade A-Frame - Deluxe	130
● Signicade A-Frame - Metropolitan	131
● Signicade A-Frame - Minicade	130
● Signicade A-Frame - Narrowcade	131
★ ● Simpo Sign II A-Frame	130
● Simpo Square A-Frame	130
★ ● Storm Mat	150
● Sunrise Lawn Sign NEW!	137
● Superstrong Angle Iron A-Frame	135
● Top-Load Frame	144
● Twist-Up Oval A-Frame	136
● Uptown A-Frame	134
● Uptown Accent A-Frame	134



TABLETOP DISPLAYS (152-165)

ARISE Tabletop Display	158
Dynamo Trifecta Display	159
EuroFit Monarch	163
EuroFit Tabletop Straight Wall	153
★ Fast Trak Display	160
★ Micro GeoMetrix Display	154-155
Mini Retractors & Banner Displays NEW!	164-165
Over-The-Top Display	162
Show 'N Write Display	161
Splash Tabletop Display	156
Verge Tabletop Display	157
Verge Glo Tabletop Display	157



FLOOR DISPLAYS (166-203)

ARISE Pop-Up Display	202-203
Bravo Expanding Display	185
Case-to-Counter Conversion Kit	201, 203
Deluxe Exhibitor Expanding Display	184
Deluxe GeoMetrix Back Wall	198
Deluxe GeoMetrix Connector Display	196-197
★ Deluxe GeoMetrix Display	194-195
Deluxe GeoMetrix Edge Panels	198
Echo Pop-Up Display	199
EuroFit - Wall Accessories	170
EuroFit - Arc Wall	168
EuroFit - Arch	174
EuroFit - Arch Plus	174
EuroFit - Chalet	175
EuroFit - Evolution Displays NEW!	176-177
EuroFit - Gateway	175
EuroFit - Incline Wall	168
EuroFit - Infinity	173
EuroFit - Light Clamp	172
EuroFit - Motorized Spinner Base	172
EuroFit - Overlap	171
★ EuroFit - Straight Wall NEW!	169
EuroFit - Tagalong	171
EuroFit - Triumph with Runner	175
EuroFit - Vortex	173
EuroFit - Wheeled Feet	172
Fusion Glo NEW!	180
GeoMetrix and Deluxe GeoMetrix Graphic Panels	198
GeoMetrix Display	192-193
LitFit Wall	182
Pipe & Drape Banner and Header	183
POP-UP COMPARISON CHART	186
Radius Glo	181
★ Show 'N Rise Pop-Up Display	200-201
★ Splash Display NEW! <small>QUICK SHIP</small>	188-189
Traverse Display	183
Verge Display	190
Verge Glo Display	191
Xarisma™ SEG Frame System NEW!	178-179



STANDS & FURNITURE (204-215)

Boost Ball Chair	213
CounterPop	206
● Director's Chair	213
Easels	211
Impress Counters	209
Literature Displays NEW!	212
Opulent Digital Incline NEW!	214-215
Opulent Digital Tower NEW!	214-215
Power Pedestal	205
Quad Pod Monitor Stand	211
Sail Tablet Stand	210
ShowGoer Case-to-Podium	207
ShowGlower Podium	209
Tablet Stand	210

ACCESSORIES (216-217)

Hard Cases	216
Soft Cases	217
★ Ultimate LED Light Kits	217















TOTAL SHOW PACKAGES (218-223)

Change-Up	220
Product Promoter	221
● Market Fest	223
● Tabletop GeoMetrix Pop-Up	220
● Photo Fun Indoor	222
● Photo Fun Outdoor	222
★ Tabletop Classic	219
★ Tailgater	223
● Transformer NEW!	221
● Trunk-to-Anywhere	219

USER-FRIENDLY ICONS

These icons identify features and services associated with each product.

-  **BEST SELLER**
This is one of our best-selling products.
-  **1 YEAR PRODUCT WARRANTY**
This is the duration of this product warranty (see page 194 for details).
-  **VIDEO SETUP**
Setup instructions for this product can be found on our website.
-  **OUTDOOR USE**
This product is suitable for outdoor use during mild weather conditions.
-  **MADE IN THE USA**
This product is manufactured in the USA.
-  **QUICK SHIP**
We can ship this product within 24 or 48 hours (see page 194 for details).
-  **MACHINE-WASHABLE**
This product is machine-washable on gentle cycle using mild detergent.
-  **200 RCAT RATING**
A rating that relates to the durability of a retractable banner (see page 27 for details).
-  **GRAPHICS ONLINE**
Graphic only options available on our website.
-  **HARDWARE ONLINE**
Hardware only options available on our website.
-  **CASE**
This product includes a hard case or soft carry case.
-  **LIGHTS UP**
This product lights up.
-  **TOOL(S) REQUIRED**
This product requires tool(s) for setup; tool(s) included.



1. UltraFit page 14 | 2. Standard page 10 | 3. Standard Runner page 24

TABLE COVERS

When choosing a table cover
have you considered...

- **SIZE** - What size is your table?
- **FABRIC/MEDIA** - What type of material are you looking for?
- **FREQUENCY** - How often will you be using your table cover?
- **USE** - Will people be sitting at the table, or will it be used to showcase merchandise or promotional materials?
- **MESSAGE** - Do you want a logo printed on the front, or would you like a design that covers the entire throw?

TABLE COVER COMPARISON CHART

★ = Best Sellers		PG	SIZES	FIT	TABLE COVERAGE	TABLE COVER MATERIAL	EDGE FINISHING	FLAME RETARDANT	WASHABLE	QUICK SHIP OPTIONS	PRINT OPTIONS
RECTANGULAR	Value Lite	23	6' & 8'	Drape	4-Sided	Polyester Pongee	Serged		Disposable		1-Color White Imprint Only
	NEW! LazerLine	22	4', 6' & 8'	Drape	3-Sided & 4-Sided	Polyester Poplin	Laser Cut	✓	Machine		Full-Color Front Only
	Economy ★	8	4', 6' & 8'	Drape	3-Sided	Polyester Poplin	Serged	✓	Machine		Full-Color Front Only Full-Color Full-Bleed
	Standard ★	10	4', 6' & 8'	Drape	4-Sided	Polyester Poplin	Serged	✓	Machine		Full-Color Front Only Full-Color Full-Bleed
	Enviro	20	6' & 8'	Drape	3-Sided & 4-Sided	Polyester Poplin	Serged	✓	Machine		Full-Color Imprint
	Stain-Resistant	21	6' & 8'	Drape	3-Sided & 4-Sided	Polyester Poplin	Serged	✓	Machine		Full-Color Imprint
	Fitted	16	4', 6' & 8'	Fitted	4-Sided	Polyester Poplin	Serged	✓	Machine		Full-Color Front Only Full-Color Full-Bleed
	Convertible ★	12	8' Converts to 6'	Drape Converts to Fitted	4-Sided	Polyester Poplin	Serged	✓	Machine		Full-Color Front Only Full-Color Full-Bleed
	Satin	19	6' & 8'	Drape	3-Sided & 4-Sided	Polyester Satin	Serged	✓	Machine		Full-Color Full-Bleed
	UltraFit Demo	15	4'	Snug Fitted	4-Sided	Two-Way Stretch Fabric	Hemmed	✓	Machine		Full-Color Full-Bleed
	Outdoor Fitted	17	6' & 8'	Fitted	4-Sided	400 Denier Polyester	Serged	✓	Machine		Full-Color Full-Bleed
	Premium	13	6' & 8'	Drape	4-Sided	Two-Way Stretch Fabric	Hemmed	✓	Machine		Full-Color Full-Bleed
	UltraFit Curve	14	4', 6' & 8'	Snug Fitted	3-Sided	Two-Way Stretch Fabric	Hemmed	✓	Machine		Full-Color Full-Bleed
UltraFit Classic ★	14	4', 6' & 8'	Snug Fitted	4-Sided	Two-Way Stretch Fabric	Hemmed	✓	Machine		Full-Color Full-Bleed	
ROUND	Fitted Round	18	31.5" Bar-Height	Fitted	4-Sided	Polyester Poplin	Serged	✓	Machine		Full-Color Front Only Full-Color Full-Bleed
	Round	18	31.5" Café-Height, 31.5" Bar-Height, 3', 4' & 5'	Drape	4-Sided	Polyester Poplin	Serged	✓	Machine		Full-Color Full-Bleed
	UltraFit Round	15	31.5" Bar-Height	Snug Fitted	4-Sided	Two-Way Stretch Fabric	Hemmed	✓	Machine		Full-Color Full-Bleed
PARTIAL COVERAGE	Lateral Runner	25	125" & 149"	Drape	Top & Partial Sides	Polyester Poplin	Serged	✓	Machine		Full-Color Top Only Full-Color Full-Bleed
	NEW! LazerLine Runner	22	28" & 57"	Drape	Partial Front, Top & Back	Polyester Poplin	Laser Cut	✓	Machine		Full-Color Front Only
	Standard Runner ★	24	28" & 57"	Drape	Partial Front, Top & Back	Polyester Poplin	Serged	✓	Machine		Full-Color Front Only Full-Color Full-Bleed
	Accent Runner	25	28" & 57"	Drape	Partial Front, Top & Back	Polyester Satin	Satin Trim	✓	Machine		Full-Color Imprint Full-Color Full-Bleed
	UltraFit Table Topper	15	6' & 8'	Snug Fitted	Top Only	Two-Way Stretch Fabric	Hemmed	✓	Machine		Full-Color Full-Bleed
	UltraFit Crossover	15	6'	Snug Fitted	Partial 4-Sided	Two-Way Stretch Fabric	Hemmed	✓	Machine		Full-Color Full-Bleed

NOTE: Flame-retardant table covers are FR Rated (flame retardant treated) in compliance with the National Fire Protection Association Standard No. 701

TOP SELLER
POLYESTER POPLIN

Lightweight and durable; our most popular fabric choice.

TABLE COVER MATERIAL

TWO-WAY STRETCH FABRIC

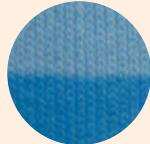

Nearly opaque with a luxurious look and a high-class hemmed finish.

POLYESTER SATIN



Rich, lustrous fabric with an upscale look.

400 DENIER POLYESTER

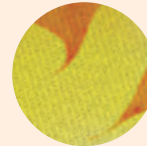

The same durable, weather-resistant material we use for our tent canopies.

POLYESTER PONGEE



Lightweight and designed for limited use.

PRINT OPTIONS



Underside of material is stock fabric color.



Underside of material is blank.



Underside of material is blank.

Full-Color Imprint

- Graphics can range in complexity from a simple one-color design to a detailed full-color design (item specific, see product pages for details)
- Vector art required
- Available in limited stock fabric colors only
- Artwork is imprinted on front only
- Minimum and maximum artwork size requirements apply
- Always roll your table throw for storage; do not fold
- Available on select throws only

Full-Color Front Only

- Graphic can range in complexity from a simple one-color design to a detailed full-color design
- Vector art preferred
- Available in stock fabric colors only
- Artwork is printed on front only
- Maximum artwork size requirements apply
- Now offering a larger maximum imprint area for more graphic coverage
- Fold and store in included poly bag

Full-Color Full-Bleed

- Ideal for complex designs, photographic images, or art with gradients
- Vector and raster art accepted
- Art is dye sublimated on white fabric only
- Full-color artwork can be printed across the entire throw
- No artwork size restrictions
- Fold and store in included poly bag

ECONOMY TABLE THROW

The open-back design of this throw gives you legroom and quick access to anything you store beneath the table.

- Now offering a larger maximum print area for even more ad space on Full-Color Front Only throws
- Draped corners
- Polyester poplin
- Machine-washable and wrinkle-resistant
- Flame retardant treated (FR rated for exhibit halls)



Suggested Uses:
Event Check-Ins
Fundraisers
Career Fairs
Trade Shows



TABLE CLAMPS

Securely fasten your table cover to the table with these convenient clamps.

- Set of four
- Constructed of stainless steel



Table Clamps

Item #	Description	1	2-5	6-11	12-24
240779	Table Clamps (Set of 4)	4.10	4.00	3.90	3.70

USD MSRP (C)



LARGER GRAPHIC AREA



Full-color front only



Full-color full-bleed

Full-Color Front Only

Item #	Description	1	2-5	6-11	12-24
106045	4' Economy Throw	130.00	116.00	109.00	101.00
106002	6' Economy Throw	182.00	162.00	152.00	131.00
106014	8' Economy Throw	202.00	182.00	162.00	152.00

Stock fabric colors with full-color artwork printed on front. Artwork cannot exceed maximum size requirements. USD MSRP (C)

Description	Table Size	Front Only Graphic Size	Product Wt.
4'	48"W x 29"H x 29.75"D	40"W x 25"H	1.25 lbs.
6'	72"W x 29"H x 29.75"D	64"W x 25"H	2 lbs.
8'	96"W x 29"H x 29.75"D	64"W x 25"H	2.5 lbs.

Full-Color Full-Bleed

Item #	Description	1	2-5	6-11	12-24
106042	4' Economy Throw	200.00	190.00	180.00	170.00
106010	6' Economy Throw	265.00	240.00	225.00	210.00
106022	8' Economy Throw	290.00	260.00	245.00	225.00

White fabric fully dye sublimated with full-color artwork. USD MSRP (C)

Description	Table Size	Full-Bleed Graphic Size	Product Wt.
4'	48"W x 29"H x 29.75"D	View Online Template	1.25 lbs.
6'	72"W x 29"H x 29.75"D	View Online Template	2 lbs.
8'	96"W x 29"H x 29.75"D	View Online Template	2.5 lbs.



Quick Ship Economy Throw

Item #	Description	1	2-5	6-11
106030	24-Hour Quick Ship 6' Full-Color Front Only	375.00	280.00	205.00
106031	24-Hour Quick Ship 8' Full-Color Front Only	395.00	300.00	215.00
106040	48-Hour Quick Ship 6' Full-Color Full-Bleed	490.00	395.00	NA
106041	48-Hour Quick Ship 8' Full-Color Full-Bleed	520.00	415.00	NA

Order must be placed via our website. USD MSRP (C)
See page 226 for complete Quick Ship program requirements and ordering information.

Stock Table Throw Colors

PMS colors are for reference only and may vary slightly from actual color.

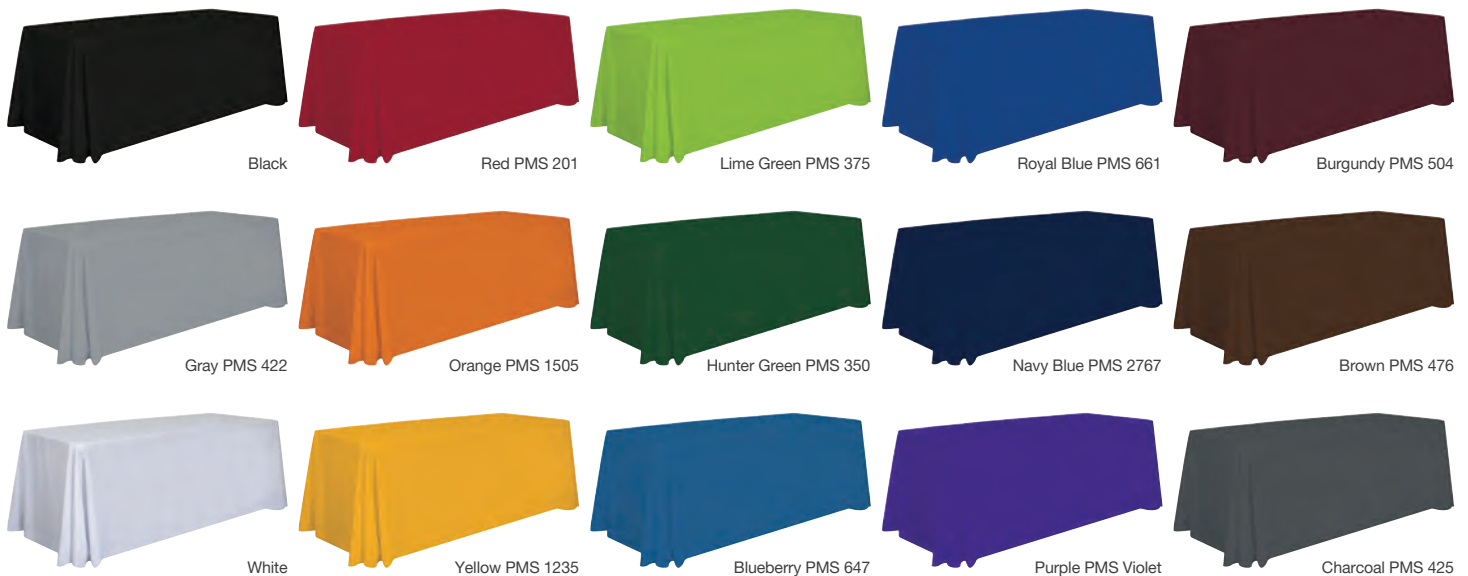

Setup fee: \$20.00(G); no setup fee on orders placed via our website; see page 224 for details. View current graphic templates, assembly videos and instructions on our website. See pages 224-226 for additional information that may apply to your order.

AFTER FINAL PROOF APPROVAL
PRODUCTION LEAD TIME IS
2 DAYS

STANDARD TABLE THROW

Our most popular table throw is elegant in its simplicity.

- Now offering a larger maximum print area for even more ad space on Full-Color Front Only throws
- Covers four sides of the table, viewable from all sides
- Draped corners
- Polyester poplin
- Machine-washable and wrinkle-resistant
- Flame retardant treated (FR rated for exhibit halls)



Suggested Uses:
 Information Tables
 Lobbies
 Trade Shows
 Meetings



Front view

6' with full-color full-bleed

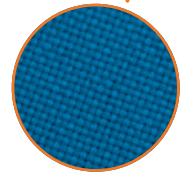

Wrinkle-resistant, durable polyester poplin.



Back view

Keep your supplies and accessories out of sight.

LARGER GRAPHIC AREA



Full-color front only



Full-color full-bleed

TABLE COVERS

Full-Color Front Only

Item #	Description	1	2-5	6-11	12-24
109105	4' Standard Throw	140.00	125.00	118.00	109.00
109002	6' Standard Throw	202.00	172.00	162.00	152.00
109014	8' Standard Throw	222.00	192.00	182.00	161.00

Stock fabric colors with full-color artwork printed on front. Artwork cannot exceed maximum size requirements. USD MSRP (C)

Description	Table Size	Front Only Graphic Size	Product Wt.
4'	48"W x 29"H x 29.75"D	40"W x 25"H	1.5 lbs.
6'	72"W x 29"H x 29.75"D	64"W x 25"H	2.5 lbs.
8'	96"W x 29"H x 29.75"D	64"W x 25"H	3 lbs.

Full-Color Full-Bleed

Item #	Description	1	2-5	6-11	12-24
109106	4' Standard Throw	260.00	247.00	234.00	221.00
109010	6' Standard Throw	295.00	265.00	250.00	235.00
109022	8' Standard Throw	315.00	285.00	270.00	250.00

White fabric fully dye sublimated with full-color artwork. USD MSRP (C)

Description	Table Size	Full-Bleed Graphic Size	Product Wt.
4'	48"W x 29"H x 29.75"D	View Online Template	1.5 lbs.
6'	72"W x 29"H x 29.75"D	View Online Template	2.5 lbs.
8'	96"W x 29"H x 29.75"D	View Online Template	3 lbs.



Quick Ship Standard Throw

Item #	Description	1	2-5	6-11
109031	24-Hour Quick Ship 6' Full-Color Front Only	395.00	290.00	215.00
109032	24-Hour Quick Ship 8' Full-Color Front Only	410.00	305.00	230.00
109048	48-Hour Quick Ship 6' Full-Color Full-Bleed	520.00	415.00	NA
109049	48-Hour Quick Ship 8' Full-Color Full-Bleed	540.00	435.00	NA

Order must be placed via our website. USD MSRP (C)
See page 226 for complete Quick Ship program requirements and ordering information.

Stock Table Throw Colors

PMS colors are for reference only and may vary slightly from actual color.

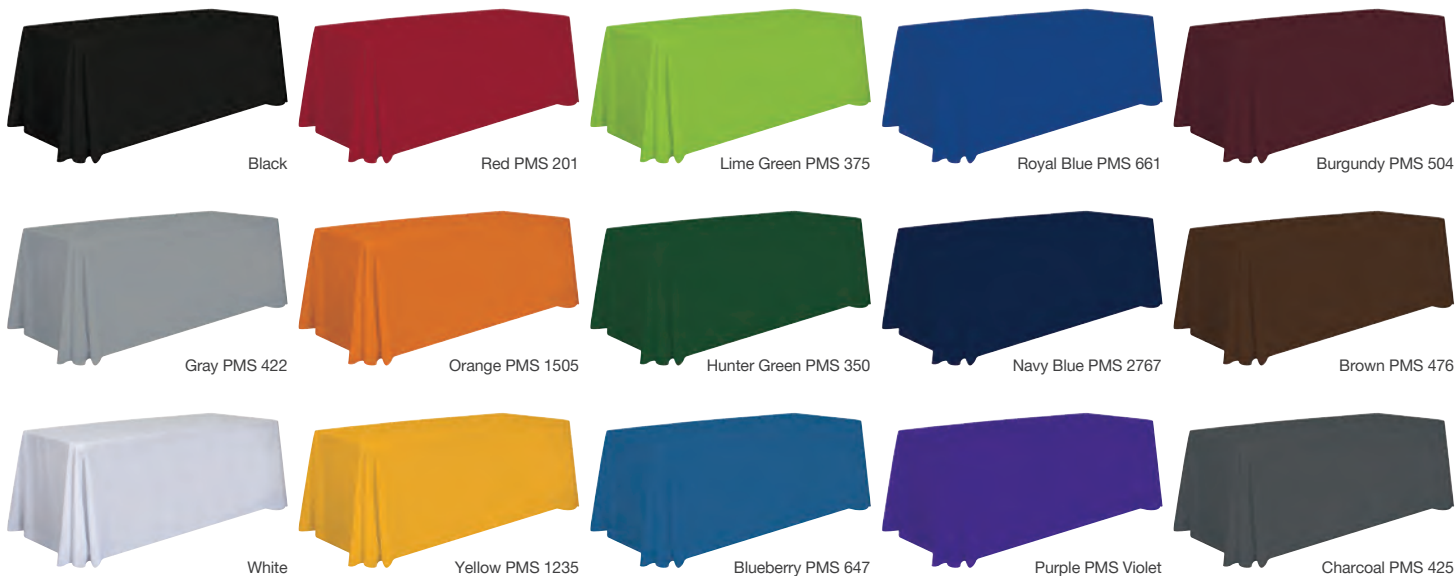

Setup fee: \$20.00(G); no setup fee on orders placed via our website; see page 224 for details. View current graphic templates, assembly videos and instructions on our website. See pages 224-226 for additional information that may apply to your order.

AFTER FINAL PROOF APPROVAL
PRODUCTION LEAD TIME IS
2 DAYS



8' with full-color full-bleed transforms into a 6' fitted



Converts from 8' to 6' and Back Again!



1. Grab the back corner of the table throw.



2. Attach the corner to the back of the throw using the built-in hook-and-loop fasteners.



3. Grab the front corner of the throw and fold it tightly around the back corner of the table.



4. Secure it in place with the built-in hook-and-loop fasteners.

CONVERTIBLE TABLE THROW

This throw is easily convertible so it fits both 8' and 6' table sizes.

- Now offering a larger maximum print area for even more ad space on Full-Color Front Only throws
- Hook-and-loop fasteners make size conversion quick and easy
- Covers four sides of the table
- Polyester poplin
- Machine-washable and wrinkle-resistant
- Flame retardant treated (FR rated for exhibit halls)



Stock Table Throw Colors

- Black
- Blueberry PMS 647
- Brown PMS 476
- Burgundy PMS 504
- Charcoal PMS 425
- Gray PMS 422
- Hunter Green PMS 350
- Lime Green PMS 375
- Navy Blue PMS 2767
- Orange PMS 1505
- Purple PMS Violet
- Red PMS 201
- Royal Blue PMS 661
- White
- Yellow PMS 1235

PMS colors are for reference only and may vary slightly from actual color.



Full-color front only



Full-color full-bleed

Full-Color Front Only

Item #	Description	1	2-5	6-11	12-24
104014	6'/8' Convertible Throw	255.00	225.00	215.00	205.00

Stock fabric colors with full-color artwork printed on front. USD MSRP (C)
Artwork cannot exceed maximum size requirements.

Full-Color Full-Bleed

Item #	Description	1	2-5	6-11	12-24
104022	6'/8' Convertible Throw	320.00	290.00	280.00	265.00

White fabric fully dye sublimated with full-color artwork. USD MSRP (C)

Description	Table Size	Front Only Graphic Size	Full-Bleed Graphic Size	Product Wt.
6'/8'	72"96"W x 29"H x 29.75"D	64"W x 25"H	View Online Template	3 lbs.



Quick Ship Convertible Throw

Item #	Description	1	2-5	6-11
104032	24-Hour Quick Ship 6'/8' Full-Color Front Only	445.00	340.00	265.00
104044	48-Hour Quick Ship 6'/8' Full-Color Full-Bleed	550.00	445.00	NA

USD MSRP (C)

Order must be placed via our website. See page 226 for complete Quick Ship program requirements and ordering information.

2DAYS
AFTER FINAL PROOF APPROVAL
PRODUCTION LEAD TIME IS

Setup fee: \$20.00(G); no setup fee on orders placed via our website; see page 224 for details. View current graphic templates, assembly videos and instructions on our website. See pages 224-226 for additional information that may apply to your order.

Suggested Uses:
Trade Shows
Product Demos
Meetings
Sales Kits



PREMIUM TABLE THROW

Premium throws are perfect for showcasing eye-catching, full-color imagery with an upscale look.

- Covers four sides of the table
- Draped corners
- Nearly-opaque material
- Artwork is dye sublimated on two-way stretch fabric
- Machine-washable
- Flame retardant treated (FR rated for exhibit halls)



Full-Color Full-Bleed

Item #	Description	1	2-5	6-11	12-24
109070	6' Premium Throw	450.00	400.00	375.00	350.00
109071	8' Premium Throw	475.00	420.00	395.00	370.00

White fabric fully dye sublimated with full-color artwork. USD MSRP (C)

Description	Table Size	Full-Bleed Graphic Size	Product Wt.
6'	72"W x 29"H x 29.75"D	View Online Template	3.5 lbs.
8'	96"W x 29"H x 29.75"D	View Online Template	4.75 lbs.



Setup fee: \$20.00(G); no setup fee on orders placed via our website; see page 224 for details. View current graphic templates, assembly videos and instructions on our website. See pages 224-226 for additional information that may apply to your order.

AFTER FINAL PROOF APPROVAL
PRODUCTION LEAD TIME IS
2 DAYS

ULTRAFIT TABLE THROW

This form-fitting throw is an attractive option for promoting your brand. It stretches to fit tightly around tables, creating a crisp, refined appearance.

- Tight, form-fitting look
- Artwork is dye sublimated on two-way stretch fabric
- Machine-washable and wrinkle-resistant
- Flame retardant treated (FR rated for exhibit halls)



Suggested Uses:
Trade Shows
In-Store Displays
Sidewalk Sales
Presentations



Open back for easy storage access and seating.

Back view



Table leg slips into the sleeve to pull the throw taut.

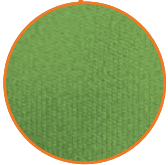

Two-way stretch fabric is nearly opaque.

8' Curve

Front view



Zippered back for enclosed storage area.

UltraFit Curve

Item #	Description	1	2-5	6-11	12-24
114032	4' Full-Color Full-Bleed	310.00	295.00	279.00	264.00
114015	6' Full-Color Full-Bleed	439.00	419.00	408.00	388.00
114018	8' Full-Color Full-Bleed	490.00	470.00	449.00	439.00

White fabric fully dye sublimated with full-color artwork. USD MSRP (C)

Description	Table Size	Full-Bleed Graphic Size	Product Wt.
4'	48"W x 29"H x 29.75"D	View Online Template	1.3 lbs.
6'	72"W x 29"H x 29.75"D	View Online Template	2.25 lbs.
8'	96"W x 29"H x 29.75"D	View Online Template	2.75 lbs.

UltraFit Classic

Item #	Description	1	2-5	6-11	12-24
114034	4' Full-Color Full-Bleed	330.00	314.00	297.00	281.00
114002	6' Full-Color Full-Bleed	460.00	440.00	430.00	410.00
114005	8' Full-Color Full-Bleed	510.00	490.00	469.00	459.00

White fabric fully dye sublimated with full-color artwork. USD MSRP (C)

Description	Table Size	Full-Bleed Graphic Size	Product Wt.
4'	48"W x 29"H x 29.75"D	View Online Template	1.75 lbs.
6'	72"W x 29"H x 29.75"D	View Online Template	2.5 lbs.
8'	96"W x 29"H x 29.75"D	View Online Template	3 lbs.



UltraFit Round

Item #	Description	1	2-5	6-11	12-24
114012	31.5" Bar-Height Full-Color Full-Bleed	355.00	345.00	325.00	305.00

White fabric fully dye sublimated with full-color artwork. USD MSRP (C)

Table Size 43"H x 31.5"D Full-Bleed Graphic Size View Online Template Product Wt. 1.75 lbs.

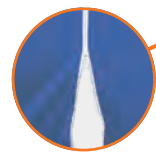

Zippered back for enclosed storage area.



UltraFit Demo

Item #	Description	1	2-5	6-11	12-24
114100	4' Full-Color Full-Bleed	390.00	375.00	360.00	345.00

White fabric fully dye sublimated with full-color artwork. USD MSRP (C)

Table Size 47.75"W x 36"H x 24"D Full-Bleed Graphic Size View Online Template Product Wt. 2 lbs.



6' Table Topper shown on an UltraFit Classic throw (sold separately)

UltraFit Table Topper

Item #	Description	1	2-5	6-11	12-24
114023	6' Full-Color Full-Bleed	240.00	215.00	200.00	185.00
114025	8' Full-Color Full-Bleed	260.00	230.00	220.00	205.00

White fabric fully dye sublimated with full-color artwork. USD MSRP (C)

Description Table Top Size Full-Bleed Graphic Size Product Wt.
 6' 72"W x 29.75"D View Online Template 1 lb.
 8' 96"W x 29.75"D View Online Template 1.25 lbs.

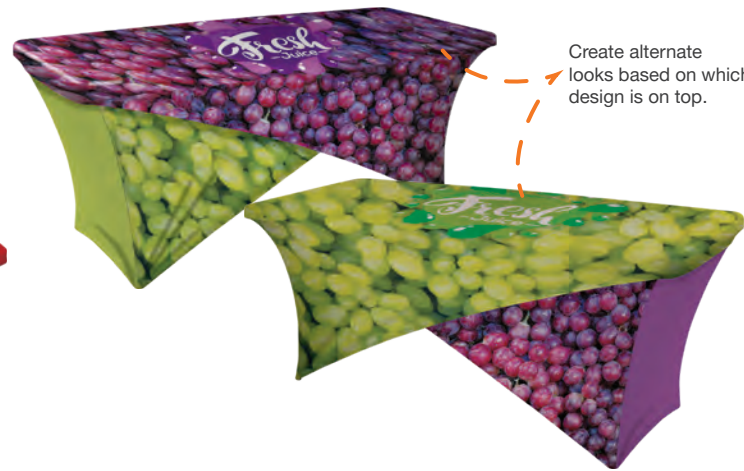

Create alternate looks based on which design is on top.

UltraFit Crossover

Item #	Description	1	2-5	6-11	12-24
109090	6' Full-Color Full-Bleed	450.00	400.00	380.00	350.00

White fabric fully dye sublimated with full-color artwork. USD MSRP (C)

Table Size 72"W x 29"H x 29.75"D Full-Bleed Graphic Size View Online Template Product Wt. 3 lbs.

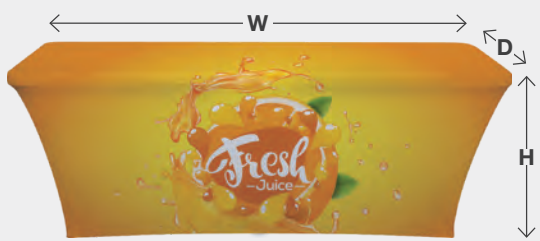

Best Fits

- 31.5" Round Table Throws**
Fits on tables: 43"H x 31.5"D
- 4' Demo Table Throws**
Fits on tables: 47.75"W x 36"H x 24"D
- 4' Classic & Curve Table Throws**
Fits on tables: 48"W x 29"H x 29.75"D
- 6' Classic & Curve Table Throws**
Fits on tables: 72"W x 29"H x 29.75"D
- 8' Classic & Curve Table Throws**
Fits on 8' tables: 96"W x 29"H x 29.75"D

Add-On



Ultimate LED Single Light Kit Item #150120 See Page 217



Recommended for UltraFit & Premium throws only. Special instructions apply; inquire for details.

Setup fee: \$20.00(G); no setup fee on orders placed via our website; see page 224 for details. View current graphic templates, assembly videos and instructions on our website. See pages 224-226 for additional information that may apply to your order.

AFTER FINAL PROOF APPROVAL PRODUCTION LEAD TIME IS **3 DAYS**

Suggested Uses:
 Career Fairs
 College Recruiting
 Registrations
 Promotional Events



6' with full-color full-bleed



4' with full-color full-bleed

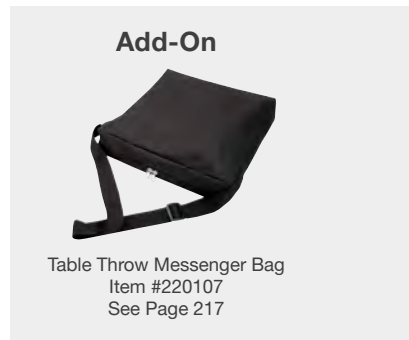

Add-On

Table Throw Messenger Bag
 Item #220107
 See Page 217

FITTED TABLE THROW

This throw is designed to fit snugly around tables. Its taut surfaces and sharp lines give it a tailored look that stands out at meetings, shows, career fairs and more.

- Tight, fitted look
- Covers four sides of the table
- Polyester poplin
- Machine-washable and wrinkle-resistant
- Flame retardant treated (FR rated for exhibit halls)



LARGER GRAPHIC AREA



Full-color front only



Full-color full-bleed

Stock Fitted Throw Colors

- Black
- Blueberry PMS 647
- Brown PMS 476
- Burgundy PMS 504
- Charcoal PMS 425
- Gray PMS 422
- Hunter Green PMS 350
- Navy Blue PMS 2767
- Purple PMS Violet
- Red PMS 201
- Royal Blue PMS 661
- White
- Yellow PMS 1235

PMS colors are for reference only and may vary slightly from actual color.

Full-Color Front Only

Item #	Description	1	2-5	6-11	12-24
115002	4' Fitted Demo Throw	181.00	161.00	151.00	141.00
107002	6' Fitted Throw	222.00	192.00	182.00	172.00
107014	8' Fitted Throw	242.00	212.00	202.00	182.00

Stock fabric colors with full-color artwork printed on front. USD MSRP (C)
 Artwork cannot exceed maximum size requirements.

Full-Color Full-Bleed

Item #	Description	1	2-5	6-11	12-24
115009	4' Fitted Demo Throw	266.00	250.00	235.00	219.00
107010	6' Fitted Throw	295.00	270.00	265.00	250.00
107022	8' Fitted Throw	315.00	290.00	275.00	260.00

White fabric fully dye sublimated with full-color artwork. USD MSRP (C)

Description	Table Size	Front Only Graphic Size	Full-Bleed Graphic Size	Product Wt.
4'	48"W x 36"H x 24"D	42"W x 17"H	View Online Template	1.5 lbs.
6'	72"W x 29"H x 29.75"D	64"W x 25"H	View Online Template	2 lbs.
8'	96"W x 29"H x 29.75"D	64"W x 25"H	View Online Template	2.5 lbs.

3 DAYS
 AFTER FINAL PROOF APPROVAL
 PRODUCTION LEAD TIME IS

Setup fee: \$20.00(G); no setup fee on orders placed via our website; see page 224 for details.
 View current graphic templates, assembly videos and instructions on our website.
 See pages 224-226 for additional information that may apply to your order.

Suggested Uses:
 Tailgating
 Corporate Events
 Outdoor Concerts
 Festivals



8'



6'

Water- and Spill-Resistant!



400 denier polyester repels liquids.



Simply blot with a towel to clean up spills.

OUTDOOR FITTED TABLE THROW

This heavy-duty throw can handle wind and spills, making it a perfect choice for outdoor events.

- Stays on the table, even in wind
- Covers four sides of the table
- Artwork is dye sublimated on 400 denier polyester
- Machine-washable
- Flame retardant treated (FR rated for exhibit halls)



Full-Color Full-Bleed

Item #	Description	1	2-5	6-11	12-24
107060	6' Outdoor Fitted Throw	330.00	295.00	275.00	255.00
107061	8' Outdoor Fitted Throw	370.00	330.00	310.00	290.00

White fabric fully dye sublimated with full-color artwork. USD MSRP (C)

Description	Table Size	Full-Bleed Graphic Size	Product Wt.
6'	72"W x 29"H x 29.75"D	View Online Template	3.2 lbs.
8'	96"W x 29"H x 29.75"D	View Online Template	4.2 lbs.



Setup fee: \$20.00(G); no setup fee on orders placed via our website; see page 224 for details. View current graphic templates, assembly videos and instructions on our website. See pages 224-226 for additional information that may apply to your order.

AFTER FINAL PROOF APPROVAL
 PRODUCTION LEAD TIME IS
3 DAYS



5'

4'

3'

31.5" bar-height

31.5" café-height



ROUND TABLE THROW

Whether you're showcasing products or hosting a banquet, this table throw adds style to any occasion.

- Draped, seamless look
- Artwork is dye sublimated on polyester poplin
- Machine-washable and wrinkle-resistant
- Flame retardant treated (FR rated for exhibit halls)



Full-Color Full-Bleed

Item #	Description	1	2-5	6-11	12-24
114040	31.5" Café-Height Round Throw	224.00	206.00	195.00	172.00
114041	31.5" Bar-Height Round Throw	242.00	223.00	211.00	186.00
114042	3' Round Throw	224.00	206.00	195.00	172.00
114043	4' Round Throw	242.00	223.00	211.00	186.00
114044	5' Round Throw	242.00	223.00	211.00	186.00

White fabric fully dye sublimated with full-color artwork. USD MSRP (C)

Description	Table Size	Overhang	Full-Bleed Graphic Size	Product Wt.
31.5" Café-Height	28"H x 31.5"D	27"	View Online Template	1.25 lbs.
31.5" Bar-Height	43"H x 31.5"D	33.25"	View Online Template	1.75 lbs.
3'	28"H x 36"D	27"	View Online Template	1.5 lbs.
4'	28"H x 48"D	25"	View Online Template	1.75 lbs.
5'	28"H x 60"D	19"	View Online Template	1.75 lbs.

Stock Fitted Throw Colors

- Black
- Blueberry PMS 647
- Brown PMS 476
- Burgundy PMS 504
- Charcoal PMS 425
- Gray PMS 422
- Hunter Green PMS 350
- Navy Blue PMS 2767
- Purple PMS Violet
- Red PMS 201
- Royal Blue PMS 661
- White
- Yellow PMS 1235

PMS colors are for reference only and may vary slightly from actual color.



Full-color front only

Full-color full-bleed

FITTED ROUND TABLE THROW

This fitted table throw has a crisp, well-defined shape that makes a big impression at events.

- Fitted for round tables
- Polyester poplin
- Machine-washable and wrinkle-resistant
- Flame retardant treated (FR rated for exhibit halls)



Full-Color Front Only

Item #	Description	1	2-5	6-11	12-24
107040	31.5" Bar-Height Fitted Round Throw	141.00	131.00	121.00	111.00

Stock fabric colors with full-color artwork printed on front. USD MSRP (C)
Artwork cannot exceed maximum size requirements.

Full-Color Full-Bleed

Item #	Description	1	2-5	6-11	12-24
107047	31.5" Bar-Height Fitted Round Throw	269.00	241.00	223.00	204.00

White fabric fully dye sublimated with full-color artwork. USD MSRP (C)

Table Size	Front Only Graphic Size	Viewable Area	Full-Bleed Graphic Size	Product Wt.
43"H x 31.5"D	40"W x 17"H	24"W x 17"H	View Online Template	1.5 lbs.

ROUND FITTED ROUND
AFTER FINAL PROOF APPROVAL
PRODUCTION LEAD TIME IS
2 & 3 DAYS

Setup fee: \$20.00(G); no setup fee on orders placed via our website; see page 224 for details.
View current graphic templates, assembly videos and instructions on our website.
See pages 224-226 for additional information that may apply to your order.



SATIN TABLE THROW

A satin shine adds a touch of elegance to your tables and grabs attention at any event.

- Available in 3-sided or 4-sided throw styles
- Artwork is dye sublimated on shiny polyester satin
- Machine-washable
- Flame retardant treated (FR rated for exhibit halls)



Full-Color Full-Bleed

Item #	Description	1	2-5	6-11	12-24
107072	6' Satin 3-Sided Throw	305.00	270.00	255.00	240.00
107073	8' Satin 3-Sided Throw	330.00	295.00	275.00	255.00
107070	6' Satin 4-Sided Throw	340.00	305.00	285.00	265.00
107071	8' Satin 4-Sided Throw	360.00	320.00	300.00	280.00

White fabric fully dye sublimated with full-color artwork. USD MSRP (C)

Description	Table Size	Full-Bleed Graphic Size	Product Wt. (3-Sided / 4-Sided)
6'	72"W x 29"H x 29.75"D	View Online Template	1.5 lbs. / 2 lbs.
8'	96"W x 29"H x 29.75"D	View Online Template	2 lbs. / 2.5 lbs.



3-sided table throws have a 9" overhang in the back to keep throw from slipping off the table.



4-sided table throws offer full coverage on all sides of the table.



Setup fee: \$20.00(G); no setup fee on orders placed via our website; see page 224 for details. View current graphic templates, assembly videos and instructions on our website. See pages 224-226 for additional information that may apply to your order.

AFTER FINAL PROOF APPROVAL
PRODUCTION LEAD TIME IS
3 DAYS



8'



6'

Stock Enviro Throw Colors

- Black
- Hunter Green PMS 350
- Red PMS 201
- Royal Blue PMS 661
- Yellow PMS 1235

PMS colors are for reference only and may vary slightly from actual color.

ENVIRO TABLE THROW

This environmentally friendly table throw has the same look and feel as our regular polyester poplin throws, but it contains recycled material from discarded water bottles.

- Constructed of polyester poplin that contains 45% recycled material
- Available in 3-sided or 4-sided throw styles
- Draped corners
- Machine-washable and wrinkle-resistant
- Flame Retardant treated (FR rated for exhibit halls)
- Unimprinted throws available online



Full-Color Imprint

Item #	Description	1	2-5	6-11	12-24
107145	6' Enviro 3-Sided Throw	197.00	181.00	171.00	152.00
107147	8' Enviro 3-Sided Throw	212.00	189.00	178.00	165.00
107141	6' Enviro 4-Sided Throw	212.00	189.00	178.00	165.00
107143	8' Enviro 4-Sided Throw	232.00	206.00	195.00	181.00

Stock enviro fabric colors imprinted with any color(s).

USD MSRP (C)

Description	Table Size	Imprint Graphic Size	Product Wt. (3-Sided / 4-Sided)
6'	72"W x 29"H x 29.75"D	50"W x 17"H	2 lbs. / 2.5 lbs.
8'	96"W x 29"H x 29.75"D	50"W x 17"H	2.5 lbs. / 3 lbs.



3-sided table throws have a 9" overhang in the back to keep throw from slipping off the table.



4-sided table throws offer full coverage on all sides of the table.

3 DAYS AFTER FINAL PROOF APPROVAL PRODUCTION LEAD TIME IS

Setup fee: \$20.00(G); no setup fee on orders placed via our website; see page 224 for details. View current graphic templates, assembly videos and instructions on our website. See pages 224-226 for additional information that may apply to your order.



Easy to Clean!



The treated fabric repels liquids.

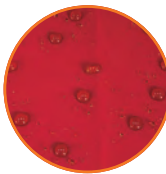

Liquids sit on top of the fabric instead of being absorbed.



Simply blot with a towel to clean up spills.



STAIN-RESISTANT TABLE THROW

Don't stress over the occasional spill. This table throw features a stain-resistant treatment that repels liquids instead of absorbing them.

- Available in 3-sided or 4-sided throw styles
- Draped corners
- Stain-resistant polyester poplin
- Machine-washable and wrinkle-resistant
- Flame retardant treated (FR rated for exhibit halls)
- Unimprinted throws available online



Full-Color Imprint

Item #	Description	1	2-5	6-11	12-24
114125	6' Stain-Resistant 3-Sided Throw	202.00	180.00	170.00	158.00
114127	8' Stain-Resistant 3-Sided Throw	222.00	198.00	186.00	173.00
114121	6' Stain-Resistant 4-Sided Throw	222.00	198.00	186.00	173.00
114123	8' Stain-Resistant 4-Sided Throw	242.00	215.00	203.00	189.00

Stock stain-resistant fabric colors imprinted with any color(s). USD MSRP (C)

Description	Table Size	Imprint Graphic Size	Product WL (3-Sided / 4-Sided)
6'	72"W x 29"H x 29.75"D	50"W x 17"H	2 lbs. / 2.5 lbs.
8'	96"W x 29"H x 29.75"D	50"W x 17"H	2.5 lbs. / 3 lbs.



3-sided table throws have a 9" overhang in the back to keep throw from slipping off the table.



4-sided table throws offer full coverage on all sides of the table.

Stock Stain-Resistant Throw Colors

- Black
- Blueberry PMS 647
- Brown PMS 476
- Burgundy PMS 504
- Charcoal PMS 425
- Gray PMS 422
- Hunter Green PMS 350
- Lime Green PMS 375
- Navy Blue PMS 2767
- Orange PMS 1505
- Purple PMS Violet
- Red PMS 201
- Royal Blue PMS 661
- White
- Yellow PMS 1235

PMS colors are for reference only and may vary slightly from actual color.

Setup fee: \$20.00(G); no setup fee on orders placed via our website; see page 224 for details. View current graphic templates, assembly videos and instructions on our website. See pages 224-226 for additional information that may apply to your order.

AFTER FINAL PROOF APPROVAL
PRODUCTION LEAD TIME IS
3 DAYS



Suggested Uses:
 Promotions
 Charity Events
 Hotels
 School Functions



6' Throw



57" Runner

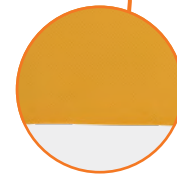

Laser-cut edges for a clean look.

Stock Throw & Runner Colors

- Black
- Blueberry PMS 647
- Brown PMS 476
- Burgundy PMS 504
- Charcoal PMS 425
- Gray PMS 422
- Hunter Green PMS 350
- Lime Green PMS 375*
- Navy Blue PMS 2767
- Orange PMS 1505*
- Purple PMS Violet
- Red PMS 201
- Royal Blue PMS 661
- Yellow PMS 1235

PMS colors are for reference only and may vary slightly from actual color.

**Not available for runners*



3-sided table throws have a 9" overhang in the back to keep throw from slipping off the table.



4-sided table throws offer full coverage on all sides of the table.



Runners can be used alone or with a blank table throw and offer partial front, top and back coverage.

LAZERLINE THROW & RUNNER

These cost-effective throws are laser cut for a crisp finished edge.

- Heat-treated edges will not fray or unravel
- Available in runner, 3-sided or 4-sided throws
- Polyester poplin
- Machine-washable and wrinkle-resistant
- Flame retardant treated (FR rated for exhibit halls)



LazerLine Throw

Item #	Description	1	2-5	6-11	12-24
108213	6' LazerLine 3-Sided Throw Full-Color Front Only	164.00	146.00	137.00	118.00
108214	8' LazerLine 3-Sided Throw Full-Color Front Only	182.00	164.00	146.00	137.00
108201	6' LazerLine 4-Sided Throw Full-Color Front Only	182.00	155.00	146.00	137.00
108202	8' LazerLine 4-Sided Throw Full-Color Front Only	200.00	173.00	164.00	145.00

Stock fabric colors with full-color artwork printed on front. Artwork cannot exceed maximum size requirements.

USD MSRP (C)

Description	Table Size	Front Only Graphic Size	Product Wt. (3-Sided / 4-Sided)
6'	72"W x 29"H x 29.75"D	64"W x 25"H	2 lbs. / 2.5 lbs.
8'	96"W x 29"H x 29.75"D	64"W x 25"H	2.5 lbs. / 3 lbs.

LazerLine Runner

Item #	Description	1	2-5	6-11	12-24
108224	28" LazerLine Runner Full-Color Front Only	118.00	109.00	100.00	91.00
108225	57" LazerLine Runner Full-Color Front Only	146.00	128.00	119.00	110.00

Stock fabric colors with full-color artwork printed on front. Artwork cannot exceed maximum size requirements.

USD MSRP (C)

Description	Finished Size	Front Only Graphic Size	Product Wt.
28"	28"W x 80"D	24"W x 25"H	0.5 lb.
57"	57"W x 80"D	50"W x 25"H	1 lb.

2DAYS
AFTER FINAL PROOF APPROVAL
 PRODUCTION LEAD TIME IS

Setup fee: \$20.00(G); no setup fee on orders placed via our website; see page 224 for details.
 View current graphic templates, assembly videos and instructions on our website.
 See pages 224-226 for additional information that may apply to your order.



Stock Value Lite Throw Colors

- Black
- Hunter Green PMS 350
- Navy Blue PMS 2767
- Red PMS 201
- Royal Blue PMS 661

PMS colors are for reference only and may vary slightly from actual color.

Lightweight, 100% woven polyester pongee.

VALUE LITE TABLE THROW

Value Lite table throws provide a cost-effective option for simple white logo designs.

- Covers four sides of the table
- Draped corners
- Available in five stock fabric colors; imprinted with white only
- Short-term use
- Minimum order quantity of 12
- Unimprinted throws available online



White Imprint

Item #	Description	12-24	25-49	50-74	75-99
116005	6' with White Imprint	94.00	88.00	84.00	73.00
116008	8' with White Imprint	99.00	93.00	88.00	77.00

Stock fabric colors imprinted with white imprint only. Minimum order quantity of 12. USD MSRP (C)

Description	Table Size	Imprint Graphic Size	Product WL
6'	72"W x 29"H x 29.75"D	50"W x 17"H	15 lbs. (Qty 12)
8'	96"W x 29"H x 29.75"D	50"W x 17"H	18 lbs. (Qty 12)



Setup fee: \$20.00(G); no setup fee on orders placed via our website; see page 224 for details. View current graphic templates, assembly videos and instructions on our website. See pages 224-226 for additional information that may apply to your order.

7 DAYS AFTER FINAL PROOF APPROVAL PRODUCTION LEAD TIME IS



57" with full-color front only

28" with full-color full-bleed

Add-On



Table Throw Messenger Bag
Item #220107
See Page 217

STANDARD TABLE RUNNER

This stylish runner lets you add a logo or design to any table.

- Now offering a larger maximum print area for even more ad space
- Available in two widths
- Polyester poplin
- Machine-washable and wrinkle-resistant
- Flame retardant treated (FR rated for exhibit halls)
- Table throw sold separately



Full-Color Front Only

Item #	Description	1	2-5	6-11	12-24
102002	28" Standard Runner	131.00	121.00	111.00	101.00
102014	57" Standard Runner	162.00	142.00	132.00	122.00

Stock fabric colors with full-color artwork printed on front. USD MSRP (C)
Artwork cannot exceed maximum size requirements.

Full-Color Full-Bleed

Item #	Description	1	2-5	6-11	12-24
102010	28" Standard Runner	190.00	165.00	160.00	145.00
102022	57" Standard Runner	220.00	195.00	180.00	165.00

White fabric fully dye sublimated with full-color artwork. USD MSRP (C)

Description	Finished Size	Front Only Graphic Size	Dye Sub Graphic Size	Product Wt.
28"	28"W x 80"D	24"W x 25"H	View Online Template	0.5 lb.
57"	57"W x 80"D	50"W x 25"H	View Online Template	1 lb.

Stock Standard Runner Colors

- Black
- Blueberry PMS 647
- Brown PMS 476
- Burgundy PMS 504
- Charcoal PMS 425
- Gray PMS 422
- Hunter Green PMS 350
- Navy Blue PMS 2767
- Purple PMS Violet
- Red PMS 201
- Royal Blue PMS 661
- White
- Yellow PMS 1235

PMS colors are for reference only and may vary slightly from actual color.



Full-color front only



Full-color full-bleed

2DAYS
AFTER FINAL PROOF APPROVAL
PRODUCTION LEAD TIME IS

Setup fee: \$20.00(G); no setup fee on orders placed via our website; see page 224 for details.
View current graphic templates, assembly videos and instructions on our website.
See pages 224-226 for additional information that may apply to your order.

ACCENT TABLE RUNNER

The satin material of this runner adds a touch of elegance to any tabletop.

- Available in two widths
- Constructed of polyester satin with satin trim
- Satin trim available in three colors
- Machine-washable
- Flame retardant treated (FR rated for exhibit halls)
- Table throw sold separately
- Unimprinted runners available online



57" with full-color full-bleed finished with white satin trim



Full-color imprint



Full-color full-bleed

Full-Color Imprint

Item #	Description	1	2-5	6-11	12-24
103002	28" Accent Runner	172.00	162.00	152.00	142.00
103014	57" Accent Runner	202.00	192.00	172.00	162.00

Stock fabric colors with full-color artwork printed on front. USD MSRP (C)

Full-Color Full-Bleed

Item #	Description	1	2-5	6-11	12-24
103010	28" Accent Runner	250.00	240.00	230.00	220.00
103022	57" Accent Runner	285.00	275.00	255.00	250.00

White fabric fully dye sublimated with full-color artwork. USD MSRP (C)

Description	Finished Size	Imprint Graphic Size	Dye Sub Graphic Size	Product Wt.
28"	28"W x 80"D	24"W x 17"H	View Online Template	0.5 lb.
57"	57"W x 80"D	50"W x 17"H	View Online Template	1 lb.

Stock Accent Runner Colors

- Black
- Royal Blue PMS 661
- White

Stock Trim Colors

- Black
- Red PMS 200
- White

PMS colors are for reference only and may vary slightly from actual color.

LATERAL TABLE RUNNER

This runner drapes across the width of the table so it won't cover a design or logo printed on the front of your table throw.

- Polyester poplin
- Machine-washable and wrinkle-resistant
- Flame retardant treated (FR rated for exhibit halls)
- Table throw sold separately



125" runner with full-color top only shown on an 6' Standard throw with full-color front only (sold separately; see page 10)



Full-color top only



Full-color full-bleed

Full-Color Top Only

Item #	Description	1	2-5	6-11	12-24
105111	125" Lateral Runner	162.00	149.00	141.00	125.00
105116	149" Lateral Runner	192.00	177.00	167.00	148.00

Stock fabric colors imprinted with any color(s). USD MSRP (C)

Full-Color Full-Bleed

Item #	Description	1	2-5	6-11	12-24
105114	125" Lateral Runner	250.00	225.00	210.00	195.00
105119	149" Lateral Runner	290.00	260.00	245.00	225.00

White fabric fully dye sublimated with full-color artwork. USD MSRP (C)

Description	Finished Size	Top Only Graphic Size	Dye Sub Graphic Size	Product Wt.
125"	125"W x 28"D	50"W x 17"H	View Online Template	0.8 lb.
149"	149"W x 28"D	50"W x 17"H	View Online Template	1 lb.

Stock Lateral Runner Colors

- Black
- Navy Blue PMS 2767
- Red PMS 201
- Royal Blue PMS 661
- White

PMS colors are for reference only and may vary slightly from actual color.

Setup fee: \$20.00(G); no setup fee on orders placed via our website; see page 224 for details. View current graphic templates, assembly videos and instructions on our website. See pages 224-226 for additional information that may apply to your order.

LATERAL ACCENT
AFTER FINAL PROOF APPROVAL
PRODUCTION LEAD TIME IS
2 3 DAYS



1. Optimum page 36 | 2. Economy page 31 | 3. Deluxe Pro page 34

RETRACTABLE BANNERS

When choosing a retractor **have you considered...**

- **USE** - Will this product be used on a floor or on a tabletop?
- **FLEXIBILITY** - Will your graphic be permanent, or will you be swapping it out frequently?
- **FREQUENCY** - How often will your retractor be set up and taken down?
- **LOCATION** - Will your retractor be used indoors or outdoors?
- **MESSAGE** - Do you want a single-sided or double-sided display?

RETRACTABLE BANNER COMPARISON CHART

★ = Best Sellers		PG	VIEWABLE GRAPHIC	COST	TELESCOPING POLE	CHANGEABLE BANNER	ADJUSTABLE TENSION	2-SIDED OPTION	BANNER MEDIA (See Definitions Below)	RCAT RATING (Minimum Retractions)	HARDWARE WARRANTY
GOOD	Small Mini Promo	45	8.25"W x 12"H	\$					Polypropylene Media	NA	6 Months
	Large Mini Promo	45	11.75"W x 16.5"H	\$					Polypropylene Media	NA	6 Months
	Deluxe Mini	45	8.25"W x 16.25"H	\$					Polypropylene Media	NA	6 Months
	31.5" Ideal	28	31.25"W x 79.5"H	\$				✓	Polypropylene Media	25	2 Months
	33.5" Ideal	28	33.25"W x 79.5"H	\$				✓		25	2 Months
	31.5" Value	29	31.5"W x 79.5"H	\$					Polypropylene Media No-Curl Hybrid Media	50	6 Months
	33.5" Value	29	33.5"W x 79.5"H	\$						50	6 Months
	36" Value	29	36"W x 79.5"H	\$						50	6 Months
	Tabletop Economy ★	30	24"W x 35.5"H	\$					No-Curl Hybrid Media No-Curl Opaque Fabric	100	1 Year
	24" Economy ★	30	24"W x 78.5"H	\$						100	1 Year
	31.5" Economy ★	30	31.5"W x 78.5"H	\$						100	1 Year
	33.5" Economy ★	30	33.5"W x 78.5"H	\$						100	1 Year
	36" Economy ★	30	36"W x 78.5"H	\$						100	1 Year
	48" Economy ★	30	47.25"W x 78.5"H	\$						100	1 Year
31.5" Economy Plus ★	32	31.5"W x 58"-78.5"H	\$	✓	✓			No-Curl Hybrid Media No-Curl Opaque Fabric Dry-Erase Media		150	2 Years
33.5" Economy Plus ★	32	33.5"W x 58"-78.5"H	\$	✓	✓					150	2 Years
24" Stratus ★	33	24"W x 64.375"-78.5"H	\$	✓	✓			No-Curl Hybrid Media No-Curl Opaque Fabric Dry-Erase Media		200	2 Years
31.5" Stratus ★	33	31.5"W x 64.375"-78.5"H	\$	✓	✓					200	2 Years
33.5" Stratus ★	33	33.5"W x 64.375"-78.5"H	\$	✓	✓				200	2 Years	
36" Stratus ★	33	36"W x 64.375"-78.5"H	\$	✓	✓				200	2 Years	
48" Stratus ★	33	47.75"W x 64.375"-78.5"H	\$	✓	✓				200	2 Years	
33.5" Deluxe Pro ★	34	33.5"W x 61.5"-79.5"H	\$	✓	✓		✓		No-Curl Opaque Fabric Dry-Erase Media	200	2 Years
46.5" Deluxe Pro ★	34	46.5"W x 61.5"-79.5"H	\$	✓	✓		✓	200		2 Years	
31" Change Agent	35	31"W x 69"-80"H	\$	✓	✓			No-Curl Opaque Fabric Dry-Erase Media	300	2 Years	
33" Change Agent	35	33"W x 69"-80"H	\$	✓	✓				300	2 Years	
36" Change Agent	35	36"W x 69"-80"H	\$	✓	✓				300	2 Years	
24" Optimum	36	23.75"W x 56.75"-78.75"H	\$	✓	✓		✓	No-Curl Opaque Fabric	800	3 Years	
31.5" Optimum	36	31.5"W x 56.75"-78.75"H	\$	✓	✓		✓		800	3 Years	
40" Optimum	36	40"W x 56.75"-78.75"H	\$	✓	✓		✓		800	3 Years	
Superb ★	37	33.5"W x 31.5"-78"H	\$	✓	✓	✓			No-Curl Hybrid Media	800	Lifetime
XChange	37	33"W x 62.625"-79"H	\$	✓	✓	✓		No-Curl Hybrid Media	800	3 Years	
MagnaChange	38	33.5"W x 26"-90"H	\$	✓	✓	✓		No-Curl Opaque Fabric	800	3 Years	
Lumos	39	33.5"W x 26"-90"H	\$	✓	✓	✓		No-Curl Opaque Fabric	800	3 Years	
Tabletop MagnaLink	45	15.75"W x 42.25"-50" H	\$	✓	✓	✓		No-Curl Fabric	800	3 Years	
16" MagnaLink	40	15.75"W x 82.25"-90"H	\$	✓	✓	✓			800	3 Years	
33.5" MagnaLink	40	33.375"W x 29.875"-90"H	\$	✓	✓	✓			800	3 Years	
60" MagnaLink	40	59"W x 29.875"-90"H	\$	✓	✓	✓			800	3 Years	
SPECIALTY	Outdoor	41	31.5"W x 53.75"-79.5"H	\$	✓				13 oz. Scrim Vinyl	150	1 Year
	Outdoor Trek Lite	41	33.25"W x 77.25"H	\$				✓	13 oz. Scrim Vinyl	250	1 Year
	NEW! Element	42	33.25"W x 37"-80.25"H	\$	✓			✓	13 oz. Scrim Vinyl	150	1 Year
	NEW! 4' Outdoor A-Frame	43	47.5"W x 40"H	\$				✓	13 oz. Scrim Vinyl	100	1 Year
	NEW! 5' Outdoor A-Frame	43	59.25"W x 40"H	\$				✓	No-Curl Opaque Fabric	100	1 Year
	5' Jumbo Wide	44	59.75"W x 78.75"H	\$					No-Curl Fabric 13 oz. Smooth Scrim Vinyl	100	1 Year
	6' Jumbo Wide	44	71.75"W x 78.75"H	\$						100	1 Year
8' Jumbo Wide	44	94.75"W x 78.75"H	\$					100		1 Year	



AMERICA'S FINEST RETRACTOR

To guarantee superior quality, we have developed an RCAT (Retractor Calibration Assessment Test) machine that assesses retractable banner components. Each retractor is tested and rated to a minimum number of times it will extend and retract with normal use, helping you find a retractor that meets your exact needs. The RCAT rating certification lets you have confidence in your retractable banner display, no matter which one you choose.



TOP SELLER

TITAN™ NO-CURL HYBRID MEDIA

Anti-curl properties for a taut banner.

BANNER MEDIA

<p>TITAN™ NO-CURL OPAQUE FABRIC</p> <p>High-quality fabric that prevents curling. Silver backing makes it opaque.</p>	<p>TITAN™ NO-CURL FABRIC</p> <p>Lightweight, no-glare fabric prevents curling.</p>	<p>DRY-ERASE MEDIA</p> <p>Smooth, glossy surface that can be written or drawn on with a dry-erase marker.</p>	<p>TITAN™ 13 OZ. SMOOTH SCRIM VINYL</p> <p>Smooth vinyl material, ideal for high-quality graphics.</p>	<p>TITAN™ 13 OZ. SCRIM VINYL</p> <p>Durable vinyl repels water and cleans easily for extended outdoor use.</p>	<p>TITAN™ POLYPROPYLENE MEDIA</p> <p>Tear-resistant matte media for temporary use.</p>
--	---	--	---	---	---



33.5" single

31.5" double



IDEAL RETRACTOR

The Ideal Retractor is designed from the ground up to be a quick, simple solution for short-term promotional applications.

- Lightweight, portable base
- Three-section shock cord pole
- Artwork is printed on tear-resistant Titan™ polypropylene media
- Banner is printed on double-sided; double-sided option includes two banners



Ideal Retractor

Item #	Description	1	2-5	6-11	12-24
261150	31.5" Single Kit	113.00	106.00	101.00	94.00
261156	31.5" Double Kit	224.00	220.00	198.00	195.00
261153	33.5" Single Kit	124.00	117.00	110.00	103.00
261158	33.5" Double Kit	244.00	240.00	216.00	212.00

Kit Includes: Hardware, Installed Banner(s) and Soft Carry Case

USD MSRP (C)

Description	Product Size (Single / Double)	Finished Graphic Size	Product Wt. (Single / Double)	Media
31.5"	32.25"W x 82.25"H x 10.25"D / 8"D	31.25"W x 79.5"H	4.6 lbs. / 9.25 lbs.	Titan™ Polypropylene Media
33.5"	34.25"W x 82.25"H x 10.25"D / 8"D	33.25"W x 79.5"H	5 lbs. / 9.5 lbs.	Titan™ Polypropylene Media



Double-sided retractor features a center-mounted pole with twin banner hooks on top.



Shock cord pole makes setup and teardown easy.



Lightweight aluminum base features plastic ends and is available in single- and double-banner options.

AFTER FINAL PROOF APPROVAL PRODUCTION LEAD TIME IS
1 DAY

Setup fee: \$20.00(G); no setup fee on orders placed via our website; see page 224 for details. View current graphic templates, assembly videos and instructions on our website. See pages 224-226 for additional information that may apply to your order.

Suggested Uses:
Airports
Sales Campaigns
Lobbies
Trade Shows

RETRACTABLE BANNERS



VALUE RETRACTOR

The Value Retractor is a cost-conscious option for your portable signage needs.

- Banner available in Titan™ polypropylene media or Titan™ no-curl hybrid media
- Two swivel feet for stability
- Available in three widths



Value Retractor

Item #	Description	1	2-5	6-11	12-24
262240	31.5" Polypropylene Media Kit	167.00	157.00	149.00	139.00
262241	31.5" No-Curl Hybrid Media Kit	215.00	202.00	191.00	178.00
262243	33.5" Polypropylene Media Kit	183.00	172.00	163.00	152.00
262244	33.5" No-Curl Hybrid Media Kit	240.00	226.00	214.00	199.00
262246	36" Polypropylene Media Kit	209.00	196.00	186.00	173.00
262247	36" No-Curl Hybrid Media Kit	271.00	255.00	241.00	225.00

Kit Includes: Hardware, Installed Banner and Soft Carry Case USD MSRP (C)

Description	Product Size	Finished Graphic Size	Product Wt.
31.5"	34"W x 82"H x 15"D	31.5"W x 79.5"H	7 lbs.
33.5"	35.75"W x 82"H x 15"D	33.5"W x 79.5"H	7.25 lbs.
36"	38.5"W x 82"H x 15"D	36"W x 79.5"H	7.6 lbs.



Shock cord pole makes setup and teardown easy.



Lightweight aluminum base with plastic ends.



Setup fee: \$20.00(G); no setup fee on orders placed via our website; see page 224 for details.
View current graphic templates, assembly videos and instructions on our website.
See pages 224-226 for additional information that may apply to your order.

AFTER FINAL PROOF APPROVAL
PRODUCTION LEAD TIME IS
2 DAYS

ECONOMY RETRACTOR

The popular Economy Retractor is versatile and budget-friendly, making it a great option for the cost-conscious marketer.

- Lightweight aluminum base
- Banner available in Titan™ no-curl hybrid media or Titan™ no-curl opaque fabric



Suggested Uses:
 Trade Shows
 Store Promotions
 Meetings
 School Functions



Add-Ons



Economy Retractor Hard Case

Item #	Description	1	2-5	6-11	12-24
220129	Carrying Case	65.00	63.00	62.00	57.00
				USD MSRP (C)	

Ultimate LED Single Light Kit

Item #	Description	1	2-5	6-11	12-24
150120	Single Light Kit	144.00	140.00	135.00	131.00
				USD MSRP (C)	



Tabletop shown on a 6' Standard throw (sold separately; see page 10)

Economy Retractor

Item #	Description	1	2-5	6-11	12-24
261130	Tabletop No-Curl Hybrid Media Kit	173.00	161.00	150.00	138.00
262160	Tabletop No-Curl Opaque Fabric Kit	173.00	161.00	150.00	138.00
261132	24" No-Curl Hybrid Media Kit (Black Hardware Only)	237.00	226.00	216.00	197.00
262161	24" No-Curl Opaque Fabric Kit (Black Hardware Only)	237.00	226.00	216.00	197.00
261134	31.5" No-Curl Hybrid Media Kit	271.00	251.00	240.00	228.00
262162	31.5" No-Curl Opaque Fabric Kit	271.00	251.00	240.00	228.00
261136	33.5" No-Curl Hybrid Media Kit	295.00	275.00	263.00	243.00
262163	33.5" No-Curl Opaque Fabric Kit	295.00	275.00	263.00	243.00
261138	36" No-Curl Hybrid Media Kit	327.00	314.00	302.00	290.00
262164	36" No-Curl Opaque Fabric Kit	327.00	314.00	302.00	290.00
261140	48" No-Curl Hybrid Media Kit	379.00	365.00	352.00	338.00
262165	48" No-Curl Opaque Fabric Kit	379.00	365.00	352.00	338.00

Kit Includes: Hardware, Installed Banner and Soft Carry Case USD MSRP (C)

Description	Product Size	Finished Graphic Size	Product Wt.
Tabletop	24.75"W x 39"H x 11"D	24"W x 35.5"H	5.5 lbs.
24"	24.75"W x 83.5"H x 11"D	24"W x 78.5"H	6 lbs.
31.5"	32"W x 83.5"H x 15"D	31.5"W x 78.5"H	7 lbs.
33.5"	34"W x 83.5"H x 15"D	33.5"W x 78.5"H	7.25 lbs.
36"	36.5"W x 83.5"H x 15"D	36"W x 78.5"H	8.5 lbs.
48"	48"W x 83.5"H x 15"D	47.25"W x 78.5"H	11.25 lbs.

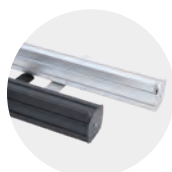
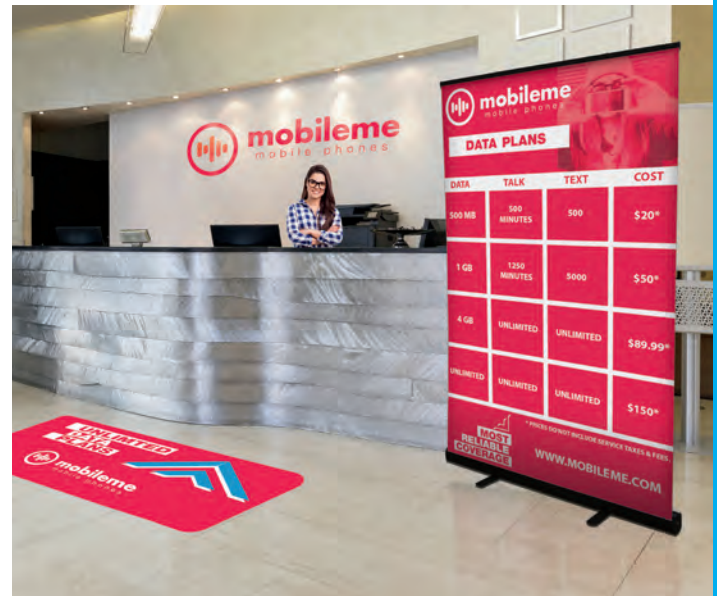

Hardware available in silver or black (24" available in black only).



Shock cord pole makes setup and teardown easy.



Banner rail easily attaches to the top of the pole for quick setup.



Two swivel feet for stability.

HARDWARE ONLY LEAD TIME: SHIPS SAME DAY WHEN ORDERED BEFORE 2 PM CENTRAL
 Setup fee: \$20.00(G); no setup fee on orders placed via our website; see page 224 for details.
 View current graphic templates, assembly videos and instructions on our website.
 See pages 224-226 for additional information that may apply to your order.

AFTER FINAL PROOF APPROVAL
 PRODUCTION LEAD TIME IS
2 DAYS



33.5"

31.5"



Dry-Erase Media

Dry-erase media is both fun and functional. It features a glossy surface that has the write-on/wipe-off utility of a dry-erase board (dry-erase markers not included).



Banner rail easily attaches to the top of the pole for quick setup.



Hook-and-loop fasteners make banners easy to swap out.



Heavy-duty aluminum base available in silver.



ECONOMY PLUS RETRACTOR

This display is as reliable as the popular Economy Retractor, but it includes some great additional features, like improved durability.

- Available in two widths
- Single-footed design keeps the retractor stable while maintaining a low profile
- Flip-lever telescoping pole makes setup and adjustment simple
- Banner available in Titan™ no-curl hybrid media, Titan™ no-curl opaque fabric or dry-erase media



Economy Plus Retractor

Item #	Description	1	2-5	6-11	12-24
261012	31.5" No-Curl Hybrid Media Kit	310.00	288.00	273.00	262.00
262180	31.5" No-Curl Opaque Fabric Kit	310.00	288.00	273.00	262.00
262191	31.5" Dry-Erase Media Kit	310.00	288.00	273.00	262.00
261002	33.5" No-Curl Hybrid Media Kit	338.00	315.00	301.00	278.00
262181	33.5" No-Curl Opaque Fabric Kit	338.00	315.00	301.00	278.00
262192	33.5" Dry-Erase Media Kit	338.00	315.00	301.00	278.00

Kit Includes: Hardware, Installed Banner and Soft Carry Case USD MSRP (C)

Description	Product Size	Finished Graphic Size	Product Wt.
31.5"	32"W x 62"-82.5"H x 15"D	31.5"W x 58"-78.5"H	7 lbs.
33.5"	34"W x 62"-82.5"H x 15"D	33.5"W x 58"-78.5"H	7.5 lbs.

AFTER FINAL PROOF APPROVAL
PRODUCTION LEAD TIME IS
2 DAYS

Setup fee: \$20.00(G); no setup fee on orders placed via our website; see page 224 for details.
View current graphic templates, assembly videos and instructions on our website.
See pages 224-226 for additional information that may apply to your order.



STRATUS RETRACTOR

The Stratus Retractor's streamlined base features a low center of gravity to keep it stable, eliminating the need for fold-out feet.

- Durable, lightweight construction
- Banner available in Titan™ no-curl hybrid media, Titan™ no-curl opaque fabric or dry-erase media



Stratus Retractor

Item #	Description	1	2-5	6-11	12-24
262070	24" No-Curl Hybrid Media Kit	263.00	247.00	234.00	218.00
262150	24" No-Curl Opaque Fabric Kit	263.00	247.00	234.00	218.00
262206	24" Dry-Erase Media Kit	263.00	247.00	234.00	218.00
262072	31.5" No-Curl Hybrid Media Kit	316.00	297.00	281.00	262.00
262151	31.5" No-Curl Opaque Fabric Kit	316.00	297.00	281.00	262.00
262207	31.5" Dry-Erase Media Kit	316.00	297.00	281.00	262.00
262074	33.5" No-Curl Hybrid Media Kit	326.00	304.00	290.00	268.00
262152	33.5" No-Curl Opaque Fabric Kit	326.00	304.00	290.00	268.00
262208	33.5" Dry-Erase Media Kit	326.00	304.00	290.00	268.00
262076	36" No-Curl Hybrid Media Kit	379.00	356.00	337.00	315.00
262153	36" No-Curl Opaque Fabric Kit	379.00	356.00	337.00	315.00
262209	36" Dry-Erase Media Kit	379.00	356.00	337.00	315.00
262078	48" No-Curl Hybrid Media Kit	421.00	396.00	375.00	349.00
262154	48" No-Curl Opaque Fabric Kit	421.00	396.00	375.00	349.00
262210	48" Dry-Erase Media Kit	421.00	396.00	375.00	349.00

Kit Includes: Hardware, Installed Banner and Soft Carry Case USD MSRP (C)

Description	Product Size	Finished Graphic Size	Product Wt.
24"	25.25"W x 67.5"-81.625"H x 7.125"D	24"W x 64.375"-78.5"H	8.75 lbs.
31.5"	33"W x 67.5"-81.625"H x 7.125"D	31.5"W x 64.375"-78.5"H	11.25 lbs.
33.5"	34.25"W x 67.5"-81.75"H x 7.25"D	33.5"W x 64.375"-78.5"H	12 lbs.
36"	37.25"W x 67.5"-81.75"H x 7.25"D	36"W x 64.375"-78.5"H	12.5 lbs.
48"	49.5"W x 67.5"-81.75"H x 7.25"D	47.75"W x 64.375"-78.5"H	17.25 lbs.



Aluminum base features chrome end caps and has a low center of gravity.

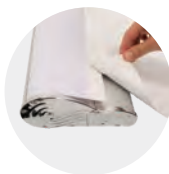

Hook-and-loop fasteners make banners easy to swap out.



Shock cord pole with telescoping flip-lever extension makes setup and adjustment simple.

Dry-Erase Media

Dry-erase media is both fun and functional. It features a glossy surface that has the write-on/wipe-off utility of a dry-erase board (dry-erase markers not included).



Setup fee: \$20.00(G); no setup fee on orders placed via our website; see page 224 for details. View current graphic templates, assembly videos and instructions on our website. See pages 224-226 for additional information that may apply to your order.

AFTER FINAL PROOF APPROVAL
PRODUCTION LEAD TIME IS
2 DAYS



46.5" double

33.5" single



Dry-Erase Media

Dry-erase media is both fun and functional. It features a glossy surface that has the write-on/wipe-off utility of a dry-erase board (dry-erase markers not included).

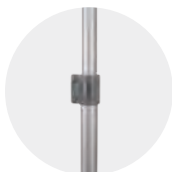

Flip-lever telescoping pole makes setup and adjustment simple.



Hook-and-loop fasteners make banners easy to swap out.

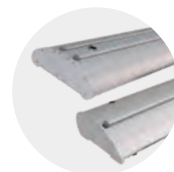

Streamlined base is available in single- and double-banner options.

NO-CURL OPAQUE FABRIC | DRY-ERASE MEDIA
1 OR 2 DAYS
 AFTER FINAL PROOF APPROVAL
 PRODUCTION LEAD TIME IS



DELUXE PRO RETRACTOR

The Deluxe Pro Retractor features a rounded base with durable aluminum end caps, and swapping out graphics is a breeze with the hook-and-loop banner system.

- Banner available in Titan™ no-curl opaque fabric or dry-erase media
- Banner is printed single-sided; double-sided option includes two banners



Deluxe Pro Retractor

Item #	Description	1	2-5	6-11	12-24
262250	33.5" Single No-Curl Opaque Fabric Kit	341.00	321.00	303.00	283.00
262251	33.5" Double No-Curl Opaque Fabric Kit	499.00	487.00	441.00	429.00
262202	33.5" Single Dry-Erase Media Kit	341.00	321.00	303.00	283.00
262203	33.5" Double Dry-Erase Media Kit	499.00	487.00	441.00	429.00
262254	46.5" Single No-Curl Opaque Fabric Kit	382.00	359.00	340.00	317.00
262255	46.5" Double No-Curl Opaque Fabric Kit	596.00	581.00	528.00	513.00
262204	46.5" Single Dry-Erase Media Kit	382.00	359.00	340.00	317.00
262205	46.5" Double Dry-Erase Media Kit	596.00	581.00	528.00	513.00

Kit Includes: Hardware, Installed Banner(s) and Soft Carry Case USD MSRP (C)

Description	Product Size (Single / Double)	Finished Graphic Size	Product Wt. (Single / Double)
33.5"	34.75"W x 65.25"-83.25"H x 8.5"D / 9.25"D	33.5"W x 61.5"-79.5"H	12.25 lbs. / 16 lbs.
46.5"	48.5"W x 65.25"-83.25"H x 8.5"D / 9.25"D	46.5"W x 61.5"-79.5"H	16.75 lbs. / 22.5 lbs.

Setup fee: \$20.00(G); no setup fee on orders placed via our website; see page 224 for details.
 View current graphic templates, assembly videos and instructions on our website.
 See pages 224-226 for additional information that may apply to your order.



CHANGE AGENT RETRACTOR

This retractor's base has a high-end look, and its hook-and-loop banner system allows banners to be frequently swapped with very little effort.

- Banner available in Titan™ no-curl opaque fabric or dry-erase media
- Available in three widths



Change Agent Retractor

Item #	Description	1	2-5	6-11	12-24
263200	31" No-Curl Opaque Fabric Kit	325.00	306.00	289.00	270.00
262195	31" Dry-Erase Media Kit	325.00	306.00	289.00	270.00
263202	33" No-Curl Opaque Fabric Kit	358.00	337.00	319.00	297.00
262196	33" Dry-Erase Media Kit	358.00	337.00	319.00	297.00
263204	36" No-Curl Opaque Fabric Kit	368.00	346.00	328.00	305.00
262197	36" Dry-Erase Media Kit	368.00	346.00	328.00	305.00
Kit Includes: Hardware, Installed Banner and Soft Carry Case		USD MSRP (C)			

Description	Product Size	Finished Graphic Size	Product Wt.
31"	33"W x 72"-83"H x 9.5"D	31"W x 69"-80"H	14.25 lbs.
33"	35"W x 72"-83"H x 9.5"D	33"W x 69"-80"H	15 lbs.
36"	37.5"W x 72"-83"H x 9.5"D	36"W x 69"-80"H	15.5 lbs.



Base available in silver with aluminum ends.



Twist-lock telescoping pole makes setup and adjustment simple.



Hook-and-loop fasteners make banners easy to swap out.

Dry-Erase Media

Dry-erase media is both fun and functional. It features a glossy surface that has the write-on/wipe-off utility of a dry-erase board (dry-erase markers not included).



Setup fee: \$20.00(G); no setup fee on orders placed via our website; see page 224 for details. View current graphic templates, assembly videos and instructions on our website. See pages 224-226 for additional information that may apply to your order.

AFTER FINAL PROOF APPROVAL
PRODUCTION LEAD TIME IS
2 DAYS



40" double

31.5" double

24" single



OPTIMUM RETRACTOR

These top-of-the-line retractors are built to last, making them perfect for long-term, frequent use.

- Heavy-duty internal coil stands up to repeated use
- Available in three widths
- Artwork is printed on Titan™ no-curl opaque fabric
- Banner is printed single-sided; double-sided option includes two banners



Optimum Retractor

Item #	Description	1	2-5	6-11	12-24
262130	24" Single Kit	378.00	364.00	344.00	330.00
262131	24" Double Kit	540.00	534.00	494.00	488.00
262132	31.5" Single Kit	424.00	408.00	389.00	374.00
262133	31.5" Double Kit	612.00	605.00	560.00	553.00
262134	40" Single Kit	544.00	525.00	503.00	484.00
262135	40" Double Kit	765.00	759.00	705.00	699.00

Kit Includes: Hardware, Installed Banner(s) and Soft Carry Case USD MSRP (C)

Description	Product Size	Finished Graphic Size	Product Wt. (Single / Double)	Media
24"	25"W x 59.5"-81.5"H x 7"D	23.75"W x 56.75"-78.75"H	12.55 lbs. / 13.1 lbs.	Titan™ No-Curl Opaque Fabric
31.5"	32.75"W x 59.5"-81.5"H x 7"D	31.5"W x 56.75"-78.75"H	15.1 lbs. / 15.8 lbs.	Titan™ No-Curl Opaque Fabric
40"	41.25"W x 59.5"-81.5"H x 7"D	40"W x 56.75"-78.75"H	18.1 lbs. / 19 lbs.	Titan™ No-Curl Opaque Fabric



Banner rail easily attaches to the top of the pole for quick setup.



Hook-and-loop fasteners make banners easy to swap out.



Shock cord pole with telescoping flip-lever extension makes setup and adjustment simple.



Durable aluminum base can hold a banner on each side to double your ad space.

AFTER FINAL PROOF APPROVAL
PRODUCTION LEAD TIME IS
2 DAYS

Setup fee: \$20.00(G); no setup fee on orders placed via our website; see page 224 for details.
View current graphic templates, assembly videos and instructions on our website.
See pages 224-226 for additional information that may apply to your order.

Suggested Uses:

- Colleges
- Restaurants
- Lobbies
- Airports

SUPERB RETRACTOR

This retractor features a flip-open base for easy graphic changes, and its hardware is built to last a lifetime.

- Durable construction makes this a long-lasting option
- Artwork is printed on Titan™ no-curl hybrid media



Superb Retractor

Item #	Description	1	2-5	6-11	12-24
261118	Kit	435.00	419.00	387.00	374.00
262023	Banner and Roller	259.00	249.00	230.00	221.00

Kit Includes: Hardware, Installed Banner and Soft Carry Case USD MSRP (C)

Product Size	Finished Graphic Size	Product Wt.	Media
35.5"W x 37"-80.5"H x 7.75"D	33.5"W x 31.5"-78"H	8 lbs.	Titan™ No-Curl Hybrid Media



Low-profile base is available with black or silver ends.



Flip-lever telescoping pole makes setup and adjustment simple.



Flip-open base allows for easy banner changes.



RETRACTABLE BANNERS

Suggested Uses:

- Meetings
- Retail Stores
- Conferences
- Doctor's Office

XCHANGE RETRACTOR

The XChange Retractor lets you easily slide graphics in and out. It is affordable and durable, a great choice for repeated use.

- A knob on the base lets you adjust tension without tools
- Artwork is printed on Titan™ no-curl hybrid media



XChange Retractor

Item #	Description	1	2-5	6-11	12-24
263050	Kit	380.00	357.00	338.00	315.00
263052	Banner Only Kit	153.00	144.00	136.00	127.00

Kit Includes: Hardware, Installed Banner and Soft Carry Case USD MSRP (C)
Banner Only Kit Includes: Banner with attached Top Rail and Bottom Strip

Product Size	Finished Graphic Size	Product Wt.	Media
35.5"W x 65.25"-81.5"H x 8.75"D	33"W x 62.625"-79"H	12 lbs.	Titan™ No-Curl Hybrid Media



A knob on the base lets you adjust tension without tools.



A plastic rail on the banner slides in and out of the flip-open base for quick banner changes.



Aluminum footless base comes in silver.



Flip-lever telescoping pole makes setup and adjustment simple.



Setup fee: \$20.00(G); no setup fee on orders placed via our website; see page 224 for details. View current graphic templates, assembly videos and instructions on our website. See pages 224-226 for additional information that may apply to your order.

SUPERB XCHANGE AFTER FINAL PROOF APPROVAL PRODUCTION LEAD TIME IS **1 to 2 DAYS**



MAGNACHANGE RETRACTOR

This retractor stands out with a unique, stylish aesthetic. The banner attaches magnetically to the roller cartridge, and the cartridge itself is easily interchangeable so you can change the banner frequently.

- Artwork is printed on Titan™ no-curl opaque fabric
- A knob on the base lets you adjust tension without tools
- Flip-lever telescoping pole makes setup and adjustment simple



MagnaChange Retractor

Item #	Description	1	2-5	6-11	12-24
261180	Kit	520.00	489.00	463.00	432.00
261184	Cartridge Kit	226.00	212.00	201.00	188.00
Kit Includes: Hardware, Installed Banner and Soft Carry Case					
Cartridge Kit Includes: Cartridge with Installed Banner and Snap Rail					
		USD MSRP (C)			
Product Size	Finished Graphic Size	Product Wt.	Media		
37.5"W x 31"-95"H x 9.5"D	33.5"W x 26"-90"H	16.25 lbs.	Titan™ No-Curl Opaque Fabric		

Add-On

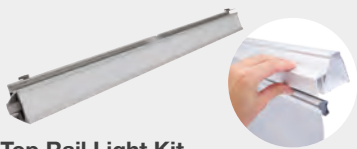

Top Rail Light Kit

Item #	1	2-5	6-11	12-24
261235	131.00	123.00	117.00	109.00
USD MSRP (C)				

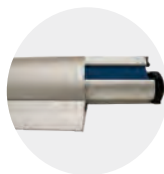

Graphic roller cartridge slides in and out of the end of the base so it can be changed easily.

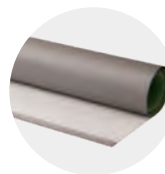

Metal rail on the bottom of the banner attaches to magnets inside the graphic roller cartridge.



Cam lock secures the pole to the base.

AFTER FINAL PROOF APPROVAL
PRODUCTION LEAD TIME IS
2 DAYS

HARDWARE ONLY LEAD TIME: SHIPS SAME DAY WHEN ORDERED BEFORE 2 PM CENTRAL

Setup fee: \$20.00(G); no setup fee on orders placed via our website; see page 224 for details.

View current graphic templates, assembly videos and instructions on our website.

See pages 224-226 for additional information that may apply to your order.



LIGHTS UP!

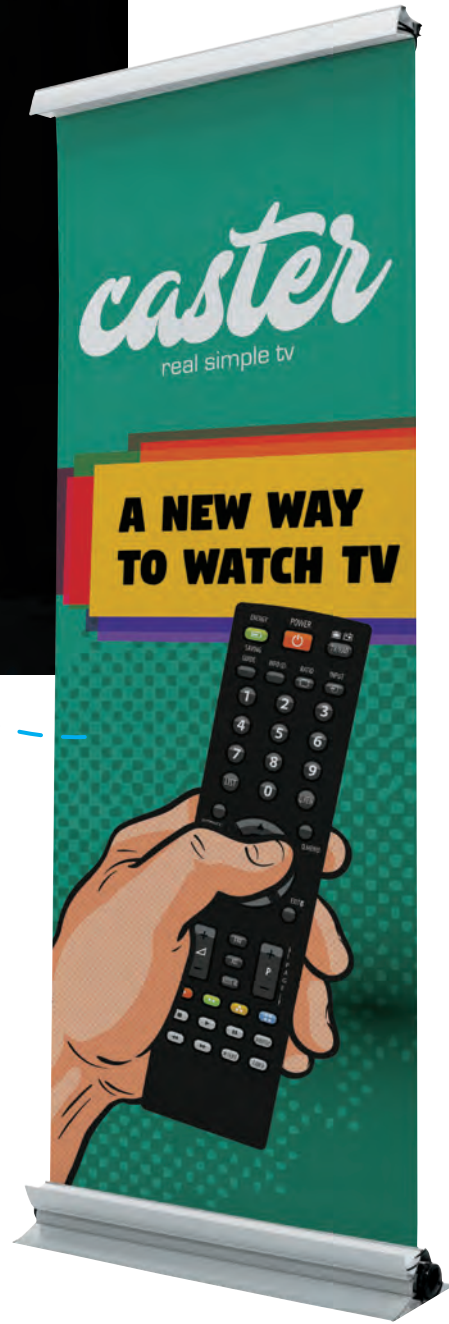

LUMOS RETRACTOR

This retractable banner is illuminated from both the top and bottom. What a bright idea!

- Artwork is printed on Titan™ no-curl opaque fabric
- Flip lever telescoping pole makes setup and adjustment simple
- Banner attaches magnetically so it's easy to swap out
- AC adapter and power cord included
- US Patent #10109222



Lumos Retractor

Item #	Description	1	2-5	6-11	12-24
261230	Kit	567.00	533.00	505.00	471.00
261236	Cartridge Kit	260.00	244.00	231.00	216.00
Kit Includes: Hardware, Installed Banner and Soft Carry Case					
Cartridge Kit Includes: Cartridge with Installed Banner and Snap Rail		USD MSRP (C)			
Product Size	Finished Graphic Size	Product Wt.	Media		
37.5"W x 31"-96"H x 9.5"D	33.5"W x 26"-90"H	22.5 lbs.	Titan™ No-Curl Opaque Fabric		



Graphic roller cartridge slides in and out of the end of the base so it can be swapped easily.



Cam lock secures the pole to the base.

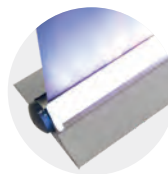

Bottom light bar is built into the base.



Top rail light simply slides onto the snap rail and is secured with thumbscrews.

Setup fee: \$20.00(G); no setup fee on orders placed via our website; see page 224 for details.
View current graphic templates, assembly videos and instructions on our website.
See pages 224-226 for additional information that may apply to your order.

AFTER FINAL PROOF APPROVAL
PRODUCTION LEAD TIME IS
2 DAYS



16"

60"

33.5"

MAGNALINK RETRACTOR

This retractor features magnetic end caps so you can link several banners and create an extra-wide display.

- Artwork is dye sublimated on Titan™ no-curl fabric
- Footless base creates a discreet appearance
- When connected, there will be a 1" gap between banners
- Available in three widths



MagnaLink Retractor

Item #	Description	1	2-5	6-11	12-24
261205	16" Kit	255.00	240.00	227.00	212.00
261210	33.5" Kit	369.00	347.00	328.00	306.00
261215	60" Kit	558.00	525.00	497.00	463.00

Kit Includes: Hardware, Installed Banner and Soft Carry Case USD MSRP (C)

Description	Product Size	Finished Graphic Size	Product Wt.	Media
16"	17.25"W x 84"-91.75"H x 8.5"D	15.75"W x 82.25"-90"H	7.25 lbs.	Titan™ No-Curl Fabric
33.5"	34.75"W x 31.75"-91.75"H x 8.5"D	33.375"W x 29.875"-90"H	13 lbs.	Titan™ No-Curl Fabric
60"	61.25"W x 31.75"-91.75"H x 8.5"D	59"W x 29.875"-90"H	21.75 lbs.	Titan™ No-Curl Fabric



MagnaLink Tabletop Retractor

We also offer a smaller MagnaLink retractor designed for tabletop use.

Item #261195
See Page 45



Magnetic end caps on base and top rail keep multiple units aligned for a professional appearance.



Flip-lever telescoping pole makes setup and adjustment simple.



Hook-and-loop fasteners make banners easy to swap out.

AFTER FINAL PROOF APPROVAL
PRODUCTION LEAD TIME IS
4 DAYS

Setup fee: \$20.00(G); no setup fee on orders placed via our website; see page 224 for details.
View current graphic templates, assembly videos and instructions on our website.
See pages 224-226 for additional information that may apply to your order.

Suggested Uses:

- Fairs
- Parks
- Golf Courses
- Parking Lots

OUTDOOR RETRACTOR

Hidden behind this retractor's banner is a heavy-duty ballast that can be filled with water or sand to keep it stable.

- Three-section telescoping pole adjusts to four heights
- Ballast base holds up to three gallons of water
- Artwork is printed on Titan™ 13 oz. scrim vinyl
- Suitable for low wind conditions (max 15 mph)
- Banners used outdoors have a 90-day warranty; banners used indoors have a 1-year warranty



Outdoor Retractor

Item #	Description	1	2-5	6-11	12-24
263015	Kit	354.00	336.00	317.00	306.00

Kit Includes: Hardware, Installed Banner and 2 Soft Carry Cases USD MSRP (C)

Product Size	Finished Graphic Size	Product Wt.	Media
32.5"W x 55"-80"H x 18.5"D	31.5"W x 53.75"-79.5"H	9 lbs.	Titan™ 13 oz. Scrim Vinyl



Wheeled base for easy transport.



Fill the base with sand or water for stability, then seal with the twist-in pole.

Suggested Uses:

- Sidewalk Sales
- Outdoor Events
- Terraces
- Bar Promotions

OUTDOOR TREK LITE RETRACTOR

This retractor's large removable feet keep it stable in the wind, making it perfect for temporary outdoor use.

- Shock cord pole for easy assembly
- Artwork is printed on Titan™ 13 oz. scrim vinyl
- Retractor includes two single-sided banners
- Suitable for low wind conditions (max 15 mph)
- Banners used outdoors have a 90-day warranty; banners used indoors have a 1-year warranty



Outdoor Trek Lite Retractor

Item #	Description	1	2-5	6-11	12-24
263040	Kit	558.00	553.00	505.00	501.00

Kit Includes: Hardware, 4 Stakes, 2 Installed Banners and Soft Carry Case USD MSRP (C)

Product Size	Finished Graphic Size	Product Wt.	Media
35.75"W x 82.25"H x 32.25"D	33.25"W x 77.25"H	22.75 lbs.	Titan™ 13 oz. Scrim Vinyl

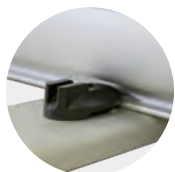

Removable feet attach securely to the base for a stable footprint.



Heavy-duty base with black ends.

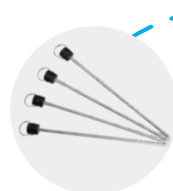

Includes four stakes to secure feet to the ground.

Setup fee: \$20.00(G); no setup fee on orders placed via our website; see page 224 for details. View current graphic templates, assembly videos and instructions on our website. See pages 224-226 for additional information that may apply to your order.

AFTER FINAL PROOF APPROVAL
PRODUCTION LEAD TIME IS
2DAYS



ELEMENT RETRACTOR

Hidden between this retractor's banners is a sturdy ballast that utilizes water or sand to keep the display stable for outdoor use.

- Artwork is printed on Titan™ 13 oz. scrim vinyl
- Retractor includes two single-sided banners
- Ballast holds up to 2.6 gallons of water
- Suitable for low wind conditions (max 15 mph)
- Banners used outdoors have a 90-day warranty; banners used indoors have a 1-year warranty



Element Retractor

Item #	Description	1	2-5	6-11	12-24
261270	Kit	475.00	447.00	423.00	394.00

Kit Includes: Hardware, 2 Installed Banners, 4 Stakes and Soft Carry Case USD MSRP (C)

Product Size	Finished Graphic Size	Product Wt.	Media
34.5"W x 38.75"-81.5"H x 20.5"D	33.25"W x 37"-80.25"H	22.5 lbs.	Titan™ 13 oz. Scrim Vinyl



Removable ballast can be filled with water or sand to keep display stable outdoors.



Pull out feet for added stability in outdoor conditions.



Includes four stakes to secure feet to the ground.

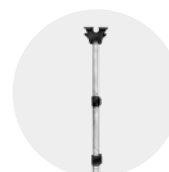

Three-section flip lever telescoping pole makes setup and adjustment simple.

AFTER FINAL PROOF APPROVAL
PRODUCTION LEAD TIME IS
2 DAYS

Setup fee: \$20.00(G); no setup fee on orders placed via our website; see page 224 for details.
View current graphic templates, assembly videos and instructions on our website.
See pages 224-226 for additional information that may apply to your order.

Suggested Uses:
 Golf Tournaments
 Soccer Games
 Flea Markets
 Restaurants



A-FRAME RETRACTOR

Suitable for indoor or outdoor use, this retractor is constructed like an A-frame for a unique landscape-style display.

- Banner available in Titan™ 13 oz. scrim vinyl or Titan™ no-curl opaque fabric
- The wide stance of the two horizontal banners clipped onto the two center poles creates an A-frame shape
- Compact, portable, and easy to assemble
- 13 oz. Vinyl banners are suitable for outdoor use; no-curl opaque banners are best for indoor use
- Banners used outdoors have a 90-day warranty; banners used indoors have a 1-year warranty



A-Frame Retractor

Item #	Description	1	2-5	6-11	12-24
261280	4' 13 oz. Scrim Vinyl Kit	580.00	545.00	516.00	481.00
261281	4' No-Curl Opaque Fabric Kit	580.00	545.00	516.00	481.00
261285	5' 13 oz. Scrim Vinyl Kit	640.00	602.00	570.00	531.00
261286	5' No-Curl Opaque Fabric Kit	640.00	602.00	570.00	531.00

Kit Includes: Hardware, 2 Installed Banners and Soft Carry Case USD MSRP (C)

Description	Product Size	Finished Graphic Size	Product Wt.
4'	50"W x 43.5"H x 29.5"D	47.5"W x 40"H	31 lbs.
5'	61.75"W x 43.5"H x 29.5"D	59.25"W x 40"H	34.5 lbs.



Two center poles and retractor bases attach to heavy duty feet to create a wide, stable footprint.



Retractor base secures to feet with the twist of a knob.



Banner rail easily attaches to the top of the pole for quick setup.

Setup fee: \$20.00(G); no setup fee on orders placed via our website; see page 224 for details.
 View current graphic templates, assembly videos and instructions on our website.
 See pages 224-226 for additional information that may apply to your order.

AFTER FINAL PROOF APPROVAL
 PRODUCTION LEAD TIME IS
2DAYS

Suggested Uses:
Trade Shows
Press Conferences
Meetings
Sports Arenas



8'



6'



5'



JUMBO WIDE RETRACTOR

Create an impressive backdrop with this ultra-wide retractable banner.

- High-tension base springs keep the banner taut
- Double-footed design for stability
- Banner available in Titan™ no-curl fabric or Titan™ 13 oz. smooth scrim vinyl
- Available in three widths



Jumbo Wide Retractor

Item #	Description	1	2-5	6-11	12-24
262138	5' No-Curl Fabric Kit	570.00	554.00	530.00	509.00
261080	5' 13 oz. Smooth Scrim Vinyl Kit	570.00	554.00	530.00	509.00
262139	6' No-Curl Fabric Kit	686.00	661.00	636.00	611.00
261082	6' 13 oz. Smooth Scrim Vinyl Kit	686.00	661.00	636.00	611.00
262140	8' No-Curl Fabric Kit	802.00	774.00	747.00	719.00
261018	8' 13 oz. Smooth Scrim Vinyl Kit	802.00	774.00	747.00	719.00
Kit Includes: Hardware, Installed Banner and Soft Carry Case				USD MSRP (C)	

Description	Product Size	Finished Graphic Size	Product Wt. (Fabric / Vinyl)
5'	60.5"W x 83"H x 15.75"D	59.75"W x 78.75"H	18.85 lbs. / 20.75 lbs.
6'	72.5"W x 83"H x 15.75"D	71.75"W x 78.75"H	21.35 lbs. / 23.5 lbs.
8'	95.5"W x 83"H x 15.75"D	94.75"W x 78.75"H	26.35 lbs. / 29.5 lbs.

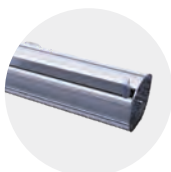

Hardware comes in silver.



Two shock cord poles support the banner.

VINYL NO-CURL FABRIC
AFTER FINAL PROOF APPROVAL
PRODUCTION LEAD TIME IS
2 OR 4 DAYS

Setup fee: \$20.00(G); no setup fee on orders placed via our website; see page 224 for details.
View current graphic templates, assembly videos and instructions on our website.
See pages 224-226 for additional information that may apply to your order.



Magnetic end caps let you align multiple units.

Flip-open base discretely hides the banner when not in use.

Lightweight aluminum base has a small footprint.

Hardware available in silver or black.

MINI RETRACTORS

These mini retractors can be used even when space is limited.

- Compact size
- Lightweight and portable
- Warranties range between six months and three years (see Retractable Banner Comparison Chart on page 27 for details)



Deluxe Mini Retractor

Item #	Description	1	2-5	6-11	12-24
262014	Kit	60.00	58.75	57.25	56.00

Kit Includes: Hardware and Installed Banner USD MSRP (C)

Mini Promo Retractor

Item #	Description	1	2-5	6-11	12-24
210240	Small Kit	46.50	44.00	43.00	41.00
210242	Large Kit	52.00	49.50	48.00	46.00

Kit Includes: Hardware and Installed Banner USD MSRP (C)

Description	Product Size	Finished Graphic Size	Product Wt.	Media
Deluxe Mini	9.375"W x 17.75"H x 4"D	8.25"W x 16.25"H	1.5 lbs.	Titan™ Polypropylene Media
Small Mini Promo	9.625"W x 13.25"H x 3"D	8.25"W x 12"H	1 lb.	Titan™ Polypropylene Media
Large Mini Promo	13.125"W x 17.875"H x 3"D	11.75"W x 16.5"H	1 lb.	Titan™ Polypropylene Media

Economy Tabletop Retractor

Item #	Description	1	2-5	6-11	12-24
261130	Tabletop No-Curl Hybrid Media Kit	173.00	161.00	150.00	138.00
262160	Tabletop No-Curl Opaque Fabric Kit	173.00	161.00	150.00	138.00

Kit Includes: Hardware, Installed Banner and Soft Carry Case USD MSRP (C)

MagnaLink Tabletop Retractor

Item #	Description	1	2-5	6-11	12-24
261195	Kit	230.00	216.00	205.00	191.00

Kit Includes: Hardware, Installed Banner and Soft Carry Case USD MSRP (C)

Description	Product Size	Finished Graphic Size	Product Wt.	Media
Economy	24.75"W x 39"H x 11"D	24"W x 35.5"H	5.25 lbs.	See Kit Description
MagnaLink	17.25"W x 44"-51.75"H x 8.5"D	15.75"W x 42.25"-50"H	6.2 lbs.	Titan™ No-Curl Fabric

Setup fee: \$20.00(G); no setup fee on orders placed via our website; see page 224 for details. View current graphic templates, assembly videos and instructions on our website. See pages 224-226 for additional information that may apply to your order.

MAGNALINK
AFTER FINAL PROOF APPROVAL
PRODUCTION LEAD TIME IS
24DAYS



1. Tri-X page 51 | 2. Monopode page 54 | 3. FrameWorx page 48

BANNER DISPLAYS

When choosing a banner display **have you considered...**

- **LOCATION** - Where will your product be displayed?
- **MESSAGE** - Do you want a single-sided or double-sided display?
- **TRANSPORT** - Will your display be stationary, or will it be moved from place to place?
- **LONGEVITY** - How long will your message be displayed?

FRAMEWORX BANNER DISPLAY

AN EYE-CATCHING FRAME THAT REALLY WORX.



FrameWorx Stack can also be used as an apparel rack if the bottom banner is removed. Bar supports up to 10 lbs.



Tension springs keep the banner centered and taut.



Each tension spring features a double-sided hook so you can hang one banner or two.



Select frames available in black or silver.



Fold-out feet for a small, stable footprint.

BANNER MEDIA

TITAN™ 13 OZ. SMOOTH SCRIM VINYL



This smooth vinyl material is ideal for high-quality graphics and indoor use.

TITAN™ NO-CURL OPAQUE FABRIC



High-quality fabric that prevents curling. Silver backing makes it opaque.

400 DENIER POLYESTER



The same durable material we use for our tent canopies.



FrameWorx Tabletop Banner Display

We also offer a smaller FrameWorx display designed for tabletop use.

Titan™ 13 oz. Smooth Scrim Vinyl Single-Sided Item #263081

Titan™ 13 oz. Smooth Scrim Vinyl Double-Sided Item #263082

Titan™ No-Curl Opaque Fabric Item #263084

See Page 165

FRAMEWORX BANNER DISPLAY

These lightweight displays feature a contemporary design that brings new life to your exhibit.

- Banners attach using low-profile clear grommets
- 3' and 3.5' frames available in black or silver
- 3.5' Stack, 4.5', 4.5' Stack, 7' Barrier, 8.5' and 10.5' frames available in black only



Suggested Uses:

- Lobbies
- Entryways
- Trade Shows
- Restaurants



3' FrameWorx Banner Display

Item #	Description	1	2-5	6-11	12-24
263061	13 oz. Smooth Scrim Vinyl Single-Sided Kit	142.00	134.00	128.00	121.00
263062	13 oz. Smooth Scrim Vinyl Double-Sided Kit	170.00	160.00	153.00	144.00
263065	No-Curl Opaque Fabric Kit	182.00	172.00	164.00	154.00

Kit Includes: Silver or Black Hardware, Banner and Soft Carry Case USD MSRP (C)

Product Size	Finished Graphic Size	Product Wt.
36.75"W x 74"H x 15.5"D	23.5"W x 67"H	5.6 lbs.

3.5' FrameWorx Banner Display

Item #	Description	1	2-5	6-11	12-24
263070	13 oz. Smooth Scrim Vinyl Single-Sided Kit	159.00	150.00	144.00	136.00
263071	13 oz. Smooth Scrim Vinyl Double-Sided Kit	187.00	177.00	169.00	159.00
263074	No-Curl Opaque Fabric Kit	194.00	183.00	175.00	165.00

Kit Includes: Silver or Black Hardware, Banner and Soft Carry Case USD MSRP (C)

Product Size	Finished Graphic Size	Product Wt.
41"W x 81.75"H x 15.5"D	27.5"W x 75"H	6.2 lbs.

3.5' FrameWorx Stack Banner Display

Item #	Description	1	2-5	6-11	12-24
263300	13 oz. Smooth Scrim Vinyl Single-Sided Kit	146.00	142.00	135.00	132.00
263301	13 oz. Smooth Scrim Vinyl Double-Sided Kit	173.00	169.00	156.00	153.00
263303	No-Curl Opaque Fabric Kit	184.00	180.00	165.00	162.00

Kit Includes: Black Hardware, 2 Banners and Soft Carry Case USD MSRP (C)

Product Size	Finished Graphic Size	Product Wt.
41"W x 81.5"H x 15.5"D	27.75"W x 34.75"H	7 lbs.

4.5' FrameWorx Banner Display

Item #	Description	1	2-5	6-11	12-24
263314	13 oz. Smooth Scrim Vinyl Single-Sided Kit	174.00	167.00	162.00	156.00
263315	13 oz. Smooth Scrim Vinyl Double-Sided Kit	202.00	190.00	184.70	170.50
263317	No-Curl Opaque Fabric Kit	208.00	196.00	190.00	175.00

Kit Includes: Black Hardware, Banner and Soft Carry Case USD MSRP (C)

Product Size	Finished Graphic Size	Product Wt.
54.75"W x 90.25"H x 15.5"D	40.5"W x 81.25"H	10.5 lbs.

AFTER FINAL PROOF APPROVAL
PRODUCTION LEAD TIME IS
2 DAYS

Setup fee: \$20.00(G); no setup fee on orders placed via our website; see page 224 for details.
View current graphic templates, assembly videos and instructions on our website.
See pages 224-226 for additional information that may apply to your order.

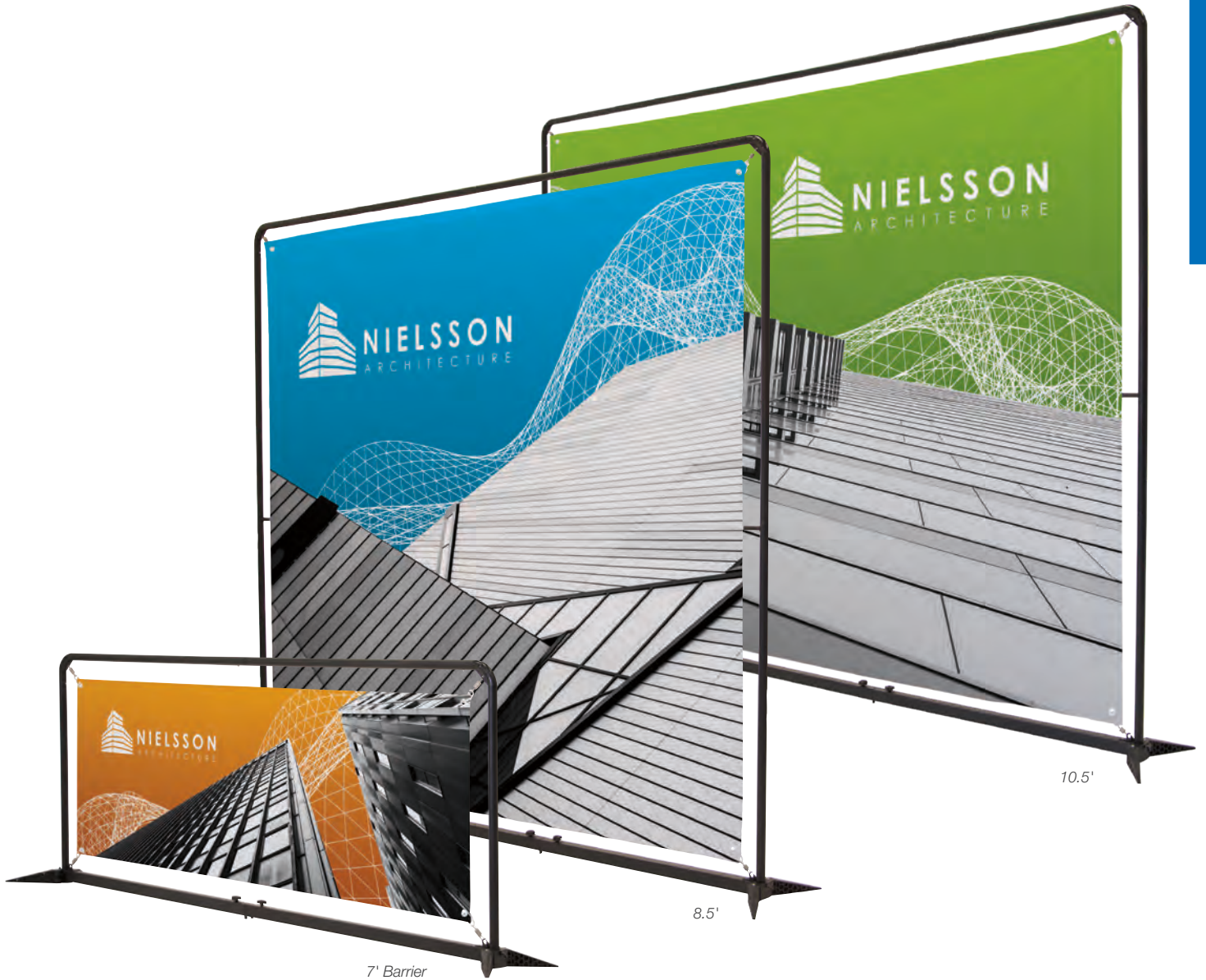

4.5' FrameWorx Stack Banner Display

Item #	Description	1	2-5	6-11	12-24
263307	13 oz. Smooth Scrim Vinyl Single-Sided Kit	163.00	155.00	150.00	142.00
263308	13 oz. Smooth Scrim Vinyl Double-Sided Kit	191.00	181.70	175.30	165.20
263310	No-Curl Opaque Fabric Kit	197.00	187.00	181.00	170.00

Kit Includes: Black Hardware, 2 Banners and Soft Carry Case
USD MSRP (C)

Product Size	Finished Graphic Size	Product Wt.
54.75"W x 72"H x 15.5"D	Top: 41.25"W x 26.25"H; Bottom: 41.25"W x 33.75"H	8.75 lbs.

8.5' FrameWorx Banner Display

Item #	Description	1	2-5	6-11	12-24
263328	400 Denier Polyester Kit	375.00	360.00	348.00	335.00

Kit Includes: Black Hardware, Banner and Soft Carry Case
USD MSRP (C)

Product Size	Finished Graphic Size	Product Wt.
101.75"W x 90.5"H x 15.5"D	87.3"W x 81.8"H	15 lbs.

7' FrameWorx Barrier Banner Display

Item #	Description	1	2-5	6-11	12-24
263321	13 oz. Smooth Scrim Vinyl Single-Sided Kit	180.00	173.00	168.00	161.00
263322	13 oz. Smooth Scrim Vinyl Double-Sided Kit	207.00	198.00	193.00	185.00
263324	No-Curl Opaque Fabric Kit	213.00	204.00	198.00	190.00

Kit Includes: Black Hardware, Banner and Soft Carry Case
USD MSRP (C)

Product Size	Finished Graphic Size	Product Wt.
86"W x 33.75"H x 15.5"D	71.5"W x 25.5"H	9 lbs.

10.5' FrameWorx Banner Display

Item #	Description	1	2-5	6-11	12-24
263331	400 Denier Polyester Kit	410.00	397.00	386.00	373.00

Kit Includes: Black Hardware, Banner and Soft Carry Case
USD MSRP (C)

Product Size	Finished Graphic Size	Product Wt.
123.25"W x 90.25"H x 15.5"D	109.3"W x 81.8"H	17 lbs.

Setup fee: \$20.00(G); no setup fee on orders placed via our website; see page 224 for details.
View current graphic templates, assembly videos and instructions on our website.
See pages 224-226 for additional information that may apply to your order.

VINYL & NO-CURL
400 DENIER
24DAYS
AFTER FINAL PROOF APPROVAL
PRODUCTION LEAD TIME IS

Suggested Uses:
Fundraisers
Sporting Events
Parties
Restaurants



8.5' Quad

4.5' Double

3.5' Double

3.5' Single

3.5' Junior



FRAMEWORX FACE CUTOUT

Let your guests become part of the show with this creative spin on our traditional FrameWorx display.

- Banners attach using low-profile clear grommets
- 3.5' frames available in black or silver
- 4.5' and 8.5' frames available in black only
- Face cutout hole locations are standard and cannot be customized



3.5' FrameWorx Face Cutout

Item #	Description	1	2-5	6-11	12-24
263054	13 oz. Smooth Scrim Vinyl Single Face Cutout Kit	159.00	150.00	144.00	136.00
263055	13 oz. Smooth Scrim Vinyl Double Face Cutout Kit	159.00	150.00	144.00	136.00
263056	13 oz. Smooth Scrim Vinyl Junior Face Cutout Kit	159.00	150.00	144.00	136.00

Kit Includes: Silver or Black Hardware, Banner and Soft Carry Case USD MSRP (C)
Product Size 41" W x 81.75" H x 15.5" D Finished Graphic Size 27.5" W x 75" H (View Online Template) Product Wt. 6.2 lbs.

4.5' FrameWorx Face Cutout

Item #	Description	1	2-5	6-11	12-24
263057	13 oz. Smooth Scrim Vinyl Double Face Cutout Kit	174.00	167.00	162.00	156.00

Kit Includes: Black Hardware, Banner and Soft Carry Case USD MSRP (C)
Product Size 54.75" W x 90.25" H x 15.5" D Finished Graphic Size 40.5" W x 81.25" H (View Online Template) Product Wt. 10.5 lbs.

8.5' FrameWorx Face Cutout

Item #	Description	1	2-5	6-11	12-24
263334	400 Denier Polyester Quad Face Cutout Kit	390.00	374.00	358.00	342.00

Kit Includes: Black Hardware, Banner and Soft Carry Case USD MSRP (C)
Product Size 101.75" W x 90.5" H x 15.5" D Finished Graphic Size 87.3" W x 81.8" H (View Online Template) Product Wt. 15 lbs.



Face cutouts in 400 denier polyester are reinforced with black Lycra® binding, giving each cutout a black outline.



Face cutouts in vinyl do not have an outline.

VINYL 400 DENIER
AFTER FINAL PROOF APPROVAL
PRODUCTION LEAD TIME IS
2 OR 4 DAYS

Setup fee: \$20.00(G); no setup fee on orders placed via our website; see page 224 for details.
View current graphic templates, assembly videos and instructions on our website.
See pages 224-226 for additional information that may apply to your order.

X BANNER DISPLAYS

The clean X design of these displays makes them simple, durable and easy to assemble.

- Artwork is printed on Titan™ 13 oz. smooth scrim vinyl
- The X shape of the frame is designed to keep the banner taut
- Corner grommets attach to plastic hooks on display arms
- Banners are finished with brass grommets by default; can be customized with nickel or clear plastic grommets by request
- Warranty details available online



Taurus Banner Display

Item #	Description	1	2-5	6-11	12-24
210124	Kit	182.00	176.00	170.00	164.00

Kit Includes: Hardware, Banner and Soft Carry Case USD MSRP (C)

Description	Product Size	Finished Graphic Size	Product Wt.	Media
	40"W x 75"H x 14"D	40"W x 75"H	5.25 lbs.	Titan™ 13 oz. Smooth Scrim Vinyl

Euro-X Banner Display

Item #	Description	1	2-5	6-11	12-24
263123	23.5" x 70" Kit	160.00	155.00	150.00	145.00
263120	31.5" x 70" Kit	200.00	190.00	180.00	170.00
263126	31.5" x 79" Kit	210.00	205.00	195.00	190.00

Kit Includes: Hardware, Banner and Drawstring Case USD MSRP (C)

Description	Product Size	Finished Graphic Size	Product Wt.	Media
23.5" x 70"	23.5"W x 70"H x 23"D	23.5"W x 70"H	2.75 lbs.	Titan™ 13 oz. Smooth Scrim Vinyl
31.5" x 70"	31.5"W x 70"H x 20.5"D	31.5"W x 70"H	3.25 lbs.	Titan™ 13 oz. Smooth Scrim Vinyl
31.5" x 79"	31.5"W x 79"H x 20.5"D	31.5"W x 79"H	3.5 lbs.	Titan™ 13 oz. Smooth Scrim Vinyl

Tri-X Banner Display

Item #	Description	1	2-5	6-11	12-24
263109	23.5" x 60" Kit	93.00	90.00	88.00	83.00
263106	23.5" x 70" Kit	103.00	100.00	98.00	96.00
263103	31.5" x 70" Kit	127.00	122.00	117.00	107.00
263112	31.5" x 79" Kit	146.00	141.00	136.00	127.00
263100	33.5" x 80" Kit	149.00	144.00	139.00	135.00

Kit Includes: Hardware, Banner and Drawstring Case USD MSRP (C)

Description	Product Size	Finished Graphic Size	Product Wt.	Media
23.5" x 60"	23.5"W x 60"H x 32.5"D	23.5"W x 60"H	2 lbs.	Titan™ 13 oz. Smooth Scrim Vinyl
23.5" x 70"	23.5"W x 70"H x 33.5"D	23.5"W x 70"H	2.25 lbs.	Titan™ 13 oz. Smooth Scrim Vinyl
31.5" x 70"	31.5"W x 70"H x 31.5"D	31.5"W x 70"H	2.25 lbs.	Titan™ 13 oz. Smooth Scrim Vinyl
31.5" x 79"	31.5"W x 79"H x 32.5"D	31.5"W x 79"H	3 lbs.	Titan™ 13 oz. Smooth Scrim Vinyl
33.5" x 80"	33.5"W x 80"H x 32.5"D	33.5"W x 79"H	3.25 lbs.	Titan™ 13 oz. Smooth Scrim Vinyl



Lightweight plastic hub offers push-button arm adjustment. Aluminum hub extends into the strong support leg. Back leg attaches to the aluminum hub to stabilize the display.

MINI X BANNER DISPLAY

This lightweight, portable display fits into small areas, making it perfect for tables and countertops.

Item #210032
See Page 165



Mini X Banner Display on a 6' Standard throw (sold separately; see pages 10-11)

POWER GRIP SIGN

The Power Grip is a window display that really stands out!

- Artwork is printed on Titan™ 13 oz. scrim vinyl
- Tool-free assembly
- Banner features clear plastic grommets
- Product not recommended for use in winds above 20mph
- Banners used outdoors have a 90-day warranty; banners used indoors have a 1-year warranty



Power Grip Sign

Item #	Description	1	2-5	6-11	12-24
263280	Kit	52.00	51.00	49.00	48.00

Kit Includes: Hardware, Banner and Carry Pouch USD MSRP (C)

Description	Product Size	Finished Graphic Size	Product Wt.	Media
	19.75"W x 47.25"H x 8.625"D	View Online Template	1.4 lbs.	Titan™ 13 oz. Scrim Vinyl



The suction cups cling to any smooth glass surface.



Setup fee: \$20.00(G); no setup fee on orders placed via our website; see page 224 for details. View current graphic templates, assembly videos and instructions on our website. See pages 224-226 for additional information that may apply to your order.

AFTER FINAL PROOF APPROVAL
PRODUCTION LEAD TIME IS
2 DAYS



Everyday banner display with silver hardware



Everyday Heavy-Duty banner display



Everyday Snap Rail banner display with two banners



EVERYDAY BANNER DISPLAY

This display features a durable steel frame with a long-lasting, powder-coated finish.

- The Everyday Banner Display features pole pockets and dowels to hold the banner in place
- The Everyday Heavy-Duty Banner Display has all the same features as the Everyday Banner Display, but reinforced with a stronger, thicker frame and wider base
- The Everyday Snap Rail Banner Display replaces the dowel and pole pockets with snap rails for a clean finish



Everyday Banner Display

Item #	Description	1	2-5	6-11	12-24
210265	Everyday Kit	185.00	180.00	175.00	170.00
210226	Everyday Heavy-Duty Kit	219.00	216.00	212.00	207.00
190161	72"H x 24"W Banner Only*	75.00	73.00	71.00	70.00
190252	72"H x 36"W Banner Only*	94.00	92.00	90.00	89.00

Kit Includes: Hardware, 1 Banner (24"W x 72"H) and 2 Dowels (24") USD MSRP (C)
 *Dowels not included in banner only orders

Description	Product Size	Finished Graphic Size	Product Wt.	Media
Everyday	24"W x 48"-92"H x 13"D	12"-36"W x 12"-91"H	11 lbs.	Titan™ 11 mil Polyester
Heavy-Duty	24"W x 55"-105"H x 14"D	12"-36"W x 12"-104"H	13.5 lbs.	Titan™ 11 mil Polyester

Everyday Snap Rail Banner Display

Item #	Description	1	2-5	6-11	12-24
264030	24" Kit	205.00	200.00	190.00	185.00
264032	30" Kit	215.00	210.00	200.00	195.00
190310	24" Banner Only	75.00	73.00	71.00	70.00
190311	30" Banner Only	84.00	82.00	80.00	79.00

24" Kit Includes: Hardware and 1 Banner (24"W x 70.5"H) USD MSRP (C)
 30" Kit Includes: Hardware and 1 Banner (30"W x 70.5"H)
 Hardware includes 4 snap rails for single- or double-sided use

Description	Product Size	Finished Graphic Size	Product Wt.	Media
24"	24"W x 48"-92"H x 13.25"D	24"W x 12"-92"H	13 lbs.	Titan™ 11 mil Polyester
30"	30"W x 48"-92"H x 13.25"D	30"W x 12"-92"H	14 lbs.	Titan™ 11 mil Polyester

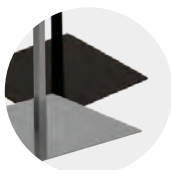

Hardware available in silver or black (Heavy-Duty and Snap Rail hardware only available in black).



Telescoping pole with thumbscrew lets you adjust the hardware for custom banner sizes (call for quote; restrictions may apply).



Each display can hold one or two banners.

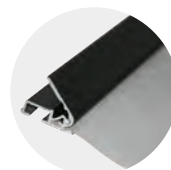

Snap Rail kit offers easy banner installation: just slide the banner into the snap rail and clamp shut.

AFTER FINAL PROOF APPROVAL
2 DAYS
 PRODUCTION LEAD TIME IS

Setup fee: \$20.00(G); no setup fee on orders placed via our website; see page 224 for details.
 View current graphic templates, assembly videos and instructions on our website.
 See pages 224-226 for additional information that may apply to your order.

Suggested Uses:

- Corridors
- Retail Stores
- Lobbies
- Craft Stores



Frame slides together and is held in place by hex screws.



With a quick press of your thumb, the fabric's gasket edge is pushed into narrow channels built into the frame.



Includes two graphic panels for a double-sided display.

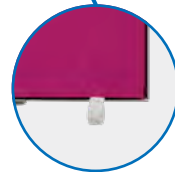

Discreet pull tab for easy graphic removal.



EVERYDAY IMPRESS DISPLAY

Silicone edge graphics (SEG) give this display an upscale look that's sure to impress.

- Heavy-duty aluminum frame
- Artwork is dye sublimated on polyester knit
- Two hex wrenches and one open-end wrench included



Everyday Impress Display

Item #	Description	1	2-5	6-11	12-24
210510	Kit	390.00	378.00	367.00	355.00
Kit Includes: Hardware and 2 Graphic Panels		USD MSRP (C)			
Product Size		Finished Graphic Size		Product Wt.	Media
23.5"W x 73.25"H x 23.5"D		View Online Template		23 lbs.	Polyester Knit



Setup fee: \$20.00(G); no setup fee on orders placed via our website; see page 224 for details. View current graphic templates, assembly videos and instructions on our website. See pages 224-226 for additional information that may apply to your order.

AFTER FINAL PROOF APPROVAL
PRODUCTION LEAD TIME IS
4 DAYS

MONOPODE DISPLAY

This hanging banner looks great in just about any environment.

- Now available as double-sided
- Aluminum pole with a steel base plate
- Push-button tubing makes assembly a snap
- Tabletop version also available (see page 165)



Monopode Display

Item #	Description	1	2-5	6-11	12-24
210255	Single-Sided Kit	146.00	137.00	130.00	121.00
210294	Double-Sided Kit	210.00	197.00	187.00	174.00
Kit Includes: Hardware, Banner, Steel Dowel and 2 Soft Carry Cases					
USD MSRP (C)					
Product Size		Finished Graphic Size		Product Wt.	
14.5"W x 61"H x 11.75"D		12"W x 49.5"H		3.9 lbs.	
				Media	
				Super Poly Knit Fabric	



Banner features a pole pocket that slides over the frame's top arm like a sleeve.

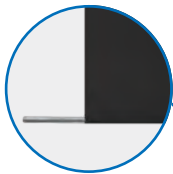

A steel dowel slides into a pole pocket at the bottom of the banner to keep it weighted down.



Single- or Double-Sided



Single-Sided
Reverse image shows through back.



Double-Sided
Image on both sides with a block-out liner in between.

CURVED CANTILEVER BANNER DISPLAY

This cantilevered frame features a stylish arc that allows a double-sided banner to hang freely.

- Durable steel hardware with powder-coated finish
- Banner hooks make graphic changes quick and easy
- Artwork is printed on Titan™ 13 oz. smooth scrim vinyl
- Banner is finished with brass grommets by default; can be customized with nickel or clear plastic grommets by request
- Hex wrench included



Curved Cantilever Banner Display

Item #	Description	1	2-5	6-11	12-24
210175	Kit	240.00	235.00	230.00	220.00
Kit Includes: Hardware and Double-Sided Banner (24"W x 74"H)					
USD MSRP (C)					
Product Size		Finished Graphic Size		Product Wt.	
30.25"W x 54.75"-96"H x 14"D		24"W x 46"-84"H		13.75 lbs.	
				Media	
				Titan™ 13 oz. Smooth Scrim Vinyl	



Corner grommets attach to hooks on the display's cantilever arm.



Telescoping pole with thumbscrew lets you adjust the hardware for custom banner sizes (call for quote; restrictions may apply).

MONOPODE CANTILEVER
AFTER FINAL PROOF APPROVAL
PRODUCTION LEAD TIME IS
4 OR 2 DAYS

Setup fee: \$20.00(G); no setup fee on orders placed via our website; see page 224 for details.
View current graphic templates, assembly videos and instructions on our website.
See pages 224-226 for additional information that may apply to your order.

Suggested Uses:

- Salons
- Retail Stores
- Car Dealerships
- Banks



SIDE SNAP BANNER DISPLAY

The Side Snap Banner Display offers the ability to customize your look with multiple banners.

- Artwork is printed on Titan™ 13 oz. smooth scrim vinyl
- Adjustable top rail is compatible with custom banner heights (call for a quote; restrictions may apply)
- Banner is double-sided
- Two hex wrenches included



Side Snap Banner Display

Item #	Description	1	2-5	6-11	12-24
263430	Kit	250.00	241.00	235.00	224.00
263433	Banner and Rails Add-On	120.00	113.00	107.00	100.00
Kit Includes: Hardware and Banner		USD MSRP (C)			
Product Size	Finished Graphic Size	Product Wt.	Media		
31.75"W x 71.25"H x 15.75"D	23.5" W x 54"H	19.2 lbs.	Titan™ 13 oz. Smooth Scrim Vinyl		

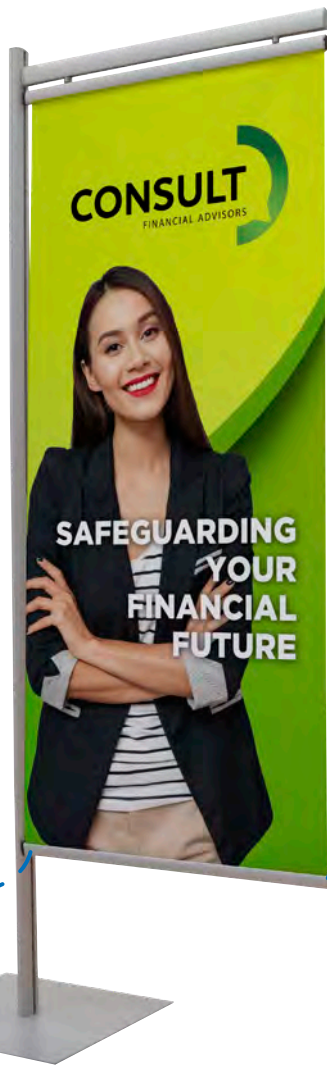

BANNER DISPLAYS



Optimize Your Footprint

Display can hold up to two banners (one banner included, additional banner and rails sold separately).

Floating bottom rail allows banner to hang freely.



Banner slides into snap rails and clamps in place; rails are capped for a clean finish.

TRILOGY BANNER DISPLAY

The Trilogy Banner Display features three times the ad space of a single banner and allows your message to be seen from any angle.

- Snap rails at the top and bottom for easy banner changes
- Artwork is printed on Titan™ 11 mil polyester
- Durable aluminum frame



Trilogy Banner Display

Item #	Description	1	2-5	6-11	12-24
263140	Kit	570.00	545.00	525.00	495.00
Kit Includes: Hardware, 3 Banners and Soft Carry Case		USD MSRP (C)			
Product Size	Finished Graphic Size	Product Wt.	Media		
37"W x 87"H x 33"D	35.75"W x 83.5"H	17 lbs.	Titan™ 11 mil Polyester		



Hinged connectors slide onto the ends of the snap rails to join the banners together.



Flip-lever telescoping poles adjust to keep the banners taut.

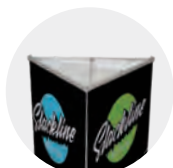

Trio of banners creates 360° graphic coverage.

Setup fee: \$20.00(G); no setup fee on orders placed via our website; see page 224 for details. View current graphic templates, assembly videos and instructions on our website. See pages 224-226 for additional information that may apply to your order.

SIDE SNAP TRILOGY AFTER FINAL PROOF APPROVAL PRODUCTION LEAD TIME IS **4 2 DAYS**



Double-banner

Single-banner



Fold-out feet for a small, stable footprint.



Banner rails are capped for a clean finish.



Banner rail attaches to the frame using thumbscrews.

BASE-X BANNER DISPLAY

This banner display makes use of the fold-out feet from our popular FrameWorx line to create a stylish look with a small footprint.

- Artwork is printed on Titan™ 11 mil polyester
- Banners are printed single-sided; kits come in single-banner and double-banner options
- Adjustable frame hardware is compatible with custom banner heights (call for quote; restrictions may apply)
- Hex wrench included



Base-X Banner Display

Item #	Description	1	2-5	6-11	12-24
263129	Single-Banner Kit	218.00	207.00	197.00	185.00
263130	Double-Banner Kit	294.00	287.00	263.00	256.00
Kit Includes: Hardware, Single-Sided Banner(s) and Soft Carry Case				USD MSRP (C)	
Product Size		Finished Graphic Size		Product Wt. (Single / Double)	
33.75"W x 89.75"H x 15.5"D		33.25"W x 78"H		11 lbs. / 12 lbs.	
				Media	
				Titan™ 11 mil Polyester	

FLEX BANNER DISPLAY

This display's versatile central post can be customized with banners and lit racks. We've created three kits to get started, but add-ons are interchangeable so you can create your own configuration.

- Artwork is dye sublimated on polyester knit
- Banners are double-sided
- Sturdy aluminum center post and banner rails
- Weighted steel base for stability
- Assembly tools included



Flex Banner Display

Item #	Description	1	2-5	6-11	12-24
263240	Single-Banner Kit	370.00	360.00	350.00	335.00
263245	Single-Banner with Lit Racks Kit	475.00	460.00	450.00	430.00
263243	Double-Banner Kit	510.00	495.00	485.00	465.00
263247	Banner and Rails Add-On	162.00	154.00	145.00	137.00
263248	Lit Racks Add-On (set of 3)	112.00	106.00	101.00	95.00
Kits Includes: Hardware and Double-Sided Banner(s)				USD MSRP (C)	

Description	Product Size	Finished Graphic Size	Product Wt.	Media
Single-Banner	27"W x 74"H x 14.75"D	23"W x 64"H	24 lbs.	Polyester Knit
Single-Banner with Lit Racks	36"W x 74"H x 14.75"D	23"W x 64"H	31 lbs.	Polyester Knit
Double-Banner	51.5"W x 74"H x 14.75"D	23"W x 64"H	26.25 lbs.	Polyester Knit



Double-banner

Single-banner with lit racks

Single-banner



Segmented pole pieces fit together and must be secured in place with the included hex wrench.



Banner rails slide into a groove on the central post and can be adjusted for custom banner sizes (call for quote; restrictions may apply).

BASE-X FLEX
AFTER FINAL PROOF APPROVAL
PRODUCTION LEAD TIME IS
24 DAYS

Setup fee: \$20.00(G); no setup fee on orders placed via our website; see page 224 for details.
View current graphic templates, assembly videos and instructions on our website.
See pages 224-226 for additional information that may apply to your order.

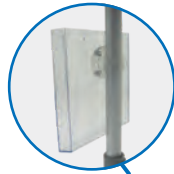

Lit rack is constructed of clear plastic, and attaches to the table's support leg with a built-in clip.



Sidekick Plus

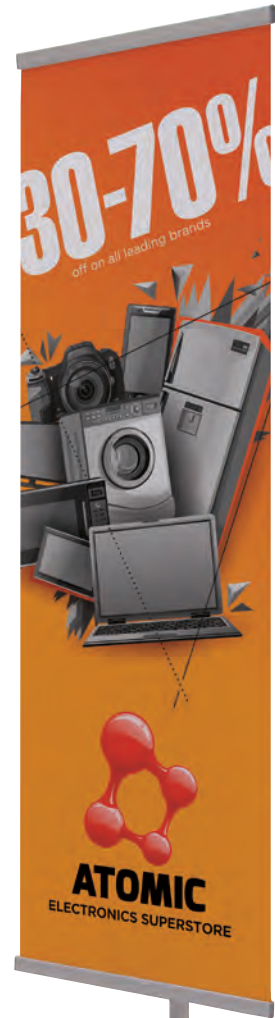

Sidekick

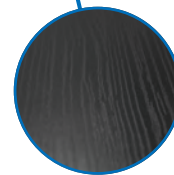

The tabletop is constructed of MDF and features a black woodgrain texture.

SIDEKICK BANNER DISPLAY

This banner display looks great and is incredibly easy to set up. The Sidekick Plus adds a table and a lit rack so you can show off products and brochures.

- Artwork is printed on Titan™ 11 mil polyester
- Telescoping pole adjusts using a thumbscrew for quick, easy setup
- Adjustable frame hardware is compatible with custom banner heights (call for quote; restrictions may apply)



Sidekick Banner Display

Item #	Description	1	2-5	6-11	12-24
263260	Kit	255.00	242.00	229.00	216.00

Kit Includes: Hardware, Banner and Soft Carry Case USD MSRP (C)

Product Size	Finished Graphic Size	Product Wt.	Media
24"W x 90"H x 14"D	23.5"W x 70.25"H	15 lbs.	Titan™ 11 mil Polyester

Sidekick Plus Banner Display

Item #	Description	1	2-5	6-11	12-24
263263	Kit	416.00	395.00	374.00	353.00

Kit Includes: Hardware, Banner and Soft Carry Case USD MSRP (C)

Product Size	Finished Graphic Size	Product Wt.	Media
24"W x 90"H x 27"D	23.5"W x 70.25"H	20 lbs.	Titan™ 11 mil Polyester



Banner rails feature swivel end caps, so banner changes are easy.

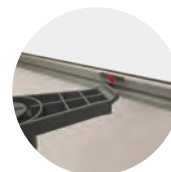

Banner hooks on the pole attach to rails on the top and bottom of the banner.



Setup fee: \$20.00(G); no setup fee on orders placed via our website; see page 224 for details. View current graphic templates, assembly videos and instructions on our website. See pages 224-226 for additional information that may apply to your order.

AFTER FINAL PROOF APPROVAL
PRODUCTION LEAD TIME IS
2DAYS



EUROFIT BANNER DISPLAY

A fabric graphic cover slides over a tubed frame, letting you create amazing backdrops or portable privacy walls.

- Multiple sizes can be arranged together for endless display possibilities
- Artwork is dye sublimated on polyester knit
- Double-sided graphic cover is viewable from both the front and back of the display
- Steel base with a black, powder-coated finish
- Not compatible with the EuroFit Connector or EuroFit Cascade Merchandiser kits



EuroFit Banner Display

Item #	Description	1	2-5	6-11	12-24
255110	2' Kit	225.00	218.00	212.00	205.00
255113	3' Kit	309.00	300.00	290.00	281.00
255116	4' Kit	413.00	404.00	391.00	382.00
255119	5' Kit	465.00	456.00	442.00	428.00

Kit Includes: Hardware, Graphic Cover and Soft Carry Case

USD MSRP (C)

Description	Product Size	Finished Graphic Size	Product Wt.	Media
2'	25.75"W x 91"H x 10"D	View Online Template	15.5 lbs.	Polyester Knit
3'	37.75"W x 91"H x 10"D	View Online Template	20.5 lbs.	Polyester Knit
4'	49"W x 91"H x 10"D	View Online Template	25.5 lbs.	Polyester Knit
5'	61"W x 91"H x 10"D	View Online Template	31.5 lbs.	Polyester Knit



Graphic cover slides easily over the frame for quick setup.

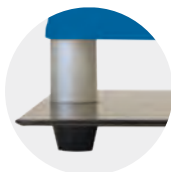

Plastic feet elevate the base and keep the display stable.

AFTER FINAL PROOF APPROVAL
PRODUCTION LEAD TIME IS
4 DAYS

Setup fee: \$20.00(G); no setup fee on orders placed via our website; see page 224 for details.
View current graphic templates, assembly videos and instructions on our website.
See pages 224-226 for additional information that may apply to your order.

EUROFIT PRO HANGING BANNER

This hanging banner offers convenient overhead message space in dimensions ideal for retail environments.

- Available in two styles and two sizes
- Lightweight aluminum frame
- Artwork is dye sublimated on polyester knit
- Zippered graphic cover is taut and wrinkle-free when installed
- Hanging cables not included (most convention centers will require you to use their designated hanging hardware)



EuroFit Pro Hanging Banner

Item #	Description	1	2-5	6-11	12-24
210282	4' x 12" Round Double-Sided Kit	622.00	602.00	587.00	567.00
210283	4' x 12" Round Bottom Panel Kit	672.00	652.00	637.00	612.00
210287	6' x 20" Round Double-Sided Kit	746.00	725.00	705.00	679.00
210288	6' x 20" Round Bottom Panel Kit	801.00	775.00	760.00	729.00

Kit Includes: Frame, Graphic Cover and Soft Carry Case USD MSRP (C)

Description	Product Size	Finished Graphic Area	Product Wt. (Double-Sided / Bottom Panel)	Media
4'	12.5"H x 48"D	View Online Template	10.5 lbs. / 11 lbs.	Polyester Knit
6'	20.25"H x 72"D	View Online Template	18.5 lbs. / 19.75 lbs.	Polyester Knit

Kit Options



Double-Sided Kit

Your artwork is printed on both the inside and the outside of the graphic cover.



Bottom Panel Kit

Your artwork is printed on the outside of the graphic cover, and the bottom is sealed off with an additional printed panel so the inside remains hidden.



EUROFIT HANGING BANNER

Grab attention from a distance with this three-dimensional hanging banner.

- Available in three shapes and a variety of sizes
- Lightweight aluminum frame
- Artwork is dye sublimated on polyester knit
- Zippered graphic cover is taut and wrinkle-free when installed
- Hanging cables not included (most convention centers will require you to use their designated hanging hardware)



EuroFit Hanging Banner

Item #	Description	1	2-5	6-11	12-24
210150	6' x 36" Round Single-Sided Kit	1030.00	1000.00	975.00	945.00
210154	8' x 42" Round Single-Sided Kit	1370.00	1340.00	1315.00	1285.00
210158	10' x 48" Round Single-Sided Kit	1715.00	1685.00	1660.00	1630.00
210162	12' x 48" Round Single-Sided Kit	1975.00	1945.00	1920.00	1890.00
210227	8' x 42" Square Single-Sided Kit	1460.00	1430.00	1405.00	1375.00
210229	8' x 42" Triangle Single-Sided Kit	1200.00	1170.00	1145.00	1115.00

Kit Includes: Frame, Graphic Cover and Soft Carry Case USD MSRP (C)

Description	Product Size	Finished Graphic Area	Product Wt.	Media
6' Round	36"H x 72"D	View Online Template	13.25 lbs.	Polyester Knit
8' Round	42.13"H x 96"D	View Online Template	17.5 lbs.	Polyester Knit
10' Round	48"H x 120"D	View Online Template	25.75 lbs.	Polyester Knit
12' Round	48"H x 144"D	View Online Template	32.5 lbs.	Polyester Knit
8' Square	96"W x 42"H x 96"D	View Online Template	20 lbs.	Polyester Knit
8' Triangle	96"W x 42"H x 96"D	View Online Template	17 lbs.	Polyester Knit



Setup fee: \$20.00(G); no setup fee on orders placed via our website; see page 224 for details. View current graphic templates, assembly videos and instructions on our website. See pages 224-226 for additional information that may apply to your order.

AFTER FINAL PROOF APPROVAL
PRODUCTION LEAD TIME IS
4 DAYS

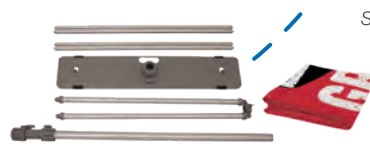

Shown with an expansion kit

Increase your ad space by adding an expansion kit.

PERFORMER BANNER DISPLAY

This heavy-duty display provides a flexible solution for outdoor advertising at festivals and events.

- Banner available in premium woven polyester or Titan™ 18 oz. opaque scrim vinyl
- Vinyl banners can be printed single- or double-sided; polyester banners available single-sided only
- Large feet and included stakes keep it stable, even on windy days
- Adjustable frame hardware is compatible with custom banner heights (call for quote; restrictions may apply)
- Banners used outdoors have a 90-day warranty; banners used indoors have a 1-year warranty



Performer Banner Display

Item #	Description	1	2-5	6-11	12-24
263287	Premium Woven Polyester Single-Sided Kit	675.00	655.00	640.00	615.00
263290	18 oz. Opaque Scrim Vinyl Single-Sided Kit	675.00	655.00	640.00	615.00
263291	18 oz. Opaque Scrim Vinyl Double-Sided Kit	730.00	710.00	695.00	665.00

Kit Includes: Hardware, Banner, 4 Stakes and Soft Carry Case with Wheels USD MSRP (C)

Product Size	Finished Graphic Size	Product Wt. (Polyester / Vinyl)
49.75"W x 91"H x 39.5"D	39.5"W x 82.25"H	48.75 lbs. / 50.25 lbs.

Performer Expansion Kit

Item #	Description	1	2-5	6-11	12-24
263289	Premium Woven Polyester Single-Sided Expansion Kit	520.00	505.00	495.00	475.00
263295	18 oz. Opaque Scrim Vinyl Single-Sided Expansion Kit	520.00	505.00	495.00	475.00
263296	18 oz. Opaque Scrim Vinyl Double-Sided Expansion Kit	570.00	555.00	540.00	520.00

Kit Includes: Hardware, Banner, 4 Stakes and Soft Carry Case with Wheels USD MSRP (C)

Product Size	Finished Graphic Size	Product Wt. (Polyester / Vinyl)
47"W x 91"H x 39.5"D	39.5"W x 82.25"H	35.25 lbs. / 36.8 lbs.



Add-On



Ballast (sold separately) keeps the feet weighted down.

Square Plastic Ballast

Item #	Description	Product Wt.	1	2-5	6-11	12-24
263298	Ballast (set of 2)	37.4 lbs w/water	57.20	53.80	50.90	47.50

USD MSRP (C)



Includes four heavy-duty black stakes.



Banner rail slides into notches in the frame's hubs.

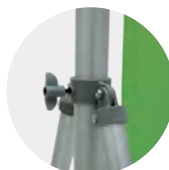

Thumbscrews on the frame make it easy to set up and adjust.



Heavy-duty steel foot features a handle so it's easy to position during setup.

VINYL OR POLYESTER
24 DAYS
AFTER FINAL PROOF APPROVAL
PRODUCTION LEAD TIME IS

Setup fee: \$20.00(G); no setup fee on orders placed via our website; see page 224 for details.
View current graphic templates, assembly videos and instructions on our website.
See pages 224-226 for additional information that may apply to your order.



C-clips attach to clear grommets along the side of the banner to keep it secure.

HEADLINER BANNER DISPLAY

This enormous banner display is great for use in parking lots or at outdoor events.

- Banner available in premium woven polyester or Titan™ 18 oz. opaque scrim vinyl
- Vinyl banners can be printed single- or double-sided; polyester banners available single-sided only
- Includes four heavy-duty black stakes
- Adjustable frame hardware is compatible with custom banner heights and widths (call for quote; restrictions may apply)
- Banners used outdoors have a 90-day warranty; banners used indoors have a 1-year warranty



Headliner Banner Display

Item #	Description	1	2-5	6-11	12-24
263400	Premium Woven Polyester Single-Sided Kit	1250.00	1215.00	1190.00	1140.00
263401	18 oz. Opaque Scrim Vinyl Single-Sided Kit	1250.00	1215.00	1190.00	1140.00
263402	18 oz. Opaque Scrim Vinyl Double-Sided Kit	1350.00	1310.00	1285.00	1230.00

Kit Includes: Hardware, Banner, 4 Stakes and Soft Carry Case with Wheels USD MSRP (C)

Product Size 129.75"W x 85.25"H x 39.5"D **Finished Graphic Size** 119"W x 76.5"H **Product Wt. (Polyester / Vinyl)** 56 lbs. / 60 lbs.



Heavy-duty steel foot features a handle so it's easy to position during setup.



Thumbscrews on the frame make it easy to set up and adjust.



Banner rail slides into notches in the frame's hubs.



Ballast keeps the feet weighted down (sold separately; see page 60).

Setup fee: \$20.00(G); no setup fee on orders placed via our website; see page 224 for details. View current graphic templates, assembly videos and instructions on our website. See pages 224-226 for additional information that may apply to your order.

VINYL POLYESTER
24 DAYS
AFTER FINAL PROOF APPROVAL PRODUCTION LEAD TIME IS



Add-On

Ballast (sold separately) keeps the feet weighted down.

Square Plastic Ballast

Item #	Description	Product Wt.	1	2-5	6-11	12-24
263298	Ballast (set of 2)	37.4 lbs w/water	57.20	53.80	50.90	47.50

USD MSRP (C)



OUTDOOR FACE CUTOUT

Go viral. The Performer and Headliner Face Cutout banner displays let your guests take their event photoshoots to the next level.

- Artwork is printed on Titan™ 18 oz. opaque scrim vinyl
- Banners are printed single-sided
- Large feet and included stakes keep it stable, even on windy days
- Face cutout hole locations are standard and cannot be customized
- Banners used outdoors have a 90-day warranty; banners used indoors have a 1-year warranty



Outdoor Face Cutout

Item #	Description	1	2-5	6-11	12-24
263270	Performer Double Face Cutout Kit	675.00	655.00	640.00	615.00
263272	Headliner Quad Face Cutout Kit	1250.00	1215.00	1190.00	1140.00

Kit Includes: Hardware, Banner, 4 Stakes and Soft Carry Case with Wheels USD MSRP (C)

Description	Product Size	Finished Graphic Size	Product Wt.	Media
Performer	49.75"W x 91"H x 39.5"D	39.5"W x 82.25"H	50.25 lbs.	Titan™ 18 oz. Opaque Scrim Vinyl
Headliner	129.75"W x 85.25"H x 39.5"D	119"W x 76.5"H	60 lbs.	Titan™ 18 oz. Opaque Scrim Vinyl

OUTDOOR DUAL TRAK BANNER DISPLAY

At 7' tall, this display is hard to miss, and its heavy-duty construction makes it perfect for outdoor use.

- Artwork is printed on Titan™ 18 oz. opaque scrim vinyl
- Banner is printed double-sided
- Wide footprint for stability
- Two hex wrenches and one open-end wrench included
- Banners used outdoors have a 90-day warranty; banners used indoors have a 1-year warranty



Outdoor Dual Trak Banner Display

Item #	Description	1	2-5	6-11	12-24
210170	Kit	385.00	375.00	365.00	350.00

Kit Includes: Hardware, Double-Sided Banner and 4 Stakes USD MSRP (C)

Product Size	Finished Graphic Size	Product Wt.	Media
30.5"W x 85"H x 43.5"D	23.25"W x 79.25"H	35.25 lbs.	Titan™ 18 oz. Opaque Scrim Vinyl



Includes four stakes to secure feet to the ground.



Spring-mounted frame allows for banner movement in light wind.

AFTER FINAL PROOF APPROVAL
PRODUCTION LEAD TIME IS
2 DAYS

Setup fee: \$20.00(G); no setup fee on orders placed via our website; see page 224 for details.
View current graphic templates, assembly videos and instructions on our website.
See pages 224-226 for additional information that may apply to your order.



Double-sided graphic cover easily slides on and off.

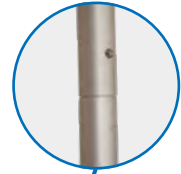

Push-button connectors make it easy to assemble.



Display foot integrates into the ballast for added stability.

Ballast can be filled with water or sand to keep it stable.

OUTDOOR BALLAST DISPLAY

This attractive outdoor display has a smaller footprint and works well in tight spaces.

- Large graphic panel provides plenty of space to display your message
- Artwork is dye sublimated on polyester knit
- Perfect for indoor or short-term outdoor use in mild conditions
- Graphic covers used outdoors have a 90-day warranty; graphic covers used indoors have a 1-year warranty



Outdoor Ballast Display

Item #	Description	1	2-5	6-11	12-24
263420	Kit	495.00	477.00	462.00	440.00
Kit Includes: Hardware, Graphic Cover and 2 Ballasts		USD MSRP (C)			

Product Size: 78"W x 59.75"H x 19.5"H
 Finished Graphic Size: 59.875"W x 55.375"H
 Product Wt.: 18.5 lbs.
 Media: Polyester Knit



Setup fee: \$20.00(G); no setup fee on orders placed via our website; see page 224 for details. View current graphic templates, assembly videos and instructions on our website. See pages 224-226 for additional information that may apply to your order.

AFTER FINAL PROOF APPROVAL
 PRODUCTION LEAD TIME IS
4 DAYS



1. Boulevard Banners page 70 | 2. Mesh Vinyl Banner page 66 | 3. Premium Sail Sign page 92

BANNERS & FLAGS

When choosing a banner or flag **have you considered...**

- **LOCATION** - Will you be using this product indoors or out?
- **USE** - Will you be hanging it on a wall or mounting it on a pole, or do you need a standalone display?
- **LONGEVITY** - How long will your banner or flag be displayed?
- **WEATHER** - Are there extreme weather conditions to consider?
- **MESSAGE** - Do you need a single-sided or double-sided banner or flag?

QUICK & EASY ONLINE BANNER ORDERING!

Visit our website for accurate quotes and hassle-free banner ordering 24/7

Under the Banners & Flags tab, click the Custom Banner option.

Accurate Quoting • Large Quantities • Additional Finishing Styles • Custom Sizes



BANNER MATERIAL COMPARISON CHART

★ = Best Sellers	TITAN™ SCRIM VINYL					FABRIC			
	10 oz.	13 oz. ★	13 oz. Smooth	18 oz. Opaque	9 oz. Mesh	Nylon	Polyester Poplin	Super Poly Knit	Satin
DURABILITY	Light Duty	Average Duty	Average Duty	Heavy Duty	Heavy Duty	Average Duty	Light Duty	Average Duty	Light Duty
WIND CONDITIONS			Not Recommended for Outdoor Use				Not Recommended for Outdoor Use		Not Recommended for Outdoor Use
INDOOR USE	Good	Better		Better	Better	Better		Better	Better
OUTDOOR USE	Good	Better	Not Recommended for Outdoor Use				Not Recommended for Outdoor Use	Better	Not Recommended for Outdoor Use

BANNER MATERIAL



SCRIM
Woven threads that provide added strength for a stronger vinyl banner.



SMOOTH
Vinyl without visible scrim texture for higher-quality images.



MESH
A woven vinyl pattern that features small holes so wind can pass through.



FABRIC
Breathable, lightweight cloth.

POPULAR FINISHING STYLES

Additional finishing styles available online.

Heat Weld

Single-sided vinyl banners only



HEM & GROMMETS



HEM, ROPE & GROMMETS

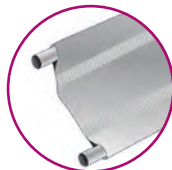

3" POLE POCKETS

Sewn

Fabric and double-sided vinyl banners

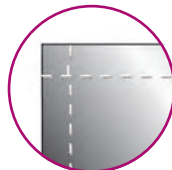

HEM ONLY



HEM & GROMMETS

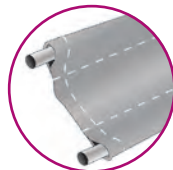

3" POLE POCKETS



3' x 8' banner with rope and grommets

10 OZ. SCRIM VINYL BANNER

This single-sided, light-duty banner is perfect for indoor or short-term outdoor use.

- Multiple finishing styles available (see page 65)
- Banners used outdoors have a 90-day warranty; banners used indoors have a 1-year warranty



10 oz. Scrim Vinyl Banner

Item #	Size	Product Wt.	1-2	3-7	8-22	23-49
304245	2' x 4'	0.5 lb.	26.64	25.04	23.28	21.60
Item #	Size	Product Wt.	1	2-4	5-14	15-33
304247	2' x 6'	1 lb.	39.96	37.56	34.92	32.40
Item #	Size	Product Wt.	1	2-3	4-9	10-22
304252	3' x 6'	1.25 lbs.	59.94	56.34	52.38	48.60
Item #	Size	Product Wt.	1-2	3-7	8-16	17-33
304253	3' x 8'	2 lbs.	75.12	69.84	64.80	58.08
304255	4' x 6'	1.5 lbs.	75.12	69.84	64.80	58.08
Item #	Size	Product Wt.	1	2-5	6-12	13-24
304256	4' x 8'	2 lbs.	100.16	93.12	86.40	77.44

USD MSRP (C)

13 OZ. SCRIM VINYL BANNER

Versatile enough for both indoor and outdoor use, this single-sided banner is a top choice when it comes to value.

- Multiple finishing styles available (see page 65)
- Banners used outdoors have a 90-day warranty; banners used indoors have a 1-year warranty



13 oz. Scrim Vinyl Banner

Item #	Size	Product Wt.	1-2	3-7	8-22	23-49
304360	2' x 4'	1 lb.	28.24	25.84	23.28	21.60
Item #	Size	Product Wt.	1	2-4	5-14	15-33
304361	2' x 6'	2 lbs.	42.36	38.76	34.92	32.40
Item #	Size	Product Wt.	1	2-3	4-9	10-22
304364	3' x 6'	2.5 lbs.	63.54	58.14	52.38	48.60
Item #	Size	Product Wt.	1-2	3-7	8-16	17-33
304365	3' x 8'	3.25 lbs.	77.52	69.84	64.80	58.08
Item #	Size	Product Wt.	1	2-5	6-13	14-26
304366	3' x 10'	4 lbs.	96.90	87.30	81.00	72.60
Item #	Size	Product Wt.	1	2-5	6-12	13-24
304367	4' x 8'	4 lbs.	103.36	93.12	86.40	77.44

USD MSRP (C)



3' x 8' banner with grommets



3' x 6' banner with grommets

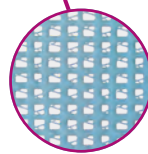

9 OZ. MESH VINYL BANNER

This single-sided banner is made of breathable 60/40 mesh vinyl that can be used on breezy days.

- Multiple sewn finishing styles available (see page 65)
- Banners used outdoors have a 90-day warranty; banners used indoors have a 1-year warranty



9 oz. Mesh Vinyl Banner

Item #	Size	Product Wt.	1	2-4	5-14	15-33
304411	2' x 6'	1.25 lbs.	48.12	44.40	40.56	37.56
Item #	Size	Product Wt.	1	2-3	4-9	10-22
304414	3' x 6'	2 lbs.	72.18	66.60	60.84	56.34
Item #	Size	Product Wt.	1-2	3-7	8-18	17-33
304415	3' x 8'	2.5 lbs.	88.80	81.12	75.12	67.92
Item #	Size	Product Wt.	1	2-5	6-13	14-26
304416	3' x 10'	3.25 lbs.	111.00	101.40	93.90	84.90
Item #	Size	Product Wt.	1	2-5	6-12	13-24
304417	4' x 8'	3 lbs.	118.40	108.16	100.16	90.56
Item #	Size	Product Wt.	1	2-4	5-9	10-19
304418	4' x 10'	4.25 lbs.	148.00	135.20	125.20	113.20

USD MSRP (C)

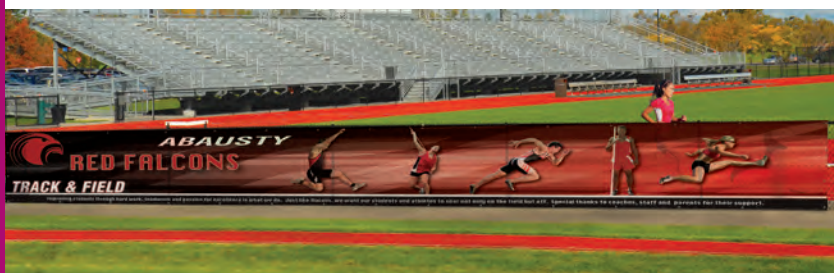

AFTER FINAL PROOF APPROVAL
PRODUCTION LEAD TIME IS
2 DAYS

Setup fee: \$20.00(G); no setup fee on orders placed via our website; see page 224 for details.
View current graphic templates, assembly videos and instructions on our website.
See pages 224-226 for additional information that may apply to your order.

13 OZ. SMOOTH SCRIM VINYL BANNER

Showcase high-quality print on the extra smooth surface of this indoor banner.

- Multiple finishing styles available (see page 65)
- Banners used indoors have a 1-year warranty

13 oz. Smooth Scrim Vinyl Banner (Single-Sided)

Item #	Size	Product Wt.	1-2	3-7	8-22	23-49
304225	2' x 4'	1 lb.	31.20	28.24	25.36	23.60
Item #	Size	Product Wt.	1	2-3	4-9	10-22
304229	3' x 6'	2 lbs.	70.20	63.54	57.06	53.10
Item #	Size	Product Wt.	1-2	3-7	8-16	17-33
304230	3' x 8'	2.5 lbs.	84.72	76.08	70.80	64.08
304261	4' x 6'	2.5 lbs.	84.72	76.08	70.80	64.08
Item #	Size	Product Wt.	1	2-5	6-12	13-24
304232	4' x 8'	3.5 lbs.	112.96	101.44	94.40	85.44
Item #	Size	Product Wt.	1	2-4	5-9	10-19
304233	4' x 10'	4.25 lbs.	141.20	126.80	118.00	106.80

USD MSRP (C)

13 oz. Smooth Scrim Vinyl Banner (Double-Sided)

Item #	Size	Product Wt.	1-2	3-7	8-22	23-49
304460	2' x 4'	1 lb.	46.64	43.36	40.00	37.52
Item #	Size	Product Wt.	1	2-4	5-16	15-33
304461	2' x 6'	1.25 lbs.	69.96	65.04	60.00	56.28
Item #	Size	Product Wt.	1	2-3	4-9	10-22
304462	3' x 6'	2 lbs.	104.94	97.56	90.00	84.42
Item #	Size	Product Wt.	1-2	3-7	8-16	17-33
304463	3' x 8'	2.5 lbs.	130.08	120.00	112.56	101.76

USD MSRP (C)

18 OZ. OPAQUE SCRIM VINYL BANNER

This banner is reinforced with scrim, making it extremely durable for outdoor use.

- Multiple finishing styles available (see page 65)
- Banners used outdoors have a 90-day warranty; banners used indoors have a 1-year warranty



18 oz. Opaque Scrim Vinyl Banner (Single-Sided)

Item #	Size	Product Wt.	1	2-4	5-14	15-33
304383	3' x 4'	2 lbs.	48.12	44.28	40.56	37.56
Item #	Size	Product Wt.	1	2-3	4-9	10-22
304384	3' x 6'	2.5 lbs.	72.18	66.42	60.84	56.34
Item #	Size	Product Wt.	1-2	3-7	8-16	17-33
304385	3' x 8'	3.25 lbs.	88.56	81.12	75.12	67.92
Item #	Size	Product Wt.	1	2-5	6-13	14-26
304386	3' x 10'	4 lbs.	110.70	101.40	93.90	84.90
Item #	Size	Product Wt.	1	2-5	6-12	13-24
304387	4' x 8'	4 lbs.	118.08	108.16	100.16	90.56
Item #	Size	Product Wt.	1	2-4	5-9	10-19
304388	4' x 10'	5 lbs.	147.60	135.20	125.20	113.20

USD MSRP (C)

18 oz. Opaque Scrim Vinyl Banner (Double-Sided)

Item #	Size	Product Wt.	1-2	3-7	8-22	23-49
304470	2' x 4'	1 lb.	68.16	63.92	59.52	56.00
Item #	Size	Product Wt.	1	2-4	5-14	15-33
304471	2' x 6'	2 lbs.	102.24	95.88	89.28	84.00
Item #	Size	Product Wt.	1	2-3	4-9	10-22
304472	3' x 6'	2.5 lbs.	153.36	143.82	133.92	126.00
Item #	Size	Product Wt.	1-2	3-7	8-16	17-33
304473	3' x 8'	3.25 lbs.	191.76	178.56	168.00	155.28
Item #	Size	Product Wt.	1	2-5	6-12	13-24
304474	4' x 8'	4 lbs.	255.68	238.08	224.00	207.04

USD MSRP (C)



4' x 10' banner with grommets



3' x 6' banner with grommets



2' x 4' banners with pole pockets

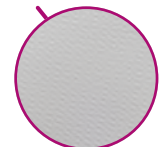

Scrim texture will be subtly visible on the backside of the banner.

Setup fee: \$20.00(G); no setup fee on orders placed via our website; see page 224 for details.
View current graphic templates, assembly videos and instructions on our website.
See pages 224-226 for additional information that may apply to your order.

AFTER FINAL PROOF APPROVAL
PRODUCTION LEAD TIME IS
2 DAYS



NEW PRODUCT

FENCE BANNER

Turn unattractive fences into full-color advertisements with this outdoor fence banner.

- Perfect for sporting events or construction sites
- Banner available in mesh fabric or mesh vinyl
- Mesh fabric can be folded for easy transportation and storage; vinyl banners must be rolled
- Banners used outdoors have a 90-day warranty; banners used indoors have a 1-year warranty
- Attach to fence using rope or zip ties (not included)



9 oz. Mesh Vinyl Fence Banner

Item #	Size	Product Wt.	1	2-5	6-11	12-24
304950	10' x 36"	1.5 lbs.	110.00	105.00	99.00	94.00
304951	15' x 36"	2.2 lbs.	164.00	156.00	148.00	139.00
304952	20' x 36"	2.75 lbs.	200.00	190.00	180.00	170.00
304953	10' x 60"	2.4 lbs.	182.00	173.00	164.00	155.00
304954	15' x 60"	3.5 lbs.	250.00	238.00	225.00	213.00
304955	20' x 60"	4.6 lbs.	333.00	316.00	300.00	283.00

USD MSRP (C)

Mesh Fabric Fence Banner

Item #	Size	Product Wt.	1	2-5	6-11	12-24
304960	10' x 36"	0.75 lb.	150.00	143.00	135.00	128.00
304961	15' x 36"	1 lb.	225.00	214.00	203.00	191.00
304962	20' x 36"	1.25 lbs.	300.00	285.00	270.00	255.00
304963	10' x 60"	1 lb.	250.00	238.00	225.00	213.00
304964	15' x 60"	1.5 lbs.	375.00	356.00	338.00	319.00
304965	20' x 60"	2 lbs.	500.00	475.00	450.00	425.00

USD MSRP (C)

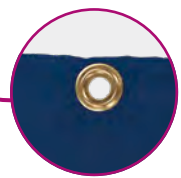

Standard grommet placement gives you plenty of anchor points.



Lightweight mesh is perfect for repeated short-term use.

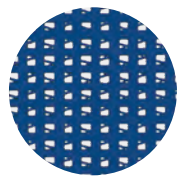

Vinyl mesh is fade resistant and durable; perfect for prolonged outdoor use.

24 DAYS
VINYL OR FABRIC
AFTER FINAL PROOF APPROVAL
PRODUCTION LEAD TIME IS

Setup fee: \$20.00(G); no setup fee on orders placed via our website; see page 224 for details.
View current graphic templates, assembly videos and instructions on our website.
See pages 224-226 for additional information that may apply to your order.

SUPER POLY KNIT FABRIC BANNER

This lightweight fabric banner allows wind to pass through, making it great for outdoor use.

- Full-color, dye-sublimated graphics
- Multiple finishing styles available (see page 65)
- Banners used outdoors have a 90-day warranty; banners used indoors have a 1-year warranty



Super Poly Knit Fabric Banner

Item #	Size	Product Wt.	1-2	3-7	8-22	23-49
304420	2' x 4'	0.21 lb.	61.52	54.88	49.20	44.24
Item #	Size	Product Wt.	1	2-4	5-14	15-33
304421	2' x 6'	0.32 lb.	92.28	82.32	73.80	66.36
Item #	Size	Product Wt.	1	2-3	4-9	10-22
304424	3' x 6'	0.48 lb.	138.42	123.48	110.70	99.54
Item #	Size	Product Wt.	1-2	3-7	8-16	17-33
304425	3' x 8'	0.65 lb.	164.64	147.60	132.72	116.88
Item #	Size	Product Wt.	1	2-5	6-12	13-24
304427	4' x 8'	0.86 lb.	219.52	196.80	176.96	155.84
Item #	Size	Product Wt.	1	2-4	5-9	10-19
304430	5' x 8'	1.08 lbs.	274.40	246.00	221.20	194.80

USD MSRP (C)

POLY POPLIN FABRIC BANNER

With high-quality dye-sublimated graphics, this banner is ideal for indoor, close-range viewing.

- Multiple finishing styles available (see page 65)
- Banners used indoors have a 1-year warranty

Poly Poplin Fabric Banner

Item #	Size	Product Wt.	1-2	3-7	8-22	23-49
305000	2' x 4'	0.25 lb.	47.44	44.08	41.60	39.84
Item #	Size	Product Wt.	1	2-5	6-17	18-39
305012	2' x 5'	0.5 lb.	59.30	55.10	52.00	49.80
Item #	Size	Product Wt.	1	2-4	5-14	15-33
305001	2' x 6'	0.5 lb.	71.16	66.12	62.40	59.76
Item #	Size	Product Wt.	1	2-3	4-11	12-26
305002	2' x 8'	0.5 lb.	94.88	88.16	83.20	79.68
305014	3' x 5'	0.5 lb.	88.95	82.65	78.00	74.70
Item #	Size	Product Wt.	1	2-3	4-9	10-22
305004	3' x 6'	1 lb.	106.74	99.18	93.60	89.64
Item #	Size	Product Wt.	1-2	3-7	8-16	17-33
305005	3' x 8'	1 lb.	132.24	124.80	119.52	111.12
Item #	Size	Product Wt.	1	2-5	6-12	13-24
305007	4' x 8'	1 lb.	176.32	166.40	159.36	148.16

USD MSRP (C)

SATIN BANNER

Satin fabric has a formal appearance and an elegant finish, making it a crowd-pleaser at indoor events.

- Full-color, dye-sublimated graphics
- Multiple finishing styles available (see page 65)
- Banners used indoors have a 1-year warranty

Satin Banner

Item #	Size	Product Wt.	1-2	3-7	8-22	23-49
304740	2' x 4'	0.2 lb.	48.72	45.04	41.84	39.36
Item #	Size	Product Wt.	1	2-3	4-9	10-22
304741	3' x 6'	0.45 lb.	109.62	101.34	94.14	88.56
Item #	Size	Product Wt.	1-2	3-7	8-16	17-33
304742	3' x 8'	0.6 lb.	135.12	125.52	118.08	109.68
304743	4' x 6'	0.6 lb.	135.12	125.52	118.08	109.68
Item #	Size	Product Wt.	1	2-5	6-12	13-24
304744	4' x 8'	0.8 lb.	180.16	167.36	157.44	146.24

USD MSRP (C)



3' x 6' banner with corner grommets



2' x 4' banner with pole pockets



3' x 8' banner with corner grommets



3' x 6' banner with pole pockets



Setup fee: \$20.00(G); no setup fee on orders placed via our website; see page 224 for details.
View current graphic templates, assembly videos and instructions on our website.
See pages 224-226 for additional information that may apply to your order.

AFTER FINAL PROOF APPROVAL
PRODUCTION LEAD TIME IS
4 DAYS



BOULEVARD BANNERS

High-quality banners lend an upscale flair to any street or parking lot.

- Finished with 3" pole pockets on top and bottom
- Bracket system sold separately (see page 71)
- Custom sizes available (call for quote; restrictions may apply)
- Banners used outdoors have a 90-day warranty; banners used indoors have a 1-year warranty



Vinyl Boulevard Banner (Double-Sided)

Item #	Description	Product Wt.	1-4	5-13	14-39	40-88
302031	18" x 36"	1.12 lbs.	38.34	35.96	33.48	31.50
Item #	Description	Product Wt.	1-3	4-9	10-29	30-66
302033	18" x 48"	1.5 lbs.	51.12	47.94	44.64	42.00
302035	24" x 36"	1.5 lbs.	51.12	47.94	44.64	42.00
Item #	Description	Product Wt.	1-2	3-7	8-22	23-49
302037	24" x 48"	2 lbs.	68.16	63.92	59.52	56.00
Item #	Description	Product Wt.	1	2-5	6-17	18-39
302039	24" x 60"	2.5 lbs.	85.20	79.90	74.40	70.00
Item #	Description	Product Wt.	1	2-4	5-14	15-33
302041	24" x 72"	3 lbs.	102.24	95.88	89.28	84.00
Item #	Description	Product Wt.	1	2-3	4-11	12-24
302043	24" x 96"	4 lbs.	136.32	127.84	119.04	112.00
Item #	Description	Product Wt.	1	2-4	5-14	15-31
302045	30" x 60"	3.12 lbs.	106.50	99.88	93.00	87.50
Item #	Description	Product Wt.	1	2-3	4-11	12-26
302047	30" x 72"	3.75 lbs.	127.80	119.85	111.60	105.00
Item #	Description	Product Wt.	1	2-3	4-10	11-22
302049	30" x 84"	4.5 lbs.	149.10	139.83	130.20	122.50

Banner only. Hardware sold separately (see page 71). USD MSRP (C)

Nylon Boulevard Banner (Single-Sided)

Item #	Description	Product Wt.	1	2-5	6-11	12-24
302130	18" x 36"	0.3 lb.	40.00	39.00	38.00	38.00
302131	18" x 48"	0.4 lb.	46.00	45.00	44.00	43.00
302132	24" x 36"	0.4 lb.	46.00	45.00	44.00	43.00
302133	24" x 48"	0.5 lb.	58.00	57.00	56.00	55.00
302134	24" x 60"	0.6 lb.	63.00	62.00	60.00	59.00
302135	24" x 72"	0.7 lb.	105.00	103.00	101.00	99.00
302136	24" x 96"	1 lb.	145.00	142.00	139.00	136.00
302137	30" x 60"	0.8 lb.	80.00	78.00	77.00	75.00
302138	30" x 72"	0.9 lb.	115.00	113.00	110.00	108.00
302139	30" x 84"	1 lb.	140.00	137.00	134.00	132.00

Banner only. Hardware sold separately (see page 71). USD MSRP (C)

Fabric Boulevard Banner (Double-Sided)

Item #	Description	Product Wt.	1	2-5	6-11	12-24
302078	18" x 36"	0.6 lb.	140.00	137.00	134.00	132.00
302079	18" x 48"	0.8 lb.	150.00	147.00	144.00	141.00
302080	24" x 36"	0.8 lb.	157.00	154.00	151.00	148.00
302081	24" x 48"	1 lb.	162.00	159.00	156.00	152.00
302082	24" x 60"	1.2 lbs.	172.00	169.00	165.00	162.00
302083	24" x 72"	1.4 lbs.	182.00	178.00	175.00	171.00
302084	24" x 96"	2 lbs.	208.00	204.00	200.00	196.00
302085	30" x 60"	1.6 lbs.	208.00	204.00	200.00	196.00
302086	30" x 72"	1.8 lbs.	224.00	220.00	215.00	211.00
302087	30" x 84"	2 lbs.	229.00	224.00	220.00	215.00

Banner only. Hardware sold separately (see page 71). USD MSRP (C)

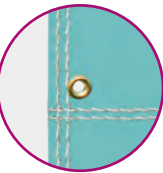
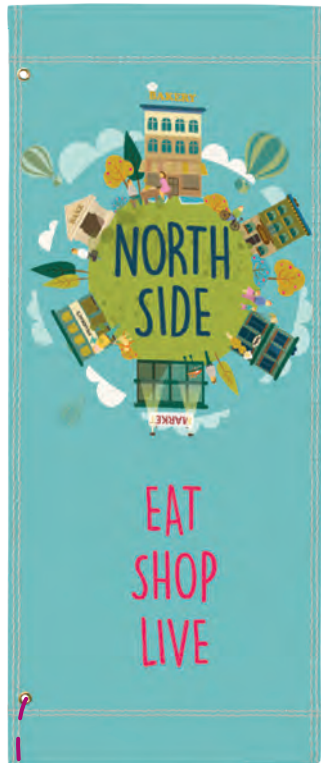

Two grommets along one edge of the banner.



Strong Titan™ 18 oz. opaque scrim vinyl.

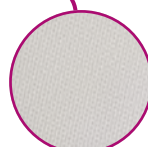

200 denier nylon woven threads hold color longer for prolonged outdoor use. Reverse image shows through the back.

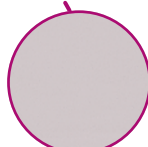

400 denier polyester is double-sided with block-out liner.



VINYL OR FABRIC & NYLON
24 DAYS
AFTER FINAL PROOF APPROVAL
PRODUCTION LEAD TIME IS

Setup fee: \$20.00(G); no setup fee on orders placed via our website; see page 224 for details.
View current graphic templates, assembly videos and instructions on our website.
See pages 224-226 for additional information that may apply to your order.

VERSATILE BRACKET SYSTEM

Designed to be adaptable, this bracket system mounts to most standard wood and steel poles.

- Rust-free cast aluminum with fiberglass arms
- Stainless steel bands hold brackets in place
- Works with square, round, and polygonal poles
- 1° incline keeps banner taut
- Accepts banners up to 24 sq. ft. in size
- Banners sold separately (see page 70)



Cast aluminum brackets



Versatile Bracket System

Item #	Description	Product Wt.	1-9	10-24	25-49	50-99
302020	18" Single	3 lbs.	91.00	86.00	75.00	70.00
302006	24" Single	3.25 lbs.	92.00	88.00	82.00	79.00
302008	30" Single	3.75 lbs.	96.00	91.00	85.00	81.00
302022	36" Single	4 lbs.	103.00	97.00	90.00	85.00
302021	18" Double	5.25 lbs.	148.00	143.00	132.00	127.00
302007	24" Double	6 lbs.	153.00	148.00	137.00	132.00
302009	30" Double	6.75 lbs.	165.00	154.00	144.00	138.00
302023	36" Double	7.5 lbs.	180.00	169.00	164.00	159.00

Hardware only. Banner sold separately (see page 70).

USD MSRP (C)

PREMIUM BRACKET SYSTEM

This bracket system is built to withstand the harshest outdoor elements. Patent# 6378820.

- Premium Single includes two Premium arms (one top, one bottom)
- Premium Double includes four Premium arms (two top, two bottom)
- Premium Single with Spring Arm includes one top Premium arm and one bottom spring arm
- Premium Double with Spring Arm includes two top Premium arms and two bottom spring arms
- Banners sold separately (see page 70)



The spring arm has a 1° incline to keep banners taut and easily snaps back into place after banner changes.

Premium Bracket System

Item #	Description	Product Wt.	1	2-5	6-11	12-24
302060	30" Single	5.25 lbs.	116.00	111.00	105.00	100.00
302061	30" Double	10 lbs.	197.00	192.00	186.00	181.00

Hardware only. Banner sold separately (see page 70).

USD MSRP (C)

Premium Bracket System with Spring Arm

Item #	Description	Product Wt.	1	2-5	6-11	12-24
302062	30" Single w/Spring Arm	6 lbs.	146.00	143.00	140.00	137.00
302063	30" Double w/Spring Arm	11.5 lbs.	249.00	244.00	238.00	233.00

Hardware only. Banner sold separately (see page 70).

USD MSRP (C)

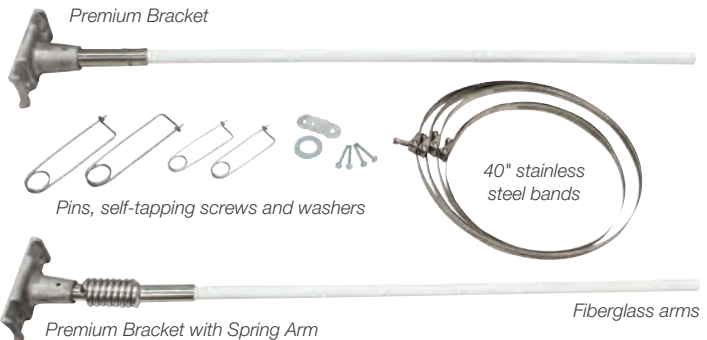

WALL-MOUNT BRACKET SYSTEM

Rust-free cast aluminum brackets let you attach a banner to any wall, whether indoors or out.

- Banners sold separately (see page 70)



Wall-Mount Bracket System

Item #	Description	Product Wt.	1	10	100	250
302200	18" Bracket System	3.5 lbs.	76.00	72.00	67.00	64.00
302201	24" Bracket System	4 lbs.	76.00	72.00	67.00	64.00
302202	30" Bracket System	6 lbs.	76.00	72.00	67.00	64.00
302203	36" Bracket System	6.5 lbs.	76.00	72.00	67.00	64.00

Hardware only; screws/bolts not included. Banner sold separately (see page 70).

USD MSRP (C)

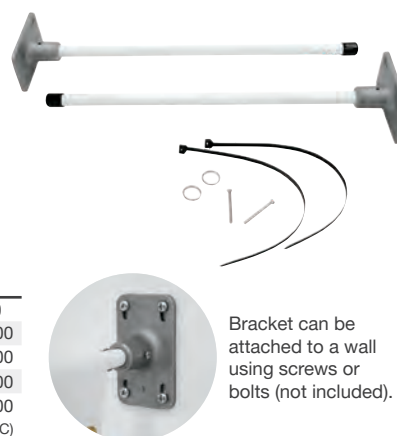

Bracket can be attached to a wall using screws or bolts (not included).



View current assembly videos and instructions on our website.
See pages 224-226 for additional information that may apply to your order.

**HARDWARE SHIPS
SAME DAY**
WHEN ORDERED BEFORE 2PM CENTRAL

**NEW
PRODUCT**

BRAIDEN HIGH SCHOOL

BOBCATS
FOOTBALL
CHEW 'EM UP, SPIT 'EM OUT!
CATS!

6' x 10'

For best results, push swedge poles into the ground and hold the top half of each side to keep it taut.

Hook-and-loop fasteners are strong enough to hold the two panels together but make the banner easy to burst through.



TEARAWAY BANNER

Create a grand entrance at sporting events with a Tearaway Banner. Burst it apart and put it back together again!

- Artwork is printed on polyester knit
- The tearaway banner is made of two panels that attach to one another using hook-and-loop fasteners
- Each panel features a 3" pole pocket along the edge; pole pockets are closed at the top to prevent the banner from sliding down the poles
- Double-needle hem along the non-pole-pocket edge
- Banners used outdoors have a 90-day warranty; banners used indoors have a 1-year warranty



Don't forget your Spirit Flag!

Show your support in the stands with your mascot on a Spirit Flag.

Single- or double-sided options available. See Page 83

Tearaway Banner

Item #	Size	Product Wt.	1	2-5	6-11	12-24
304680	6' x 10' Kit	3 lbs.	385.00	375.00	365.00	350.00
304682	8' x 12' Kit	7.5 lbs.	580.00	565.00	550.00	530.00
304684	10' x 15' Kit	6.5 lbs.	825.00	800.00	785.00	750.00

Kit Includes: Hardware and Banner

USD MSRP (C)

4 DAYS
AFTER FINAL PROOF APPROVAL
PRODUCTION LEAD TIME IS

Setup fee: \$20.00(G); no setup fee on orders placed via our website; see page 224 for details. View current graphic templates, assembly videos and instructions on our website. See pages 224-226 for additional information that may apply to your order.

QUICK & EASY ONLINE FLAG ORDERING!

Visit our website for accurate quotes and hassle-free flag ordering 24/7

Under the Banners & Flags tab, click the Custom Flag option.

Accurate Quoting • Large Quantities • Additional Finishing Styles • Custom Sizes



FLAG MATERIAL COMPARISON CHART

★ = Best Sellers	MATERIAL CONSTRUCTION	WIND CONDITIONS	BEST USE	COLOR FASTNESS	REVERSE SIDE COLOR	SHAPES
200 Denier Nylon	 Tightly woven threads provide better longevity and hold color for longer.		Recommended for Indoor and Outdoor Use	★★★★	 Reverse image will show through on back; color is vibrant on both sides.	Rectangle Burgee Pennant Guidon
Super Poly Knit ★	 Knitted fibers create a lightweight material that holds up better in windy conditions.		Recommended for Outdoor Use	★★★	 Reverse image will show through on back; color is muted on back side.	Rectangle

POPULAR FINISHING STYLES

Details and additional finishing styles available online.

Header

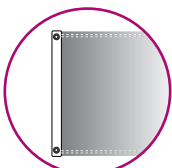

CANVAS HEADER & GROMMETS
(Standard Finishing)

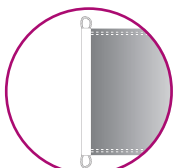

CANVAS HEADER & ROPE/THIMBLE
(Recommended for flags that are 8'x12' or larger)

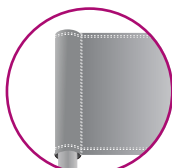

3" POLE SLEEVE VISIBLE, CLOSED AT TOP

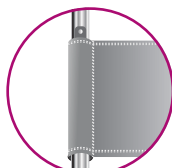

3" POLE SLEEVE VISIBLE, OPEN AT TOP, LEATHER TAB

Edges

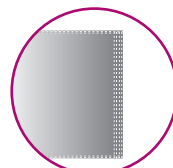

4-ROW LOCK-STITCHING

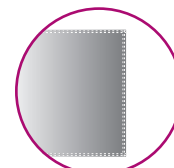

DOUBLE NEEDLE HEM

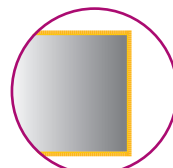

GOLD FRINGE

NYLON FLAG

Lightweight and fade resistant, our nylon flags come in a variety of shapes and sizes and are perfect for indoor and outdoor use.

- Constructed of 200 denier nylon
- Standard finishing includes canvas header and brass grommets
- Multiple finishing styles available (see page 73 for popular options)
- Four rows of lock-stitching provide extra reinforcement on the fly end of the flag
- Single-sided and double-sided options available
- Flags that are 8' x 12' and larger contain lap seams
- Custom sizes available (call for quote; restrictions may apply)
- Flags used outdoors have a 90-day warranty; flags used indoors have a 1-year warranty



Rectangle: The oldest and most common shape in advertising

Rectangle Nylon Flag (Single-Sided)

Item #	Size	Product Wt.	1	2-5	6-11	12-24
304530	8" X 12"	0.25 lb.	36.00	32.40	28.80	25.20
304531	12" X 18"	0.25 lb.	40.00	36.00	32.00	28.00
304532	16" X 24"	0.25 lb.	44.00	39.60	35.20	30.80
304533	2' X 3'	0.3 lb.	50.00	45.00	40.00	35.00
304534	2.5' X 4'	0.4 lb.	70.00	63.00	56.00	49.00
304535	3' X 5'	0.5 lb.	80.00	72.00	64.00	56.00
304536	4' X 6'	0.7 lb.	110.00	99.00	88.00	77.00
304537	5' X 8'	1 lb.	160.00	152.00	144.00	136.00
304538	6' X 10'	1.6 lbs.	230.00	218.50	207.00	195.50
304539	8' X 12'	2.9 lbs.	390.00	370.50	351.00	331.50
304540	10' X 15'	4.6 lbs.	650.00	617.50	585.00	552.50
304541	12' X 18'	6.5 lbs.	950.00	902.50	855.00	807.50
304542	15' X 25'	13.25 lbs.	1400.00	1330.00	1260.00	1190.00
304543	20' X 30'	21 lbs.	2500.00	2375.00	2250.00	2125.00
304544	20' X 38'	26.6 lbs.	3000.00	2850.00	2700.00	2550.00
304545	25' X 40'	35 lbs.	3800.00	3610.00	3420.00	3230.00
304546	30' X 50'	52.5 lbs.	5300.00	5035.00	4770.00	4505.00
304547	30' X 60'	63 lbs.	6500.00	6175.00	5850.00	5525.00

USD MSRP (C)

Rectangle Nylon Flag (Double-Sided)

Item #	Size	Product Wt.	1	2-5	6-11	12-24
304550	8" X 12"	0.75 lb.	72.00	64.80	57.60	50.40
304551	12" X 18"	0.75 lb.	80.00	72.00	64.00	56.00
304552	16" X 24"	0.75 lb.	88.00	79.20	70.40	61.60
304553	2' X 3'	0.9 lb.	100.00	90.00	80.00	70.00
304554	2.5' X 4'	1.2 lbs.	140.00	126.00	112.00	98.00
304555	3' X 5'	1.5 lbs.	160.00	144.00	128.00	112.00
304556	4' X 6'	2.1 lbs.	220.00	198.00	176.00	154.00
304557	5' X 8'	3 lbs.	320.00	304.00	288.00	272.00
304558	6' X 10'	4.8 lbs.	460.00	437.00	414.00	391.00

USD MSRP (C)

Single-Sided



Single-sided flags are printed on one side; reverse image shows through the back.

Double-Sided



Double-sided flags have the image on both sides with a block-out liner in between.

AFTER FINAL PROOF APPROVAL
PRODUCTION LEAD TIME IS
4 DAYS

Setup fee: \$20.00(G); no setup fee on orders placed via our website; see page 224 for details.
View current graphic templates, assembly videos and instructions on our website.
See pages 224-226 for additional information that may apply to your order.

Pennant Nylon Flag (Single-Sided)

Item #	Size	Product Wt.	1	2-5	6-11	12-24
304600	8" X 12"	0.25 lb.	36.00	32.40	28.80	25.20
304601	12" X 18"	0.25 lb.	40.00	36.00	32.00	28.00
304602	16" X 24"	0.25 lb.	44.00	39.60	35.20	30.80
304603	2' X 3'	0.25 lb.	50.00	45.00	40.00	35.00
304604	2.5' X 4'	0.4 lb.	70.00	63.00	56.00	49.00
304605	3' X 5'	0.5 lb.	80.00	72.00	64.00	56.00
304606	4' X 6'	0.7 lb.	110.00	99.00	88.00	77.00
304607	5' X 8'	1 lb.	160.00	152.00	144.00	136.00
304608	6' X 10'	1.6 lbs.	230.00	219.00	207.00	196.00

USD MSRP (C)

Pennant Nylon Flag (Double-Sided)

Item #	Size	Product Wt.	1	2-5	6-11	12-24
304610	8" X 12"	0.75 lb.	72.00	64.80	57.60	50.40
304611	12" X 18"	0.75 lb.	80.00	72.00	64.00	56.00
304612	16" X 24"	0.75 lb.	88.00	79.20	70.40	61.60
304613	2' X 3'	0.75 lb.	100.00	90.00	80.00	70.00
304614	2.5' X 4'	1.2 lbs.	140.00	126.00	112.00	98.00
304615	3' X 5'	1.5 lbs.	160.00	144.00	128.00	112.00
304616	4' X 6'	2.1 lbs.	220.00	198.00	176.00	154.00
304617	5' X 8'	3 lbs.	320.00	304.00	288.00	272.00
304618	6' X 10'	4.8 lbs.	460.00	437.00	414.00	391.00

USD MSRP (C)



Pennant: Most often used for identifying athletic teams

Guidon Nylon Flag (Single-Sided)

Item #	Size	Product Wt.	1	2-5	6-11	12-24
304580	8" X 12"	0.25 lb.	36.00	32.40	28.80	25.20
304581	12" X 18"	0.25 lb.	40.00	36.00	32.00	28.00
304582	16" X 24"	0.25 lb.	44.00	39.60	35.20	30.80
304583	2' X 3'	0.25 lb.	50.00	45.00	40.00	35.00
304584	2.5' X 4'	0.4 lb.	70.00	63.00	56.00	49.00
304585	3' X 5'	0.5 lb.	80.00	72.00	64.00	56.00
304586	4' X 6'	0.7 lb.	110.00	99.00	88.00	77.00
304587	5' X 8'	1 lb.	160.00	152.00	144.00	136.00
304588	6' X 10'	1.6 lbs.	230.00	219.00	207.00	196.00

USD MSRP (C)

Guidon Nylon Flag (Double-Sided)

Item #	Size	Product Wt.	1	2-5	6-11	12-24
304590	8" X 12"	0.75 lb.	72.00	64.80	57.60	50.40
304591	12" X 18"	0.75 lb.	80.00	72.00	64.00	56.00
304592	16" X 24"	0.75 lb.	88.00	79.20	70.40	61.60
304593	2' X 3'	0.75 lb.	100.00	90.00	80.00	70.00
304594	2.5' X 4'	1.2 lbs.	140.00	126.00	112.00	98.00
304595	3' X 5'	1.5 lbs.	160.00	144.00	128.00	112.00
304596	4' X 6'	2.1 lbs.	220.00	198.00	176.00	154.00
304597	5' X 8'	3 lbs.	320.00	304.00	288.00	272.00
304598	6' X 10'	4.8 lbs.	460.00	437.00	414.00	391.00

USD MSRP (C)



Guidon: Commonly used for promoting military units

Burgee Nylon Flag (Single-Sided)

Item #	Size	Product Wt.	1	2-5	6-11	12-24
304560	8" X 12"	0.25 lb.	36.00	32.40	28.80	25.20
304561	12" X 18"	0.25 lb.	40.00	36.00	32.00	28.00
304562	16" X 24"	0.25 lb.	44.00	39.60	35.20	30.80
304563	2' X 3'	0.25 lb.	50.00	45.00	40.00	35.00
304564	2.5' X 4'	0.4 lb.	70.00	63.00	56.00	49.00
304565	3' X 5'	0.5 lb.	80.00	72.00	64.00	56.00
304566	4' X 6'	0.7 lb.	110.00	99.00	88.00	77.00
304567	5' X 8'	1 lb.	160.00	152.00	144.00	136.00
304568	6' X 10'	1.6 lbs.	230.00	219.00	207.00	196.00

USD MSRP (C)

Burgee Nylon Flag (Double-Sided)

Item #	Size	Product Wt.	1	2-5	6-11	12-24
304570	8" X 12"	0.75 lb.	72.00	64.80	57.60	50.40
304571	12" X 18"	0.75 lb.	80.00	72.00	64.00	56.00
304572	16" X 24"	0.75 lb.	88.00	79.20	70.40	61.60
304573	2' X 3'	0.75 lb.	100.00	90.00	80.00	70.00
304574	2.5' X 4'	1.2 lbs.	140.00	126.00	112.00	98.00
304575	3' X 5'	1.5 lbs.	160.00	144.00	128.00	112.00
304576	4' X 6'	2.1 lbs.	220.00	198.00	176.00	154.00
304577	5' X 8'	3 lbs.	320.00	304.00	288.00	272.00
304578	6' X 10'	4.8 lbs.	460.00	437.00	414.00	391.00

USD MSRP (C)



Burgee: Traditionally used for signaling and identifying watercraft

Setup fee: \$20.00(G); no setup fee on orders placed via our website; see page 224 for details.
View current graphic templates, assembly videos and instructions on our website.
See pages 224-226 for additional information that may apply to your order.

AFTER FINAL PROOF APPROVAL
PRODUCTION LEAD TIME IS
4 DAYS

U.S. FLAG

Let your patriotism fly high with these beautifully constructed heavyweight flags.

- Flags are constructed of the finest nylon or special woven two-ply polyester
- Nylon flag fabric is dyed with UV protected fade-resistant inks for longer-lasting colors with seamless transitions; best for outdoor use
- Flags feature hand-sewn stripes for an authentic high-quality flag
- Superior wearing quality dries quickly and resists fading
- Flags used outdoors have a 90-day warranty; flags used indoors have a 1-year warranty



Flags up to 6'x10' are finished with a white canvas header and brass grommets; 8'x12' and larger are finished with a rope and thimble header.



Flags feature full white embroidered stars, no gaps.

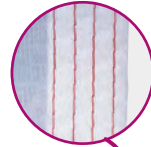

Fly end is finished with 4-row lock-stitching.



Flags utilize a quarter-inch turn-in on all seams to reduce fraying.



United States Nylon Flag

Item #	Size	Product Wt.	1
48402	2' x 3'	0.3 lb.	16.50
48403	3' x 5'	0.6 lb.	21.25
48404	4' x 6'	0.85 lb.	34.75
48405	5' x 8'	1.3 lbs.	52.50
484059	5' x 9.5'	1.5 lbs.	71.75
48406	6' x 10'	1.9 lbs.	80.00
48408	8' x 12'	3.1 lbs.	150.00
48410	10' x 15'	5.3 lbs.	218.25

USD MSRP (C)

United States Polyester Flag

Item #	Size	Product Wt.	1
48803	3' x 5'	1 lb.	31.25
48804	4' x 6'	1.5 lbs.	43.50
48805	5' x 8'	2.2 lbs.	68.50
48806	6' x 10'	3.3 lbs.	103.50
48808	8' x 12'	5.3 lbs.	173.50
48810	10' x 15'	8.5 lbs.	258.50
48812	12' x 18'	11.9 lbs.	380.00
48815	15' x 25'	19.7 lbs.	650.00

USD MSRP (C)

SHIPS SAME DAY
WHEN ORDERED BEFORE 2PM CENTRAL

View current graphic templates, assembly videos and instructions on our website. See pages 224-226 for additional information that may apply to your order.



MILITARY FLAGS

Show your military pride with a flag representing the branch you support or serve.

- Constructed of 200 denier nylon
- Choose from all standard military branches and POW/MIA flags
- Military branch flags are single-sided
- POW/MIA flags are available single- and double-sided
- Great for indoor or outdoor use
- Great flyability, even in the slightest breeze
- Finished with canvas header and brass grommets
- Flags used outdoors have a 90-day warranty;
- Flags used indoors have a 1-year warranty



POW - MIA



U.S. Marine Corps



U.S. Army



U.S. Navy



U.S. Coast Guard



U.S. Air Force

POW-MIA Flag

Item #	Size	Product Wt.	1
424PO02	2' x 3' Flag Single-Sided	0.25 lb.	18.00
424PO02D	2' x 3' Flag Double-Sided	0.9 lb.	38.00
424PO03	3' x 5' Flag Single-Sided	0.5 lb.	32.00
424PO03B	3' x 5' Flag Double-Sided	1.5 lbs.	67.00
424PO04	4' x 6' Flag Single-Sided	0.7 lb.	49.00
424PO04D	4' x 6' Flag Double-Sided	2.1 lbs.	103.00
424PO05	5' x 8' Flag Single-Sided	1 lb.	83.00
424PO05D	5' x 8' Flag Double-Sided	3 lbs.	175.00
424PO06	6' x 10' Flag Single-Sided	1.6 lbs.	120.00
424PO06D	6' x 10' Flag Double-Sided	4.8 lbs.	252.00

USD MSRP (C)

Military Flags

Item #	Size	Product Wt.	1
285810	2' x 3'	0.25 lb.	18.00
285811	3' x 5'	0.5 lb.	32.00
285812	4' x 6'	0.7 lb.	49.00
285813	5' x 8'	1 lb.	83.00
285814	6' x 10'	1.6 lbs.	120.00

USD MSRP (C)

View current graphic templates, assembly videos and instructions on our website. See pages 224-226 for additional information that may apply to your order.

AFTER FINAL PROOF APPROVAL
PRODUCTION LEAD TIME IS
4 DAYS



Jolly Roger



Fleur De Lis



First Navy Jack

**NEW
PRODUCT**

**MORE
OPTIONS
ONLINE**

HISTORICAL FLAGS

Travel back in time and capture an important moment with these nylon flags.

- Great for indoor or outdoor use
- Artwork is printed on 200 denier nylon
- Finished with canvas header and brass grommets
- Flags are single-sided
- Great flyability, even in the slightest breeze
- See the complete selection of Historical Flags available online
- Flags used outdoors have a 90-day warranty; flags used indoors have a 1-year warranty



Historical Flags

Item #	Size	Product Wt.	1
286020	2' x 3'	0.25 lb.	25.00
286021	3' x 5'	0.5 lb.	45.00
286022	4' x 6'	0.7 lb.	63.00
286023	5' x 8'	1 lb.	94.00
286024	6' x 10'	1.6 lbs.	140.00

USD MSRP (C)



INTERNATIONAL FLAGS

Rugged enough to withstand outdoor use, these single-sided flags feature brilliant colors to showcase the nation of your choosing.

- Great for indoor or outdoor use
- Artwork is printed on 200 denier nylon
- Finished with canvas header and brass grommets
- Great flyability, even in the slightest breeze
- See the complete selection of International Flags available online
- Flags used outdoors have a 90-day warranty; flags used indoors have a 1-year warranty



**NEW
PRODUCT**

**MORE
OPTIONS
ONLINE**

International Flags

Item #	Size	Product Wt.	1
285820	2' x 3'	0.25 lb.	25.00
285821	3' x 5'	0.5 lb.	45.00
285822	4' x 6'	0.7 lb.	63.00
285823	5' x 8'	1 lb.	94.00
285824	6' x 10'	1.6 lbs.	140.00

USD MSRP (C)

AFTER FINAL PROOF APPROVAL
PRODUCTION LEAD TIME IS
4 DAYS

View current graphic templates, assembly videos and instructions on our website.
See pages 224-226 for additional information that may apply to your order.

STATE FLAGS

Fly your state flag with pride and let us know where you're from. We offer flags for all 50 states as well as U.S. territories.

- Great for indoor or outdoor use
- Artwork is printed on 200 denier nylon
- Finished with canvas header and brass grommets
- Flags are single-sided
- Great flyability, even in the slightest breeze
- See the complete selection of State Flags available online
- Flags used outdoors have a 90-day warranty; flags used indoors have a 1-year warranty



Minnesota

**NEW
PRODUCT**

**MORE
OPTIONS
ONLINE**

Maryland

Colorado

State Flags

Item #	Size	Product Wt.	1
285800	2' x 3'	0.25 lb.	18.00
285801	3' x 5'	0.5 lb.	32.00
285802	4' x 6'	0.7 lb.	49.00
285803	5' x 8'	1 lb.	83.00
285804	6' x 10'	1.6 lbs.	120.00

USD MSRP (C)

CITY FLAGS

These brilliantly dyed nylon flags are built to last and feature prominent cities across the US.

- Great for indoor or outdoor use
- Artwork is printed on 200 denier nylon
- Finished with canvas header and brass grommets
- Flags are single-sided
- Great flyability, even in the slightest breeze
- See the complete selection of City Flags available online
- Flags used outdoors have a 90-day warranty; flags used indoors have a 1-year warranty



**NEW
PRODUCT**

**MORE
OPTIONS
ONLINE**



Albuquerque

Chicago

Dallas

City Flags

Item #	Size	Product Wt.	1
286001	2' x 3'	0.25 lb.	25.00
286002	3' x 5'	0.5 lb.	45.00
286003	4' x 6'	0.7 lb.	63.00
286004	5' x 8'	1 lb.	94.00
286005	6' x 10'	1.6 lbs.	140.00

USD MSRP (C)

View current graphic templates, assembly videos and instructions on our website. See pages 224-226 for additional information that may apply to your order.

AFTER FINAL PROOF APPROVAL
PRODUCTION LEAD TIME IS
4 DAYS



Presbyterian

Vatican Papal

United Methodist

NEW PRODUCT

MORE OPTIONS ONLINE

RELIGIOUS FLAGS

These reverent flags will look great outside your place of worship.

- Great for indoor or outdoor use
- Artwork is printed on 200 denier nylon
- Finished with canvas header and brass grommets
- Flags are single-sided
- Great flyability, even in the slightest breeze
- See the complete list of Religious Flags available online
- Flags used outdoors have a 90-day warranty; flags used indoors have a 1-year warranty



Religious Flags

Item #	Size	Product Wt.	1
286010	2' x 3'	0.25 lb.	25.00
286011	3' x 5'	0.5 lb.	45.00
286012	4' x 6'	0.7 lb.	63.00
286013	5' x 8'	1 lb.	94.00
286014	6' x 10'	1.6 lbs.	140.00

USD MSRP (C)



NEW PRODUCT

SOLID COLOR FLAG

These brilliantly colored flags command attention in any environment.

- Standard finishing includes canvas header and brass grommets
- Multiple finishing styles available (see page 73 for popular options)
- Constructed of 200 denier nylon
- Four rows of lock-stitching provides extra reinforcement on the fly end of the flag
- Great for indoor or outdoor use
- Features a single stock color across the entire flag
- 26 color options to choose from
- Flags used outdoors have a 90-day warranty; flags used indoors have a 1-year warranty



Solid Color Flag

Item #	Size	Product Wt.	1
304516	2' x 3'	1 lb.	17.00
304517	3' x 5'	1 lb.	26.00
304518	4' x 6'	1.25 lbs.	40.00
304519	5' x 8'	1.5 lbs.	60.00

USD MSRP (C)

Stock Flag Colors

Bell Blue PMS 641	French Blue PMS 285	Pansy PMS 2617
Black	Gray PMS 7538	Purple PMS 2695
Buff PMS 141	Irish Green PMS 349	Royal Blue PMS 286
Canada Red PMS 186	Legion Blue PMS 2756	Silver PMS 7534
Charcoal PMS 424	Maroon PMS 5115	Spice Brown PMS 1545
Daffodil PMS 108	Mint Green PMS 360	Spanish Yellow PMS 1235
Dartmouth PMS 350	OG Blue PMS 2768	UN Blue PMS 279
Emerald 3425	OG Red PMS 187	White
FM Yellow PMS 106	Orange PMS 172	

PMS colors are for reference only and may vary slightly from actual color.

View current graphic templates, assembly videos and instructions on our website. See pages 224-226 for additional information that may apply to your order.

4 DAYS
AFTER FINAL PROOF APPROVAL
PRODUCTION LEAD TIME IS

MESSAGE FLAG

Adorn your flagpole with a timeless message. Choose from our stock message options or write your own.

- Constructed of 200 denier nylon
- Finished with canvas header and brass grommets
- Four rows of lock-stitching provides extra reinforcement on the fly end of the flag
- Great for indoor or outdoor use
- Features red, white and blue sewn stripes with your custom message or a stock message printed on the white stripe in black letters
- 15 stock messages to choose from
- Custom option lets you choose your message; 35 character maximum
- Flags used outdoors have a 90-day warranty; flags used indoors have a 1-year warranty



Message Flag

Item #	Size	Product Wt.	1
304706	3' x 5' Stock Message	1 lb.	28.00
304709	3' x 5' Custom Message	1 lb.	55.00

USD MSRP (C)

Stock Message Options



FABRIC FLAG

Easy to hang, this flag works with any standard flagpole.

- Best for outdoor use
- Single-sided and double-sided options available
- Artwork is dye sublimated on super poly knit fabric
- Double-sided flags feature two layers sewn together with a block-out liner in between
- Custom sizes available (call for quote; restrictions may apply)
- Flags used outdoors have a 90-day warranty; flags used indoors have a 1-year warranty



Fabric Flag

Item #	Size	Product Wt.	1	2-5	6-11	12-24
300003	2' x 3' Flag Single-Sided	0.25 lb.	50.00	44.00	39.00	35.00
300018	2' x 3' Flag Double-Sided	0.5 lb.	100.00	87.00	78.00	69.00
300007	3' x 5' Flag Single-Sided	0.5 lb.	80.00	72.00	67.00	62.00
300019	3' x 5' Flag Double-Sided	1.25 lbs.	160.00	144.00	134.00	124.00
300011	4' x 6' Flag Single-Sided	1 lb.	110.00	99.00	92.00	85.00
300020	4' x 6' Flag Double-Sided	2 lbs.	220.00	198.00	184.00	171.00
300015	5' x 8' Flag Single-Sided	1 lb.	148.00	141.00	134.00	127.00
300021	5' x 8' Flag Double-Sided	3.25 lbs.	296.00	282.00	268.00	254.00

USD MSRP (C)

Single-sided flags are printed on one side; reverse image shows through the back.



All flags are finished with white canvas heading and brass grommets.

Setup fee: \$20.00(G); no setup fee on orders placed via our website; see page 224 for details. View current graphic templates, assembly videos and instructions on our website. See pages 224-226 for additional information that may apply to your order.

STOCK MESSAGE SHIPS **SAMEDAY** OR **4 DAYS** AFTER FINAL PROOF APPROVAL
WHEN ORDERED BEFORE 2PM CENTRAL
CUSTOM & FABRIC PRODUCTION LEAD TIME IS



Suggested Uses:
 Small Businesses
 Sports Teams
 Holidays
 Patriotic Events

CAR FLAG

Car flags are a great way to get attention while on the road.

- Can be used on cars in motion (45 MPH maximum speed)
- Artwork is dye sublimated on super poly knit fabric
- Single-sided and double-sided options available
- Double-sided flags feature two layers sewn together with a block-out liner in between
- 1.5" pole sleeve is closed at the top to prevent the flag from sliding down the pole
- The bottom of the sleeve features a leather tab that is zip-tied to the pole
- The Car Flag premium pole is constructed of high gauge plastic
- 30-day warranty on flag



Car Flag

Item #	Size	Product Wt.	1	2-5	6-11	12-24
304690	18" x 12" Single-Sided Kit	0.5 lb.	58.00	52.20	46.40	40.60
304691	18" x 12" Double-Sided Kit	1 lb.	116.00	104.40	92.80	81.20

Kit Includes: Pole and Flag USD MSRP (C)



To install, simply place the flagpole's clip on your window and roll up the window.

Canvas header flag



Suggested Uses:
 Tournaments
 Fundraisers
 Company Events
 Mini Golf Courses

GOLF FLAG

This golf flag will give your course or event a personalized touch.

- Flags available with canvas header and grommets or sewn-in golf tube
- Artwork is printed on 200 denier nylon
- Single-sided and double-sided options available
- Single-sided flags show artwork on one side with the reverse image visible through the back
- Double-sided flags feature two layers sewn together with a block-out liner in between
- Flags used outdoors have a 90-day warranty; flags used indoors have a 1-year warranty



Golf Flag

Item #	Description	Product Wt.	1	2-5	6-11	12-24
304620	20" x 14" Canvas Header Flag Single-Sided	0.25 lb.	52.00	46.80	41.60	36.40
304621	20" x 14" Tube Flag Single-Sided	1 lb.	60.00	54.00	48.00	42.00
304622	20" x 14" Canvas Header Flag Double-Sided	1 lb.	104.00	93.60	83.20	72.80
304623	20" x 14" Tube Flag Double-Sided	1.75 lbs.	120.00	108.00	96.00	84.00

USD MSRP (C)



Tube flag

4 DAYS
AFTER FINAL PROOF APPROVAL
 PRODUCTION LEAD TIME IS

Setup fee: \$20.00(G); no setup fee on orders placed via our website; see page 224 for details.
 View current graphic templates, assembly videos and instructions on our website.
 See pages 224-226 for additional information that may apply to your order.

SPIRIT FLAG

The Spirit Flag is a great way to energize the crowd. Your team name or mascot will be vibrantly dye sublimated for the whole stadium to see.

- Single-sided and double-sided options available
- Artwork is printed on 200 denier nylon
- 3" pole sleeve is closed at the top to prevent the flag from sliding down the pole
- Flags used outdoors have a 90-day warranty; flags used indoors have a 1-year warranty



Spirit Flag

Item #	Description	Product Wt.	1	2-5	6-11	12-24
304650	3' X 5' Single-Sided Kit	1.45 lbs.	115.00	109.00	104.00	98.00
304651	3' X 5' Double-Sided Kit	2.35 lbs.	189.00	180.00	170.00	161.00
304654	4' X 6' Single-Sided Kit	1.7 lbs.	139.00	132.00	125.00	118.00
304655	4' X 6' Double-Sided Kit	3.1 lbs.	236.00	224.00	212.00	201.00
304658	5' X 8' Single-Sided Kit	2 lbs.	184.00	175.00	166.00	156.00
304659	5' X 8' Double-Sided Kit	4 lbs.	325.00	315.00	310.00	295.00
304662	6' X 10' Single-Sided Kit	4 lbs.	273.00	259.00	246.00	232.00
304663	6' X 10' Double-Sided Kit	5.6 lbs.	480.00	465.00	455.00	435.00
304666	8' X 12' Single-Sided Kit	7 lbs.	475.00	460.00	450.00	430.00
304667	8' X 12' Double-Sided Kit	12.7 lbs.	875.00	850.00	830.00	795.00

Kit Includes: Flag and Pole Hardware USD MSRP (C)



Double-needle hem on the top and bottom; four rows of stitching on the fly end.



The bottom of the sleeve features a leather tab that can be zip-tied to the pole.



Suggested Uses:

- Parades
- Political Rallies
- Festivals
- Celebrations

BODY FLAG

Wear your pride on your sleeve – and across your back – with this body flag.

- Great for parades and events
- Flags are 3' x 5'
- Constructed of flame-retardant 100 denier polyester
- Flows like a cape as you move



Body Flag

Item #	Description	Product Wt.	1
285868	USA	4.9 oz.	30.00
285865	Pride	4.9 oz.	30.00
285867	Mardi Gras	4.9 oz.	30.00
285869	St. Patrick's Day	4.9 oz.	30.00

USD MSRP (C)



Setup fee: \$20.00(G); no setup fee on orders placed via our website; see page 224 for details. View current graphic templates, assembly videos and instructions on our website. See pages 224-226 for additional information that may apply to your order.

4 DAYS SHIPS SAME DAY
AFTER FINAL PROOF APPROVAL PRODUCTION LEAD TIME IS 6 DAYS
WHEN ORDERED BEFORE 2PM CENTRAL

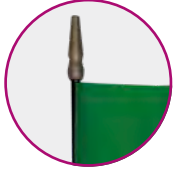

Flags feature a black staff with a gold spear on top.

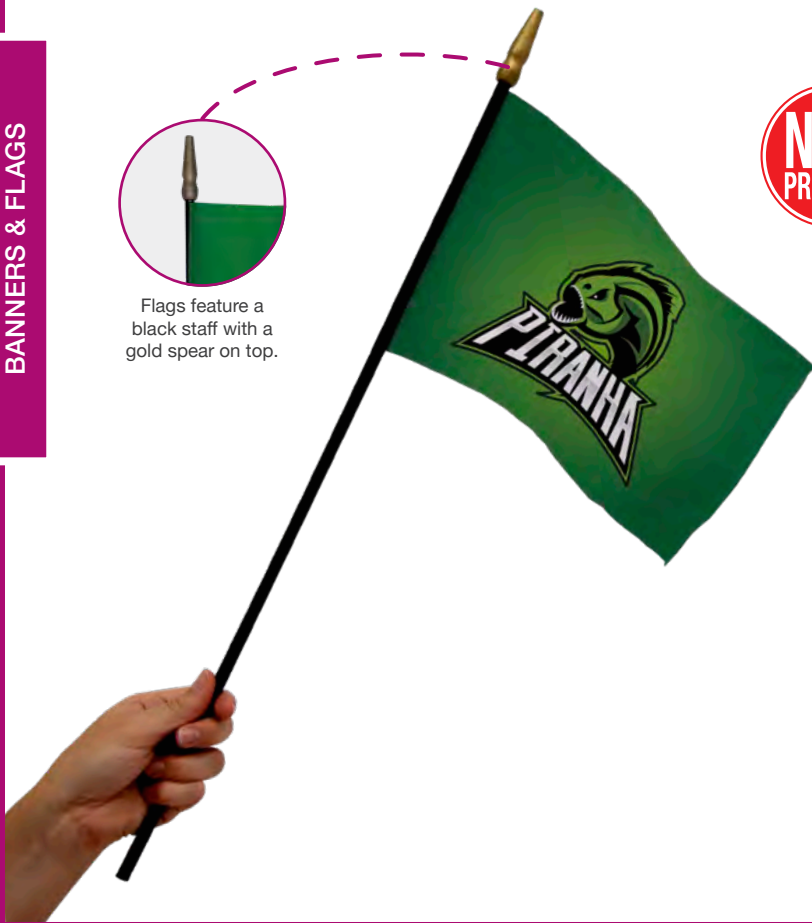

Suggested Uses:
Sporting Events
Rallies
Festivals
Trade Shows

STICK FLAG

Wave your flag and hold it high! These mini flags are great on desk tops or for handing out as mementos.

- Great for parades and interactive events
- Sold in sets of six
- Flag is single-sided
- Artwork is printed on taffeta material
- Flags used outdoors have a 90-day warranty; flags used indoors have a 1-year warranty



Stick Flag

Item #	Description	Product Wt.	1	2-5	6-11	12-24
304640	4" x 6" (Set of 6)	0.9 lb.	72.00	64.80	57.60	50.40
304641	6" x 9" (Set of 6)	1.2 lbs.	84.00	75.60	67.20	58.80
304642	8" x 12" (Set of 6)	1.8 lbs.	120.00	108.00	96.00	84.00
304643	12" x 18" (Set of 6)	2.1 lbs.	144.00	129.60	115.20	100.80
304644	16" x 24" (Set of 6)	2.7 lbs.	156.00	140.40	124.80	109.20

USD MSRP (C)



Suggested Uses:
Entrances
Conservatories
Cemeteries
City Parks

GARDEN FLAG

Garden flags are great for use at events or in public spaces.

- Artwork is printed on 200 denier nylon
- Single-sided and double-sided options available
- Single-sided flags show artwork on one side with the reverse image visible through the back
- Double-sided flags feature two layers sewn together with a block-out liner in between
- Flags used outdoors have a 90-day warranty; flags used indoors have a 1-year warranty



Garden Flag

Item #	Size	Product Wt.	1	2-5	6-11	12-24
304630	12" x 18" Single-Sided Kit	1.25 lbs.	53.00	50.00	48.00	45.00
304631	12" x 18" Double-Sided Kit	1.5 lbs.	89.00	85.00	80.00	76.00
304635	30" x 48" Single-Sided Kit	5.5 lbs.	138.00	131.00	124.00	117.00
304636	30" x 48" Double-Sided Kit	6 lbs.	218.00	207.00	196.00	185.00

Kit Includes: Hardware and Flag
USD MSRP (C)

AFTER FINAL PROOF APPROVAL
PRODUCTION LEAD TIME IS
4 DAYS

Setup fee: \$20.00(G); no setup fee on orders placed via our website; see page 224 for details.
View current graphic templates, assembly videos and instructions on our website.
See pages 224-226 for additional information that may apply to your order.



PATRIOTIC PLEATED

- Traditional pleated fan gives patriotic events a spirited touch
- Polycotton material
- Hemmed with a header and three grommets



PATRIOTIC MIRAGE

- Try this budget-friendly alternative to traditional pleated fans
- Polycotton material
- Hemmed with a header and three grommets



Printed image gives the appearance of a 3D pleated surface.



PRIDE PLEATED

- Display your pride on decks, balconies, windows and parade floats
- 100 denier polyester
- Hemmed with a canvas header and three grommets

FANS

Dress up your balconies, decks, windows, and parade floats with these festive fans.



Fans

Item #	Description	1
454033	3' x 6' Patriotic Pleated	59.50
45423MPF	2' x 3' Patriotic Mirage	15.50
45435MPF	3' x 5' Patriotic Mirage	18.00
285864	30" x 60" Pride Pleated	35.00
285859	30" x 60" Mardi Gras Pleated	29.00

USD MSRP (C)



MARDI GRAS PLEATED

- Bring the festive colors of Mardi Gras to your parade or party
- Pleated fan is constructed of 100 denier polyester
- Hemmed with a canvas header and three grommets

BUNTING

Choose from two popular bunting options to add patriotic flair to any parade or event.

- Red, white and blue stripes bunting is composed of 36" wide heavy cotton with 12" sewn stripes
- Stars and Stripes Bunting features 18" wide by 20' long polycotton printed with solid red and white stripes and a star-studded blue center



Bunting

Item #	Description	1
4540055	36"W Red, White & Blue Stripes (by the yard)	8.25
4540020	18" x 20' Roll Stars and Stripes	30.00

USD MSRP (C)



Red, White and Blue Stripes

Stars and Stripes

PENNANT STRING

Dress up your balconies, decks, windows, and parade floats with these festive pennants.

- Single-sided pennants are printed on Titan™ 13 oz. Scrim Vinyl; double-sided pennants are printed on Titan™ 18 oz. Opaque Scrim Vinyl
- Pennants are 9" x 12"; 20' strings feature 11 pennants, 30' strings feature 16 pennants
- Custom pennant strings available (call for quote; restrictions may apply)
- Pennants used outdoors have a 90-day warranty; pennants used indoors have a 1-year warranty



Pennant String

Item #	Description	Product Wt.	1	2-5	6-11	12-24
304770	20' Single-Sided	0.6 lb.	91.00	86.00	82.00	77.00
304771	30' Single-Sided	0.8 lb.	133.00	126.00	120.00	113.00
304772	20' Double-Sided	0.8 lb.	146.00	139.00	131.00	124.00
304773	30' Double-Sided	1 lb.	213.00	202.00	192.00	181.00

USD MSRP (C)



Setup fee: \$20.00(G); no setup fee on orders placed via our website; see page 224 for details. View current graphic templates, assembly videos and instructions on our website. See pages 224-226 for additional information that may apply to your order.

FANS & BUNTING SHIPS **SAMEDAY** OR **4 DAYS** AFTER FINAL PROOF APPROVAL. WHEN ORDERED BEFORE 2PM CENTRAL. PRODUCTION LEAD TIME IS

SAIL SIGNS

HIGH-IMPACT FLAGS THAT FLUTTER IN THE WIND.



GOOD

Value Sail Signs

- Vibrant dye sublimation on super poly knit fabric
- Value hardware
- Value spike or Value cross base

BETTER

Streamline Sail Signs

- Vibrant dye sublimation on super poly knit fabric
- Premium hardware
- Ground spike, scissor base or three-legged base

BEST

Premium Sail Signs

- Vibrant dye sublimation on super poly knit fabric
- Premium hardware
- Ground spike, scissor base or three-legged base

HARDWARE COMPARISON CHART

	POLE CONSTRUCTION	FLAG ATTACHMENT	CARRY CASE	HARDWARE WARRANTY
Value Hardware	 <p>Channelled carbon composite overlay construction with low-gloss black paint finish. Double-reinforced carbon fiber pole segment ends.</p>	 <p>A loop on the flag attaches to an adjustable hook on the pole.</p>	Sold separately (see page 89)	
Premium Hardware	 <p>Uniform carbon composite overlay construction with high-gloss black paint finish. Polished aluminum collar pole segment ends and ergonomic, rubber-reinforced base grip.</p>	 <p>Flag attaches to a fixed hook using a bungee cord.</p>		



Wind Test Assessment:

6'-11.5' to withstand winds up to 30 mph with use of water ballast or a ground spike in firm ground.

13'-18' to withstand winds up to 20 mph with use of water ballast or a ground spike in firm ground.

Flag Warranty: Flags used outdoors have a 90-day warranty. Flags used indoors have a 1-year warranty.

Disclaimer:

Wind rating conducted in a controlled environment. Outdoor products should be taken down if bad weather is likely. Wind gusts and heavy rain could reduce the wind resistance of these products. Flutter Flags Have not been rated for wind conditions.

MAXIMIZE THE IMPACT OF YOUR MESSAGE



Single-Sided

Reverse image shows through back.

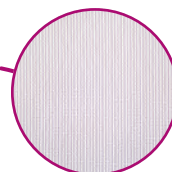

Artwork is dye sublimated on super poly knit fabric.



Double-Sided

Image on both sides with a block-out liner in between.

CUSTOMIZE WITH BASE OPTIONS

Kits include spike, cross base with water ballast, or scissor base with water ballast.

We also carry several other bases designed to work on various types of terrain; see pages 98-99.



Spike



Cross base



Scissor base



Water ballast

VALUE SAIL SIGN

Value sail signs are perfect for large-quantity orders and short-term use.

- Three classic shapes
- New Blade shape now available
- Value spike for outdoor use or value cross base for indoor/outdoor use
- Carbon composite poles are strong and flexible
- Artwork is dye sublimated on super poly knit fabric
- 90-day warranty on hardware and flag
- Can be stored and transported in our sail sign carry case (sold separately)



Suggested Uses:
Restaurants
Salons
Auto Body Shops
Sporting Events



**NEW
SHAPE**



Straight bottom edge on blade sail signs increase the usable graphic area for even bigger, bolder design possibilities.

7.5' Blade 10.5' Razor 15' Razor 13' Teardrop 10.5' Blade 6.5' Teardrop

Single- or Double-Sided



Single-Sided
Reverse image shows through back.



Double-Sided
Image on both sides with a block-out liner in between.



Channeled carbon composite overlay construction with low-gloss black paint finish.



A loop on the flag attaches to an adjustable hook on the pole.

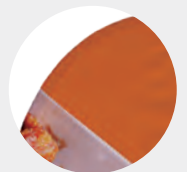

Pole pocket is made of the same fabric as the flag.



Value Blade Sail Sign

Description	Item #	Single-Sided Flag				Double-Sided Flag				
		1	2-5	6-11	12-24	Item #	1	2-5	6-11	12-24
7.5' Kit with Value Spike	191730	124.00	120.00	114.00	110.00	191732	196.00	190.00	180.00	174.00
7.5' Kit with Cross Base and Water Ballast	191731	151.00	146.00	139.00	134.00	191733	228.00	221.00	210.00	203.00
10.5' Kit with Value Spike	191736	147.00	143.00	135.00	131.00	191738	232.00	225.00	213.00	206.00
10.5' Kit with Cross Base and Water Ballast	191737	172.00	167.00	158.00	153.00	191739	261.00	253.00	240.00	232.00
15' Kit with Value Spike	191742	195.00	189.00	179.00	174.00	191744	316.00	307.00	291.00	281.00
15' Kit with Cross Base and Water Ballast	191743	226.00	219.00	208.00	201.00	191745	341.00	331.00	314.00	303.00

Kit Includes: Hardware with Specified Base and Flag (Does not include carry case) USD MSRP (C)

Description	Product Size w/Spike	Product Size w/Cross Base	Finished Graphic Size	Product Wt. (Spike / Cross)	Media
7.5'	28.5"W x 88.25"H x 1.5"D	43.5"W x 91.625"H x 23.75"D	View Online Template	3 lbs. / 4.3 lbs.	Super Poly Knit Fabric
10.5'	30.25"W x 124"H x 1.5"D	45.25"W x 127.375"H x 23.75"D	View Online Template	3.8 lbs. / 5.1 lbs.	Super Poly Knit Fabric
15'	35.5"W x 177"H x 1.5"D	50.5"W x 180.375"H x 23.75"D	View Online Template	5 lbs. / 6.3 lbs.	Super Poly Knit Fabric



Value Razor Sail Sign

Description	Item #	Single-Sided Flag				Double-Sided Flag				
		1	2-5	6-11	12-24	Item #	1	2-5	6-11	12-24
7.5' Kit with Value Spike	191650	124.00	120.00	114.00	110.00	191652	196.00	190.00	180.00	174.00
7.5' Kit with Cross Base and Water Ballast	191651	151.00	146.00	139.00	134.00	191653	228.00	221.00	210.00	203.00
10.5' Kit with Value Spike	191658	147.00	143.00	135.00	131.00	191660	232.00	225.00	213.00	206.00
10.5' Kit with Cross Base and Water Ballast	191659	172.00	167.00	158.00	153.00	191661	261.00	253.00	240.00	232.00
15' Kit with Value Spike	191666	195.00	189.00	179.00	174.00	191668	316.00	307.00	291.00	281.00
15' Kit with Cross Base and Water Ballast	191667	226.00	219.00	208.00	201.00	191669	341.00	331.00	314.00	303.00

Kit Includes: Hardware with Specified Base and Flag (Does not include carry case) USD MSRP (C)

Description	Product Size w/Spike	Product Size w/Cross Base	Finished Graphic Size	Product Wt. (Spike / Cross)	Media
7.5'	28.5"W x 88.25"H x 1.5"D	43.5"W x 91.625"H x 23.75"D	View Online Template	3 lbs. / 4.3 lbs.	Super Poly Knit Fabric
10.5'	30.25"W x 124"H x 1.5"D	45.25"W x 127.375"H x 23.75"D	View Online Template	3.8 lbs. / 5.1 lbs.	Super Poly Knit Fabric
15'	35.5"W x 177"H x 1.5"D	50.5"W x 180.375"H x 23.75"D	View Online Template	5 lbs. / 6.3 lbs.	Super Poly Knit Fabric



Value Teardrop Sail Sign

Description	Item #	Single-Sided Flag				Double-Sided Flag				
		1	2-5	6-11	12-24	Item #	1	2-5	6-11	12-24
6.5' Kit with Value Spike	191610	124.00	120.00	114.00	110.00	191612	196.00	190.00	180.00	174.00
6.5' Kit with Cross Base and Water Ballast	191611	151.00	146.00	139.00	134.00	191613	228.00	221.00	210.00	203.00
9.5' Kit with Value Spike	191618	147.00	143.00	135.00	131.00	191620	232.00	225.00	213.00	206.00
9.5' Kit with Cross Base and Water Ballast	191619	172.00	167.00	158.00	153.00	191621	261.00	253.00	240.00	232.00
13' Kit with Value Spike	191626	195.00	189.00	179.00	174.00	191628	316.00	307.00	291.00	281.00
13' Kit with Cross Base and Water Ballast	191627	226.00	219.00	208.00	201.00	191629	341.00	331.00	314.00	303.00

Kit Includes: Hardware with Specified Base and Flag (Does not include carry case) USD MSRP (C)

Description	Product Size w/Spike	Product Size w/Cross Base	Finished Graphic Size	Product Wt. (Spike / Cross)	Media
6.5'	34.25"W x 78.5"H x 1.5"D	49.25"W x 81.875"H x 23.75"D	View Online Template	2.8 lbs. / 4.1 lbs.	Super Poly Knit Fabric
9.5'	44.25"W x 112.5"H x 1.5"D	59.25"W x 115.875"H x 23.75"D	View Online Template	3.4 lbs. / 4.7 lbs.	Super Poly Knit Fabric
13'	51.5"W x 154"H x 1.5"D	66.5"W x 157.375"H x 23.75"D	View Online Template	4.4 lbs. / 5.7 lbs.	Super Poly Knit Fabric



Value Sail Sign Bases and Optional Carry Case

Item #	Description	Product Wt.	1	2-5	6-11	12-24
191590	Value Spike	2 lbs.	31.60	30.70	29.10	28.10
191591	Value Cross Base	2.8 lbs.	31.60	30.70	29.10	28.10
220097	Sail Sign Soft Carry Case	1 lb.	33.20	32.20	30.50	29.50

USD MSRP (C)



Add-Ons

HARDWARE ONLY LEAD TIME: SHIPS SAME DAY WHEN ORDERED BEFORE 2 PM CENTRAL
 Setup fee: \$20.00(G); no setup fee on orders placed via our website; see page 224 for details.
 View current graphic templates, assembly videos and instructions on our website.
 See pages 224-226 for additional information that may apply to your order.

AFTER FINAL PROOF APPROVAL
 PRODUCTION LEAD TIME IS
4 DAYS

STREAMLINE SAIL SIGN

On Streamline sail signs, your artwork doesn't stop at the pole pocket.

- Sizes range from 6' to 17' tall
- New Blade shape now available
- Carbon composite poles are strong and flexible
- Artwork is dye sublimated on super poly knit fabric
- Flags used outdoors have a 90-day warranty; flags used indoors have a 1-year warranty
- Lifetime warranty on pole hardware



Suggested Uses:
Retail Promotions
Shopping Malls
Libraries
Town Halls



Straight bottom edge on blade sail signs increase the usable graphic area for even bigger, bolder design possibilities.

7' Blade 10' Rectangle 13' Sabre 15' Teardrop 14.5' Rectangle 13' Razor 9' Sabre 6' Teardrop

Single- or Double-Sided



Single-Sided
Reverse image shows through back.



Double-Sided
Image on both sides with a block-out liner in between.



Uniform carbon composite overlay construction with high-gloss black paint finish.



Flag attaches to a fixed hook using a bungee cord.



Pole pocket is made of the same fabric as the flag.

Streamline Blade Sail Sign

Description	Item #	Single-Sided Flag				Double-Sided Flag				
		1	2-5	6-11	12-24	Item #	1	2-5	6-11	12-24
7' Kit with Ground Spike	191490	180.00	175.00	166.00	160.00	191492	261.00	253.00	240.00	232.00
7' Kit with Three-Legged Base and Water Ballast	191491	212.00	206.00	195.00	189.00	191493	293.00	284.00	270.00	261.00
9' Kit with Ground Spike	191496	202.00	196.00	186.00	180.00	191498	296.00	287.00	272.00	263.00
9' Kit with Scissor Base and Water Ballast	191497	268.00	260.00	247.00	239.00	191499	362.00	351.00	333.00	322.00
13' Kit with Ground Spike	191502	250.00	243.00	230.00	223.00	191504	383.00	372.00	352.00	341.00
13' Kit with Scissor Base and Water Ballast	191503	316.00	307.00	291.00	281.00	191505	449.00	436.00	413.00	400.00
17' Kit with Ground Spike	191508	308.00	299.00	283.00	274.00	191510	476.00	462.00	445.00	430.00
17' Kit with Scissor Base and Water Ballast	191509	374.00	363.00	344.00	333.00	191511	542.00	526.00	505.00	489.00

Kit Includes: Hardware with Specified Base, Flag and Soft Carry Case

USD MSRP (C)

Description	Product Size w/Ground Spike	Product Size w/Scissor Base	Finished Graphic Size	Product Wt. (Spike / Scissor)	Media
7'	19.75"W x 81.5"H x 2"D	28.375"W x 83.5"H x 15.25"D	View Online Template	3 lbs. / 2.75 lbs.	Super Poly Knit Fabric
9'	29"W x 106"H x 2"D	40.5"W x 108"H x 23"D	View Online Template	4.75 lbs. / 10.25 lbs.	Super Poly Knit Fabric
13'	32"W x 151"H x 2"D	43.5"W x 153"H x 23"D	View Online Template	6.75 lbs. / 10.75 lbs.	Super Poly Knit Fabric
17'	36"W x 205"H x 2"D	47.5"W x 207"H x 23"D	View Online Template	8.75 lbs. / 14.25 lbs.	Super Poly Knit Fabric



Streamline Razor Sail Sign

Description	Item #	Single-Sided Flag				Double-Sided Flag				
		1	2-5	6-11	12-24	Item #	1	2-5	6-11	12-24
7' Kit with Ground Spike	191428	180.00	175.00	166.00	160.00	191436	261.00	253.00	240.00	232.00
7' Kit with Three-Legged Base and Water Ballast	191429	212.00	206.00	195.00	189.00	191437	293.00	284.00	270.00	261.00
9' Kit with Ground Spike	191430	202.00	196.00	186.00	180.00	191438	296.00	287.00	272.00	263.00
9' Kit with Scissor Base and Water Ballast	191431	268.00	260.00	247.00	239.00	191439	362.00	351.00	333.00	322.00
13' Kit with Ground Spike	191432	250.00	243.00	230.00	223.00	191440	383.00	372.00	352.00	341.00
13' Kit with Scissor Base and Water Ballast	191433	316.00	307.00	291.00	281.00	191441	449.00	436.00	413.00	400.00
17' Kit with Ground Spike	191434	308.00	299.00	283.00	274.00	191442	476.00	462.00	445.00	430.00
17' Kit with Scissor Base and Water Ballast	191435	374.00	363.00	344.00	333.00	191443	542.00	526.00	505.00	489.00

Kit Includes: Hardware with Specified Base, Flag and Soft Carry Case

USD MSRP (C)

Description	Product Size w/Ground Spike	Product Size w/Scissor Base	Finished Graphic Size	Product Wt. (Spike / Scissor)	Media
7'	19.75"W x 81.5"H x 2"D	28.375"W x 83.5"H x 15.25"D	View Online Template	3 lbs. / 2.75 lbs.	Super Poly Knit Fabric
9'	29"W x 106"H x 2"D	40.5"W x 108"H x 22.75"D	View Online Template	4.75 lbs. / 10.25 lbs.	Super Poly Knit Fabric
13'	32"W x 151"H x 2"D	43.5"W x 153"H x 22.75"D	View Online Template	6.75 lbs. / 12.25 lbs.	Super Poly Knit Fabric
17'	36"W x 205"H x 2"D	47.5"W x 207"H x 22.75"D	View Online Template	8.75 lbs. / 14.25 lbs.	Super Poly Knit Fabric



Streamline Teardrop Sail Sign

Description	Item #	Single-Sided Flag				Double-Sided Flag				
		1	2-5	6-11	12-24	Item #	1	2-5	6-11	12-24
6' Kit with Ground Spike	191400	180.00	175.00	166.00	160.00	191408	261.00	253.00	240.00	232.00
6' Kit with Three-Legged Base and Water Ballast	191401	212.00	206.00	195.00	189.00	191409	293.00	284.00	270.00	261.00
8' Kit with Ground Spike	191402	202.00	196.00	186.00	180.00	191410	296.00	287.00	272.00	263.00
8' Kit with Scissor Base and Water Ballast	191403	268.00	260.00	247.00	239.00	191411	362.00	351.00	333.00	322.00
11.5' Kit with Ground Spike	191404	250.00	243.00	230.00	223.00	191412	383.00	372.00	352.00	341.00
11.5' Kit with Scissor Base and Water Ballast	191405	316.00	307.00	291.00	281.00	191413	449.00	436.00	413.00	400.00
15' Kit with Ground Spike	191406	308.00	299.00	283.00	274.00	191414	476.00	462.00	445.00	430.00
15' Kit with Scissor Base and Water Ballast	191407	374.00	363.00	344.00	333.00	191415	542.00	526.00	505.00	489.00

Kit Includes: Hardware with Specified Base, Flag and Soft Carry Case

USD MSRP (C)

Description	Product Size w/Ground Spike	Product Size w/Scissor Base	Finished Graphic Size	Product Wt. (Spike / Scissor)	Media
6'	23.25"W x 72.5"H x 2"D	31.875"W x 74.5"H x 15.25"D	View Online Template	2.75 lbs. / 2.5 lbs.	Super Poly Knit Fabric
8'	30.5"W x 91.5"H x 2"D	42"W x 93.5"H x 22.75"D	View Online Template	4.75 lbs. / 10.25 lbs.	Super Poly Knit Fabric
11.5'	36"W x 144.5"H x 2"D	47.5"W x 146.5"H x 22.75"D	View Online Template	7.25 lbs. / 12.75 lbs.	Super Poly Knit Fabric
15'	40"W x 194.5"H x 2"D	51.5"W x 196.5"H x 22.75"D	View Online Template	9.75 lbs. / 15.25 lbs.	Super Poly Knit Fabric



Streamline Sabre Sail Sign

Description	Item #	Single-Sided Flag				Double-Sided Flag				
		1	2-5	6-11	12-24	Item #	1	2-5	6-11	12-24
9' Kit with Ground Spike	191444	202.00	196.00	186.00	180.00	191450	296.00	287.00	272.00	263.00
9' Kit with Scissor Base and Water Ballast	191445	268.00	260.00	247.00	239.00	191451	362.00	351.00	333.00	322.00
13' Kit with Ground Spike	191446	250.00	243.00	230.00	223.00	191452	383.00	372.00	352.00	341.00
13' Kit with Scissor Base and Water Ballast	191447	316.00	307.00	291.00	281.00	191453	449.00	436.00	413.00	400.00
17' Kit with Ground Spike	191448	308.00	299.00	283.00	274.00	191454	476.00	462.00	445.00	430.00
17' Kit with Scissor Base and Water Ballast	191449	374.00	363.00	344.00	333.00	191455	542.00	526.00	505.00	489.00

Kit Includes: Hardware with Specified Base, Flag and Soft Carry Case

USD MSRP (C)

Description	Product Size w/Ground Spike	Product Size w/Scissor Base	Finished Graphic Size	Product Wt. (Spike / Scissor)	Media
9'	29"W x 106"H x 2"D	40.5"W x 108"H x 22.75"D	View Online Template	4.25 lbs. / 10.25 lbs.	Super Poly Knit Fabric
13'	33.5"W x 151"H x 2"D	45"W x 153"H x 22.75"D	View Online Template	5.5 lbs. / 11.5 lbs.	Super Poly Knit Fabric
17'	37.5"W x 200"H x 2"D	49"W x 202"H x 22.75"D	View Online Template	6.75 lbs. / 12.75 lbs.	Super Poly Knit Fabric



Streamline Rectangle Sail Sign

Description	Item #	Single-Sided Flag				Double-Sided Flag				
		1	2-5	6-11	12-24	Item #	1	2-5	6-11	12-24
7' Kit with Ground Spike	191416	202.00	196.00	186.00	180.00	191422	296.00	287.00	272.00	263.00
7' Kit with Scissor Base and Water Ballast	191417	268.00	260.00	247.00	239.00	191423	362.00	351.00	333.00	322.00
10' Kit with Ground Spike	191418	250.00	243.00	230.00	223.00	191424	383.00	372.00	352.00	341.00
10' Kit with Scissor Base and Water Ballast	191419	316.00	307.00	291.00	281.00	191425	449.00	436.00	413.00	400.00
14.5' Kit with Ground Spike	191420	308.00	299.00	283.00	274.00	191426	476.00	462.00	445.00	430.00
14.5' Kit with Scissor Base and Water Ballast	191421	374.00	363.00	344.00	333.00	191427	542.00	526.00	505.00	489.00

Kit Includes: Hardware with Specified Base, Flag and Soft Carry Case

USD MSRP (C)

Description	Product Size w/Ground Spike	Product Size w/Scissor Base	Finished Graphic Size	Product Wt. (Spike / Scissor)	Media
7'	31.5"W x 85.5"H x 2"D	43"W x 87.5"H x 22.75"D	View Online Template	5 lbs. / 10.25 lbs.	Super Poly Knit Fabric
10'	31.5"W x 117"H x 2"D	43"W x 119"H x 22.75"D	View Online Template	6.25 lbs. / 11.75 lbs.	Super Poly Knit Fabric
14.5'	31.5"W x 171.5"H x 2"D	43"W x 173.5"H x 22.75"D	View Online Template	7.75 lbs. / 13.25 lbs.	Super Poly Knit Fabric



Setup fee: \$20.00(G); no setup fee on orders placed via our website; see page 224 for details.
View current graphic templates, assembly videos and instructions on our website.
See pages 224-226 for additional information that may apply to your order.

AFTER FINAL PROOF APPROVAL
PRODUCTION LEAD TIME IS
2DAYS

PREMIUM SAIL SIGN

Premium flags are reinforced with black pole pockets constructed of high tensile strength elastic polyester binding.

- Sizes range from 6' to 17' tall
- New Blade shape now available
- Carbon composite poles are strong and flexible
- Artwork is dye sublimated on super poly knit fabric
- Flags used outdoors have a 90-day warranty; flags used indoors have a 1-year warranty
- Lifetime warranty on pole hardware
- Quick Ship options available (see page 94)



Suggested Uses:
Trade Shows
Outdoor Branding
Product Launches
Sales Events



**NEW
SHAPE**



Straight bottom edge on blade sail signs increase the usable graphic area for even bigger, bolder design possibilities.

7' Blade 10' Rectangle 13' Sabre 15' Teardrop 14.5' Rectangle 13' Razor 9' Sabre 6' Teardrop

Single- or Double-Sided



Single-Sided
Reverse image shows through back.



Double-Sided
Image on both sides with a block-out liner in between.

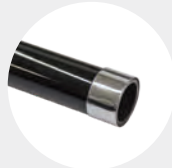

Uniform carbon composite overlay construction with high-gloss black paint finish.



Flag attaches to a fixed hook using a bungee cord.

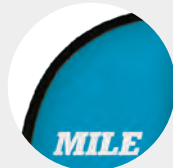

Pole pocket is made of high tensile strength elastic polyester binding.

Premium Blade Sail Sign

Description	Item #	Single-Sided Flag				Double-Sided Flag				
		1	2-5	6-11	12-24	Item #	1	2-5	6-11	12-24
7' Kit with Ground Spike	191515	205.00	199.00	189.00	182.00	191517	311.00	302.00	286.00	277.00
7' Kit with Three-Legged Base and Water Ballast	191516	238.00	231.00	219.00	212.00	191518	343.00	333.00	316.00	305.00
9' Kit with Ground Spike	191521	227.00	220.00	209.00	202.00	191523	346.00	336.00	318.00	308.00
9' Kit with Scissor Base and Water Ballast	191522	293.00	284.00	270.00	261.00	191524	412.00	400.00	379.00	367.00
13' Kit with Ground Spike	191527	249.00	239.00	226.00	216.00	191529	379.00	362.00	343.00	327.00
13' Kit with Scissor Base and Water Ballast	191528	315.00	303.00	287.00	275.00	191530	445.00	426.00	404.00	386.00
17' Kit with Ground Spike	191533	330.00	320.00	304.00	294.00	191535	524.00	508.00	490.00	474.00
17' Kit with Scissor Base and Water Ballast	191534	396.00	384.00	364.00	352.00	191536	590.00	572.00	550.00	533.00

Kit Includes: Hardware with Specified Base, Flag and Soft Carry Case

Description	Product Size w/Ground Spike	Product Size w/Scissor Base	Finished Graphic Size	Product Wt. (Spike / Scissor)	Media
7'	19.75"W x 81.5"H x 2"D	28.375"W x 83.5"H x 15.25"D	View Online Template	3.25 lbs. / 3 lbs.	Super Poly Knit Fabric
9'	29"W x 106"H x 2"D	40.5"W x 108"H x 23"D	View Online Template	10 lbs. / 10.5 lbs.	Super Poly Knit Fabric
13'	32"W x 151"H x 2"D	43.5"W x 153"H x 23"D	View Online Template	11 lbs. / 12.5 lbs.	Super Poly Knit Fabric
17'	36"W x 205"H x 2"D	47.5"W x 207"H x 23"D	View Online Template	12.5 lbs. / 14.5 lbs.	Super Poly Knit Fabric



NEW SHAPE

BANNERS & FLAGS

Premium Razor Sail Sign

Description	Item #	Single-Sided Flag				Double-Sided Flag				
		1	2-5	6-11	12-24	Item #	1	2-5	6-11	12-24
7' Kit with Ground Spike	190982	205.00	199.00	189.00	182.00	190980	313.00	304.00	288.00	279.00
7' Kit with Three-Legged Base and Water Ballast	190985	238.00	231.00	219.00	212.00	190984	345.00	335.00	317.00	307.00
9' Kit with Ground Spike	190667	228.00	221.00	210.00	203.00	190665	347.00	337.00	319.00	309.00
9' Kit with Scissor Base and Water Ballast	190757	294.00	285.00	270.00	262.00	190756	413.00	401.00	380.00	368.00
13' Kit with Ground Spike	190672	277.00	269.00	255.00	247.00	190670	437.00	424.00	408.00	395.00
13' Kit with Scissor Base and Water Ballast	190759	343.00	333.00	316.00	305.00	190758	503.00	488.00	469.00	454.00
17' Kit with Ground Spike	190677	332.00	322.00	309.00	299.00	190675	527.00	511.00	493.00	477.00
17' Kit with Scissor Base and Water Ballast	190761	398.00	386.00	370.00	358.00	190760	593.00	575.00	553.00	535.00

Kit Includes: Hardware with Specified Base, Flag and Soft Carry Case

Description	Product Size w/Ground Spike	Product Size w/Scissor Base	Finished Graphic Size	Product Wt. (Spike / Scissor)	Media
7'	19.75"W x 81.5"H x 2"D	28.375"W x 83.5"H x 15.25"D	View Online Template	3.25 lbs. / 3 lbs.	Super Poly Knit Fabric
9'	29"W x 106"H x 2"D	40.5"W x 108"H x 22.75"D	View Online Template	5 lbs. / 10.5 lbs.	Super Poly Knit Fabric
13'	32"W x 151"H x 2"D	43.5"W x 153"H x 22.75"D	View Online Template	7 lbs. / 12.5 lbs.	Super Poly Knit Fabric
17'	36"W x 205"H x 2"D	47.5"W x 207"H x 22.75"D	View Online Template	9 lbs. / 14.5 lbs.	Super Poly Knit Fabric



Premium Teardrop Sail Sign

Description	Item #	Single-Sided Flag				Double-Sided Flag				
		1	2-5	6-11	12-24	Item #	1	2-5	6-11	12-24
6' Kit with Ground Spike	190976	205.00	199.00	189.00	182.00	190974	313.00	304.00	288.00	279.00
6' Kit with Three-Legged Base and Water Ballast	190979	238.00	231.00	219.00	212.00	190978	345.00	335.00	317.00	307.00
8' Kit with Ground Spike	190682	228.00	221.00	210.00	203.00	190680	347.00	337.00	319.00	309.00
8' Kit with Scissor Base and Water Ballast	190763	294.00	285.00	270.00	262.00	190762	413.00	401.00	380.00	368.00
11.5' Kit with Ground Spike	190687	277.00	269.00	255.00	247.00	190685	437.00	424.00	408.00	395.00
11.5' Kit with Scissor Base and Water Ballast	190765	343.00	333.00	316.00	305.00	190764	503.00	488.00	469.00	454.00
15' Kit with Ground Spike	190692	332.00	322.00	309.00	299.00	190690	527.00	511.00	493.00	477.00
15' Kit with Scissor Base and Water Ballast	190767	398.00	386.00	370.00	358.00	190766	593.00	575.00	553.00	535.00

Kit Includes: Hardware with Specified Base, Flag and Soft Carry Case

Description	Product Size w/Ground Spike	Product Size w/Scissor Base	Finished Graphic Size	Product Wt. (Spike / Scissor)	Media
6'	23.25"W x 72.5"H x 2"D	31.875"W x 74.5"H x 15.25"D	View Online Template	3 lbs. / 2.75 lbs.	Super Poly Knit Fabric
8'	30.5"W x 91.5"H x 2"D	42"W x 93.5"H x 22.75"D	View Online Template	5 lbs. / 10.5 lbs.	Super Poly Knit Fabric
11.5'	36"W x 144.5"H x 2"D	47.5"W x 146.5"H x 22.75"D	View Online Template	7.5 lbs. / 13 lbs.	Super Poly Knit Fabric
15'	40"W x 194.5"H x 2"D	51.5"W x 196.5"H x 22.75"D	View Online Template	10 lbs. / 15.5 lbs.	Super Poly Knit Fabric



Premium Sabre Sail Sign

Description	Item #	Single-Sided Flag				Double-Sided Flag				
		1	2-5	6-11	12-24	Item #	1	2-5	6-11	12-24
9' Kit with Ground Spike	190952	228.00	221.00	210.00	203.00	190950	347.00	337.00	319.00	309.00
9' Kit with Scissor Base and Water Ballast	190955	294.00	285.00	270.00	262.00	190954	413.00	401.00	380.00	368.00
13' Kit with Ground Spike	190958	277.00	269.00	255.00	247.00	190956	437.00	424.00	408.00	395.00
13' Kit with Scissor Base and Water Ballast	190961	343.00	333.00	316.00	305.00	190960	503.00	488.00	469.00	454.00
17' Kit with Ground Spike	190964	332.00	322.00	309.00	299.00	190962	527.00	511.00	493.00	477.00
17' Kit with Scissor Base and Water Ballast	190967	398.00	386.00	370.00	358.00	190966	593.00	575.00	553.00	535.00

Kit Includes: Hardware with Specified Base, Flag and Soft Carry Case

Description	Product Size w/Ground Spike	Product Size w/Scissor Base	Finished Graphic Size	Product Wt. (Spike / Scissor)	Media
9'	29"W x 106"H x 2"D	40.5"W x 108"H x 22.75"D	View Online Template	5 lbs. / 11 lbs.	Super Poly Knit Fabric
13'	33.5"W x 151"H x 2"D	45"W x 153"H x 22.75"D	View Online Template	6.25 lbs. / 12.25 lbs.	Super Poly Knit Fabric
17'	37.5"W x 200"H x 2"D	49"W x 202"H x 22.75"D	View Online Template	8.5 lbs. / 14.5 lbs.	Super Poly Knit Fabric



Premium Rectangle Sail Sign

Description	Item #	Single-Sided Flag				Double-Sided Flag				
		1	2-5	6-11	12-24	Item #	1	2-5	6-11	12-24
7' Kit with Ground Spike	190652	228.00	221.00	210.00	203.00	190650	347.00	337.00	319.00	309.00
7' Kit with Scissor Base and Water Ballast	190751	294.00	285.00	270.00	262.00	190750	413.00	401.00	380.00	368.00
10' Kit with Ground Spike	190657	277.00	269.00	255.00	247.00	190655	437.00	424.00	408.00	395.00
10' Kit with Scissor Base and Water Ballast	190753	343.00	333.00	316.00	305.00	190752	503.00	488.00	469.00	454.00
14.5' Kit with Ground Spike	190662	332.00	322.00	309.00	299.00	190660	527.00	511.00	493.00	477.00
14.5' Kit with Scissor Base and Water Ballast	190755	398.00	386.00	370.00	358.00	190754	593.00	575.00	553.00	535.00

Kit Includes: Hardware with Specified Base, Flag and Soft Carry Case

Description	Product Size w/Ground Spike	Product Size w/Scissor Base	Finished Graphic Size	Product Wt. (Spike / Scissor)	Media
7'	31.5"W x 85.5"H x 2"D	43"W x 87.5"H x 22.75"D	View Online Template	5.25 lbs. / 10.5 lbs.	Super Poly Knit Fabric
10'	31.5"W x 117"H x 2"D	43"W x 119"H x 22.75"D	View Online Template	6.5 lbs. / 12 lbs.	Super Poly Knit Fabric
14.5'	31.5"W x 171.5"H x 2"D	43"W x 173.5"H x 22.75"D	View Online Template	8 lbs. / 13.5 lbs.	Super Poly Knit Fabric



Setup fee: \$20.00(G); no setup fee on orders placed via our website; see page 224 for details. View current graphic templates, assembly videos and instructions on our website. See pages 224-226 for additional information that may apply to your order.

AFTER FINAL PROOF APPROVAL
PRODUCTION LEAD TIME IS
4 DAYS

NEW & IMPROVED



9' Razor with scissor base



13' Razor with scissor base



17' Razor with scissor base

QUICK SHIP 24-HOUR QUICK SHIP PREMIUM SAIL SIGN

Our popular Razor sail signs can be printed and on their way in just 24 hours.

- Available in Razor 9', 13' and 17' sizes
- Now offering a larger print area for even more ad space
- Lifetime warranty on pole hardware
- See page 226 for Quick Ship specifications and ordering info
- See pages 92-93 for product details



24-Hour Quick Ship Premium Razor Sail Sign

Description	Item #	Ground Spike		Scissor Base		
		1	2-5	Item #	1	2-5
9' Single-Sided	190793	480.00	401.00	190790	543.00	453.00
13' Single-Sided	190794	522.00	436.00	190791	585.00	488.00
17' Single-Sided	190795	564.00	471.00	190792	627.00	524.00

USD MSRP (C)



Flags are printed single-sided; reverse image shows through the back.

QUICK SHIP 48-HOUR QUICK SHIP PREMIUM SAIL SIGN

These high-quality, full-color sail signs leave our warehouse within 48 hours.

- Available in three shapes and several sizes
- Lifetime warranty on pole hardware
- See page 226 for Quick Ship specifications and ordering info
- See pages 92-93 for product details



48-Hour Quick Ship Premium Teardrop Sail Sign

Description	Item #	Ground Spike		Scissor Base		
		1	2-5	Item #	1	2-5
8' Single-Sided	190822	462.00	366.00	190802	524.00	429.00
8' Double-Sided	190831	575.00	483.00	190811	640.00	545.00
11.5' Single-Sided	190825	503.00	409.00	190805	565.00	473.00
11.5' Double-Sided	190834	585.00	493.00	190814	650.00	555.00
15' Single-Sided	190828	544.00	437.00	190808	606.00	504.00
15' Double-Sided	190837	606.00	514.00	190817	680.00	585.00

USD MSRP (C)

48-Hour Quick Ship Premium Razor Sail Sign

Description	Item #	Ground Spike		Scissor Base		
		1	2-5	Item #	1	2-5
9' Single-Sided	190821	462.00	366.00	190801	524.00	429.00
9' Double-Sided	190830	575.00	483.00	190810	640.00	545.00
13' Single-Sided	190824	503.00	408.00	190804	565.00	473.00
13' Double-Sided	190833	585.00	493.00	190813	650.00	555.00
17' Single-Sided	190827	544.00	437.00	190807	606.00	504.00
17' Double-Sided	190836	606.00	514.00	190816	680.00	585.00

USD MSRP (C)

48-Hour Quick Ship Premium Rectangle Sail Sign

Description	Item #	Ground Spike		Scissor Base		
		1	2-5	Item #	1	2-5
7' Single-Sided	190820	462.00	366.00	190800	524.00	429.00
7' Double-Sided	190829	575.00	485.00	190809	640.00	545.00
10' Single-Sided	190823	503.00	409.00	190803	565.00	473.00
10' Double-Sided	190832	585.00	493.00	190812	650.00	555.00
14.5' Single-Sided	190826	544.00	437.00	190806	606.00	506.00
14.5' Double-Sided	190835	606.00	514.00	190815	680.00	585.00

USD MSRP (C)



8' Teardrop with scissor base



11.5' Teardrop with scissor base



15' Teardrop with scissor base



SOLID COLOR SAIL SIGN

These stock color sail signs are vibrantly dyed on nylon to make your display pop.

- Features a single stock color across the entire flag, including the pole pocket
- 26 color options to choose from
- Sail sign and pole pocket are constructed of 200 denier nylon
- Available in the new Blade shape
- Choose Value or Streamline sail sign option (see pages 88-89 or 90-91 for product details)
- Flags used outdoors have a 90-day warranty; flags used indoors have a 1-year warranty



Solid Color Blade Sail Sign

Item #	Description	1	2-5	6-11	12-24
191548	10.5' Value Kit with Spike Base*	106.00	103.00	98.00	94.00
191549	10.5' Value Kit with Cross Base and Water Ballast*	150.00	146.00	138.00	134.00
191545	13' Streamline Kit with Spike Base	175.00	115.00	110.00	106.00
191546	13' Streamline Kit with Scissor Base and Water Ballast	241.00	179.00	170.00	165.00

Kit Includes: Hardware with Specified Base, Flag and Soft Carry Case USD MSRP (C)
 *Value kits do not include carry case.

Description	Product Size w/Ground Spike	Product Size w/Scissor Base	Product Wt. (Spike / Scissor)	Media
Value	30.25"W x 124"H x 1.5"D	45.25"W x 127.375"H x 23.75"D	3 lbs. / 4.3 lbs.	Nylon
Streamline	32"W x 151"H x 2"D	43.5"W x 153"H x 23"D	5.75 lbs. / 6.75 lbs.	Nylon

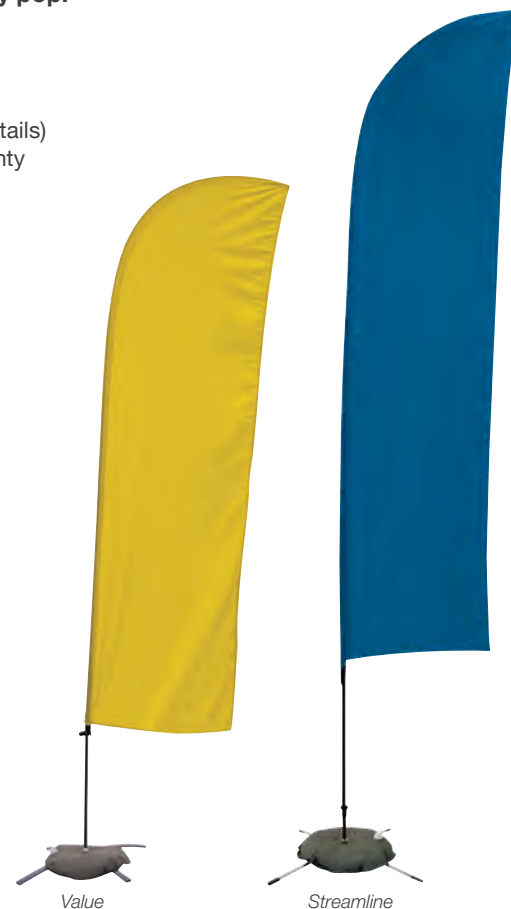

Stock Sail Sign Colors

Bell Blue PMS 641	French Blue PMS 285	Pansy PMS 2617
Black	Gray PMS 7538	Purple PMS 2695
Buff PMS 141	Irish Green PMS 349	Royal Blue PMS 286
Canada Red PMS 186	Legion Blue PMS 2756	Silver PMS 7534
Charcoal PMS 424	Maroon PMS 5115	Spice Brown PMS 1545
Daffodil PMS 108	Mint Green PMS 360	Spanish Yellow PMS 1235
Dartmouth PMS 350	OG Blue PMS 2768	UN Blue PMS 279
Emerald 3425	OG Red PMS 187	White
FM Yellow PMS 106	Orange PMS 172	

PMS colors are for reference only and may vary slightly from actual color.

Setup fee: \$20.00(G); no setup fee on orders placed via our website; see page 224 for details.
 View current graphic templates, assembly videos and instructions on our website.
 See pages 224-226 for additional information that may apply to your order.

AFTER FINAL PROOF APPROVAL
 PRODUCTION LEAD TIME IS
4 DAYS

Suggested Uses:
Leasing Buildings
Sporting Events
Restaurants
Festivals



STADIUM FLUTTER FLAG

These flags are designed to flutter in the breeze.

- The stadium shape has rounded corners for a contoured look
- Great flyability, even in the slightest breeze
- Available in 10', 15' and 18' sizes
- Flag and pole pocket are constructed of super poly knit fabric
- Flags used outdoors have a 90-day warranty; flags used indoors have a 1-year warranty



Stadium Flutter Flag

Item #	Description	1	2-5	6-11	12-24
304866	10' Single-Sided Kit	208.00	198.00	187.00	177.00
304867	10' Double-Sided Kit	308.00	293.00	277.00	262.00
304868	15' Single-Sided Kit	258.00	245.00	232.00	219.00
304869	15' Double-Sided Kit	398.00	378.00	358.00	338.00
304870	18' Single-Sided Kit	308.00	293.00	277.00	262.00
304871	18' Double-Sided Kit	488.00	464.00	439.00	415.00

Kit Includes: Hardware with Spike Base, Flag and Soft Carry Case USD MSRP (C)

Description	Product Size	Finished Graphic Size	Product Wt.	Media
10'	30"W x 120"H x 2"D	View Online Template	6.2 lbs.	Super Poly Knit Fabric
15'	30"W x 178.75"H x 2"D	View Online Template	8.5 lbs.	Super Poly Knit Fabric
18'	30"W x 218.5"H x 2"D	View Online Template	10 lbs.	Super Poly Knit Fabric

Single- or Double-Sided



Single-Sided

Reverse image shows through back.



Double-Sided

Image on both sides with a block-out liner in between.

Durable Construction



Carbon composite overlay construction with high-gloss black paint finish.

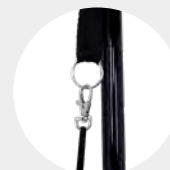

Flag attaches to a fixed hook using a bungee cord.

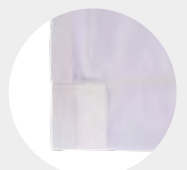

Pole pocket is made of the same fabric as the flag.

AFTER FINAL PROOF APPROVAL
PRODUCTION LEAD TIME IS
4 DAYS

Setup fee: \$20.00(G); no setup fee on orders placed via our website; see page 224 for details.
View current graphic templates, assembly videos and instructions on our website.
See pages 224-226 for additional information that may apply to your order.

SOLID COLOR FLUTTER FLAG

The combination of movement and vibrant stock colors are an economical way to draw attention in any environment.

- Flag and pole pocket are constructed of 200 denier nylon
- Stock colors pair well with any color scheme or logo, so they work well on their own or with branded promotional displays
- 26 color options to choose from
- The stadium shape has rounded corners for a contoured look
- Flags used outdoors have a 90-day warranty; flags used indoors have a 1-year warranty



Solid Color Flutter Flag

Item #	Description	1	2-5	6-11	12-24
304780	10' Kit	148.00	141.00	133.00	126.00
304781	15' Kit	174.00	165.00	157.00	148.00
304782	18' Kit	196.00	186.00	176.00	167.00

Kit Includes: Hardware with Spike Base, Flag and Soft Carry Case USD MSRP (C)

Description	Product Size	Product Wt.	Media
10'	30"W x 120"H x 2"D	3.7 lbs.	Nylon
15'	30"W x 178.75"H x 2"D	5.5 lbs.	Nylon
18'	30"W x 218.5"H x 2"D	6.6 lbs.	Nylon

Stock Flag Colors

	Bell Blue PMS 641		French Blue PMS 285		Pansy PMS 2617
	Black		Gray PMS 7538		Purple PMS 2695
	Buff PMS 141		Irish Green PMS 349		Royal Blue PMS 286
	Canada Red PMS 186		Legion Blue PMS 2756		Silver PMS 7534
	Charcoal PMS 424		Maroon PMS 5115		Spice Brown PMS 1545
	Daffodil PMS 108		Mint Green PMS 360		Spanish Yellow PMS 1235
	Dartmouth PMS 350		OG Blue PMS 2768		UN Blue PMS 279
	Emerald 3425		OG Red PMS 187		White
	FM Yellow PMS 106		Orange PMS 172		

PMS colors are for reference only and may vary slightly from actual color.



MESSAGE FLUTTER FLAG

These timeless messages are made to flutter in the breeze. Choose from our stock message options or write your own.

- Flag and pole pocket are both constructed of 200 denier nylon
- Features red, white and blue sewn stripes with your custom message or a stock message printed on the white stripe in black letters
- 15 stock messages available
- Custom option lets you choose your message; 35 character maximum
- The stadium shape has rounded corners for a contoured look
- Flags used outdoors have a 90-day warranty; flags used indoors have a 1-year warranty



Message Flutter Flag

Item #	Description	1	2-5	6-11	12-24
304784	15' Stock Message Kit	187.00	178.00	168.00	159.00
304787	15' Custom Message Kit	198.00	188.00	178.00	168.00

Kit Includes: Hardware with Spike Base, Flag and Soft Carry Case USD MSRP (C)

Description	Product Size	Finished Graphic Size	Product Wt.	Media
15'	30"W x 178.75"H x 2"D	View Online Template	5.5 lbs.	Nylon

Stock Message Options

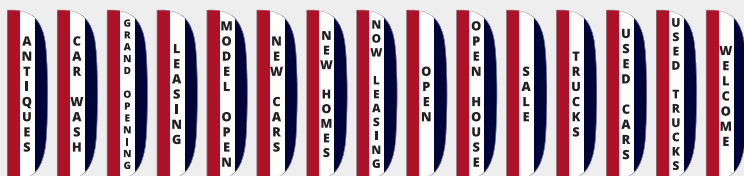

Setup fee: \$20.00(G); no setup fee on orders placed via our website; see page 224 for details. View current graphic templates, assembly videos and instructions on our website. See pages 224-226 for additional information that may apply to your order.

AFTER FINAL PROOF APPROVAL
PRODUCTION LEAD TIME IS
4 DAYS



Shown with Value cross base (sold separately)



Bottom of the Ballast Block is grooved so the base fits neatly underneath.



Shown with Premium sail sign (sold separately, see pages 92-93)

SAIL SIGN BALLAST BLOCK

Function meets form in this hefty combo. The ballast block keeps your sail sign stable while the skirt lets you add full-color artwork.

- Compatible with scissor and cross bases (sold separately) when used on flat, hard surfaces
- Ballast block is constructed of high-grade nylon polymer
- Ballast block holds 4.75 gallons of water (weighs 40 lbs. when filled with water)
- Skirt is made of the same durable 400 denier polyester we use for our tent canopies
- Sail sign sold separately



Sail Sign Ballast Block

Item #	Description	1	2-5	6-11	12-24
190740	Kit	156.10	151.40	143.60	138.90
190741	Hardware Only	83.20	80.70	76.50	74.00
Kit Includes: Ballast and Skirt		USD MSRP (C)			
Product Size 22"W x 5"H x 22.375"D		Finished Graphic Size View Online Template		Product Wt. 6 lbs.	Media 400 Denier Polyester

SAIL SIGN MOTORIZED SPINNER BASE

This automated base slowly rotates to bring attention to your sail sign.

- Kit includes topper constructed of 4 mm corrugated plastic, which can be customized with a full-color digital print
- Sturdy steel base plate with high-gloss black enamel finish
- Smooth, quiet operation
- Six rotations per minute (RPM)
- Indoor use only
- Compatible with sail signs up to 10.5' tall
- Sail sign sold separately



Sail Sign Motorized Spinner Base

Item #	Description	1	2-5	6-11	12-24
191566	Kit	155.30	147.80	139.40	131.90
191567	Hardware Only	147.00	140.00	132.00	125.00
Kit Includes: Base and Topper		USD MSRP (C)			
Product Size 17.75"W x 7.125"H x 17.75"D		Finished Graphic Size View Online Template		Product Wt. 13.25 lbs.	Media 4 mm Corrugated Plastic

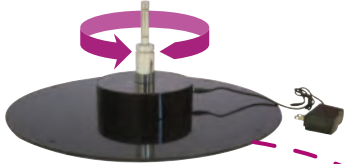

Base with plug-in cord



Threaded metal spindle twists onto the base.



Shown with Premium sail sign (sold separately, see pages 92-93)

SAIL SIGN TRI-POST BASE

This hardworking base can hold three sail signs at once.

- Kit includes topper constructed of 4 mm corrugated plastic, which can be customized with a full-color digital print
- Heavy-duty base is constructed of steel
- Can be used with sail signs up to 13' in height
- Flags are angled outward at a 10° angle
- Hex wrench included
- Sail signs sold separately



Sail Sign Tri-Post Base

Item #	Description	1	2-5	6-11	12-24
191592	Kit	85.00	82.00	78.00	76.00
191593	Hardware Only	77.00	75.00	71.00	69.00
Kit Includes: Base and Topper		USD MSRP (C)			
Product Size 17.75"W x 7.25"H x 17.75"D		Finished Graphic Size 17.625"W x 17.625"D		Product Wt. 11.5 lbs.	Media 4 mm Corrugated Plastic



Base without topper

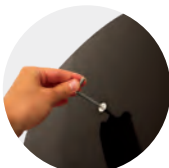

Post attaches to the base using a hex-socket bolt.



Shown with three Streamline sail signs (sold separately, see pages 90-91)

SPINNER W/TOPPER & TRI-POST | BALLAST W/ SKIRT
3 OR 4 DAYS
 AFTER FINAL PROOF APPROVAL
 PRODUCTION LEAD TIME IS

HARDWARE ONLY LEAD TIME: SHIPS SAME DAY WHEN ORDERED BEFORE 2 PM CENTRAL
 Setup fee: \$20.00(G); no setup fee on orders placed via our website; see page 224 for details.
 View current graphic templates, assembly videos and instructions on our website.
 See pages 224-226 for additional information that may apply to your order.



NEW PRODUCT

NEW PRODUCT

NEW PRODUCT

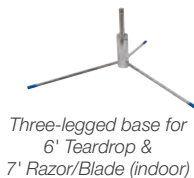

NEW PRODUCT



SAIL SIGN & FLUTTER FLAG ACCESSORIES



Sail Sign & Flutter Flag Accessories

Item #	Description	Product Wt.	1	2-5	6-11	12-24
190711	Heavy-Duty Cross Base	9 lbs.	76.00	73.70	69.90	67.60
190709	Vehicle Base	4.5 lbs.	65.70	63.70	60.40	58.50
190707	Scissor Base	7 lbs.	65.70	63.70	60.40	58.50
190706	Ground Spike	2 lbs.	43.10	41.80	39.70	38.40
190714	3-Legged Base	1.25 lbs.	32.10	31.10	29.50	28.60
191591	Value Cross Base*	2.8 lbs.	31.60	30.70	29.10	28.10
191590	Value Spike*	2 lbs.	31.60	30.70	29.10	28.10
190708	Round Water Ballast	0.5 lb.	43.50	42.20	40.00	38.70
190710	Square Water Ballast	0.5 lb.	43.50	42.20	40.00	38.70
220082	Universal Product Case	7 lbs.	124.00	120.00	117.00	115.00
240521	Mount for Standard Tents	2 lbs.	34.40	33.30	31.70	30.60
240522	Mount for Deluxe Tents	2 lbs.	37.50	36.40	34.50	33.40
240523	Mount for Premium Aluminum Tents	2 lbs.	60.80	59.90	56.90	56.00
190699	Mount for Fence Posts	1.4 lbs.	35.00	34.00	32.20	31.20
190746	Flat Base	21.8 lbs.	120.00	114.00	108.00	102.00
190743	Wall Mount Hardware	1.6 lbs.	34.00	32.30	30.60	28.90
190744	Floor Mount Hardware	1.4 lbs.	34.00	32.30	30.60	28.90
190747	Simple Spike*	1.4 lbs.	20.00	19.00	18.00	17.00

*Covered by a 90-day product warranty

USD MSRP (C)



View current instructions on our website.
See pages 224-226 for additional information that may apply to your order.

**HARDWARE SHIPS
SAME DAY**
WHEN ORDERED BEFORE 2PM CENTRAL

Suggested Uses:
 Grocery Stores
 Shopping Malls
 Car Dealerships
 Print Shops



Magnet

Suction Cup

Clip-On

Vehicle

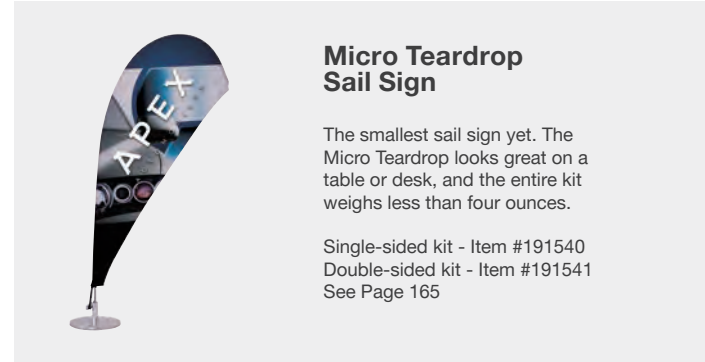

Micro Teardrop Sail Sign

The smallest sail sign yet. The Micro Teardrop looks great on a table or desk, and the entire kit weighs less than four ounces.

Single-sided kit - Item #191540
 Double-sided kit - Item #191541
 See Page 165

MINI SAIL SIGN

This small, versatile flag is a creative option for advertising or showing off team spirit.

- Four hardware attachment styles available
- Hardware-only options available online, allowing you to change out the attachment style
- Artwork is dye sublimated on super poly knit fabric
- Minimum quantity of three
- Flags used outdoors have a 90-day warranty; flags used indoors have a 1-year warranty



Mini Teardrop Sail Sign

Item #	Description	3-5	6-11	12-24	25-49
191380	Vehicle Single-Sided Kit	35.30	34.30	33.60	32.50
191381	Vehicle Double-Sided Kit	60.20	58.70	57.50	55.60
191382	Clip-On Single-Sided Kit	34.25	33.30	32.60	31.50
191383	Clip-On Double-Sided Kit	59.15	57.70	56.50	54.60
191384	Suction Cup Single-Sided Kit	38.40	37.20	36.50	35.20
191385	Suction Cup Double-Sided Kit	63.30	61.60	60.40	58.30
191391	Magnet Single-Sided Kit	40.50	39.20	38.40	37.10
191392	Magnet Double-Sided Kit	65.40	63.60	62.30	60.20
191389	Single-Sided Flag Only	24.90	24.40	23.90	23.20
191390	Double-Sided Flag Only	49.80	48.80	47.80	46.30
Kit Includes: Hardware and Flag				USD MSRP (C)	

Description	Product Size	Finished Graphic Size	Product Wt.	Media
Mini Vehicle	15.5"W x 25.875"H x 2.875"D	View Online Template	4.1 oz.	Super Poly Knit Fabric
Mini Clip-On	15.5"W x 26"H x 1.875"D	View Online Template	3.3 oz.	Super Poly Knit Fabric
Mini Suction Cup	17"W x 23.5"H x 3.5"D	View Online Template	5.1 oz.	Super Poly Knit Fabric
Mini Magnet	14.25"W x 24.75"H x 2.75"D	View Online Template	8 oz.	Super Poly Knit Fabric



Magnet
 Securely mounts on any steel surface. Rubber base prevents scratching. (Not intended for use on vehicles in motion.)



Suction Cup
 Attaches to most nonporous surfaces like store windows.

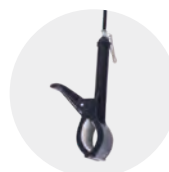

Clip-On
 Can be used for just about anything, including sale-aisle promotion and warehouse labeling.



Vehicle
 Slides onto your vehicle window. (Not intended for use on vehicles in motion.)

4 DAYS
AFTER FINAL PROOF APPROVAL
 PRODUCTION LEAD TIME IS

Setup fee: \$20.00(G); no setup fee on orders placed via our website; see page 224 for details.
 View current graphic templates, assembly videos and instructions on our website.
 See pages 224-226 for additional information that may apply to your order.



GIANT OUTDOOR FLAG

Capture attention, even from a distance. Our largest outdoor display adjusts up to 17' high.

- Pole adjusts to three positions
- Top banner arm pivots in the wind
- Artwork is dye sublimated on super poly knit fabric
- Four-piece ballast base holds the display in place
- Signboard add-on (sold separately) adds messaging space to the base of the flagpole
- Flags used outdoors have a 90-day warranty; flags used indoors have a 1-year warranty



Giant Outdoor Flag

Item #	Description	1	2-5	6-11	12-24
190371	Single-Sided Kit	585.00	575.00	560.00	550.00
190374	Double-Sided Kit	700.00	690.00	685.00	670.00

Kit Includes: Hardware, Flag and 2 Carry Cases USD MSRP (C)

Ballast Signboard Kit

Item #	Description	1	2-5	6-11	12-24
190397	Single-Sided Kit	83.20	78.80	73.20	68.80

Kit Includes: 4 Single-Sided Signboards USD MSRP (C)

Description	Product Size	Finished Graphic Size	Product Wt. (Single / Double)	Media
Giant Outdoor Flag	57"W x 212.5"H x 31"D	41"W x 120"H	31.75 lbs. / 33.75 lbs.	Super Poly Knit Fabric
Ballast Signboard	21"W x 39"H	21"W x 39"H	2 lbs. / NA	4 mm Corrugated Plastic

Wind Test Assessment: Giant Outdoor Flag withstands winds up to 25 mph with full water ballasts.

Disclaimer: Wind rating conducted in a controlled environment. Outdoor products should be taken down if bad weather is likely. Wind gusts and heavy rain could reduce the wind resistance of these products.



Giant Outdoor Flag with Ballast Signboard Kit (sold separately)



Adjust the height from 10' to 17' with the push-button telescoping pole.



The flag's grommets attach to clip rings on the pole to make graphic changes quick and easy.



Base sections can be filled with water or sand for stability.



Ballast signboards (sold separately) attach to clips on the support legs.

Setup fee: \$20.00(G); no setup fee on orders placed via our website; see page 224 for details. View current graphic templates, assembly videos and instructions on our website. See pages 224-226 for additional information that may apply to your order.

AFTER FINAL PROOF APPROVAL
PRODUCTION LEAD TIME IS
4 DAYS



1. Deluxe 10' Tent with Full Wall page 105 & 115 | 2. Modular Event Counter page 117

TENTS

When choosing a tent **have you considered...**

- **LOCATION** - Where will this tent be used?
- **LONGEVITY** - Will you be using your tent for one or multiple events?
- **MESSAGE** - What is the desired impact of your promotional message?
- **WEATHER** - Will you need additional reinforcement against wind?
- **ACCESSORIES** - Would you like to add additional ad space?

TENT COMPARISON CHART

★ = Best Sellers	PG	FRAME/CANOPY WARRANTY	CONSTRUCTION		FRAME WEIGHT (LBS.)	TOTAL SIZE	QUICK SHIP OPTIONS	STOCK CANOPY COLORS		
10' TENTS - MOST POPULAR SIZE	10' Standard ★	104	1 Year / 1 Year	Steel 1.125" Legs		1 mm Powder-Coated Steel Plastic Push Button for Height Adjustments ABS Nylon Joints	36	118.5"W x 127.5"-140"H x 118.5"D		
	10' Deluxe	105	2 Years / 1 Year	Steel 1.25" Legs		1 mm Powder-Coated Steel Lever for Height Adjustments ABS Glass-Filled Nylon Joints	48	118.5"W x 127"-139.5"H x 118.5"D		
	10' Premium ★	106	5 Years / 1 Year	Aluminum 1.75" Dia. Hexagon Legs		0.8 mm Anodized Aluminum Lever for Height Adjustments ABS Glass-Filled Nylon Joints	36.5	118"W x 126.75"-139.25"H x 118"D		
	NEW! 10' Elite	107	Lifetime / 1 Year	Aluminum 2.125" Dia. Hexagon Legs		50 mm Anodized Aluminum Lever for Height Adjustments Machined Aluminum Joints	63	118"W x 116.75"-128.25"H x 118"D		
	10' Compact	108	1 Year / 1 Year	Aluminum 1.25" Legs		1 mm Anodized Aluminum Lever for Height Adjustments ABS Glass-Filled Nylon Joints	38.4	118.5"W x 121"-133.5"H x 118.5"D		
	NEW! 10' Premium Gable	112	5 Years / 1 Year	Aluminum 1.75" Dia. Hexagon Legs		0.8 mm Anodized Aluminum Lever for Height Adjustments ABS Glass-Filled Nylon Joints	37.4	118"W x 119.25"-131.75"H x 118"D		
6' Deluxe	110	2 Years / 1 Year	Steel 1.25" Legs		1 mm Powder-Coated Steel Lever for Height Adjustments ABS Glass-Filled Nylon Joints	38.5	72"W x 109"-121.5"H x 72"D			
8' Deluxe						44.5	96"W x 117.5"-130"H x 96"D			
15' Premium	111	5 Years / 1 Year	Aluminum 1.75" Dia. Hexagon Legs		0.8 mm Anodized Aluminum Lever for Height Adjustments ABS Glass-Filled Nylon Joints	46	175.5"W x 126.75"-139.25"H x 118.25"D			
20' Premium						62.75	234.5"W x 126.75"-139.25"H x 118.25"D			
NEW! 15' Premium Gable	112	5 Years / 1 Year	Aluminum 1.75" Dia. Hexagon Legs		0.8 mm Anodized Aluminum Lever for Height Adjustments ABS Glass-Filled Nylon Joints	47.2	175.5"W x 119.25"-131.75"H x 118.25"D			
NEW! 20' Premium Gable						64	234.5"W x 119.25"-131.75"H x 118.25"D			

Wind Test Assessment - All of our tents are rated to withstand winds up to 25 mph. We recommend ground stakes with rope and two steel ballasts or one water weight per leg.

Disclaimer: Wind rating conducted in a controlled environment. Outdoor products should be taken down if bad weather is likely. Wind gusts and heavy rain could reduce the wind resistance of these products.

TENT CANOPY



Canopies covered by a one-year warranty.

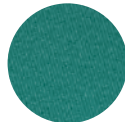

Constructed of durable 400 denier polyester.



50+ UV protection and weather-resistant.



Flame retardant treated (FR rated for exhibit halls).

10' Stock Canopy Colors



PMS colors are for reference only and may vary slightly from actual color.

Two Print Methods



Full-Color Imprint

Imprinted on peak and valance locations of your choice. One imprint per location (peak or valance). Only one setup fee per tent.

Dye Sublimation

Covers the entire canopy with vibrant, full-color artwork.*

*Not available on vented canopies

QUICK & EASY SETUP FEATURES



Sets up in minutes.



Adjust tent height with the push of a button.



Crank-up canopy creates a taut, clean peak.



Secure tent to the ground with stake kit.



Collapses easily to store in soft case with wheels.



Patent #D760857
Easy-Glide Tent Feet for mobility.



10' tent with dye sublimation, shown with dye sublimated double-sided full wall (wall sold separately; see page 115)

Choose Your Imprint Locations



One imprint per location (peak or valance).
Maximum of eight locations per tent.
Only one setup fee per tent.

Kit Includes:



Soft Carry Case with Wheels



Stake Kit

STANDARD 10' TENT

This popular tent strikes a perfect balance between cost effectiveness and portability.

- 1 mm pebble powder-coated steel frame
- 1.125" square legs
- ABS nylon joints
- Crank-up canopy creates a taut, clean peak
- 10' canopy available in eight stock colors (see page 103) or with full-bleed dye sublimation



Quick Ship Standard 10' Tent

Item #	Description	1	2-5
240680	24-Hour Full-Color Imprint Kit (1 Location)	810.00	700.00
240681	24-Hour Full-Color Imprint Kit (2 Locations)	884.00	772.00
240682	24-Hour Full-Color Imprint Kit (3 Locations)	958.00	844.00
240683	24-Hour Full-Color Imprint Kit (4 Locations)	1032.00	916.00
240688	48-Hour Dye Sublimation Kit	1663.20	NA

USD MSRP (C)

Order must be placed via our website.
See page 226 for complete Quick Ship program requirements and ordering information.



Easy-Glide Tent Feet allow the tent frame to slide on dirt and grass, preventing the legs from catching.
US Patent #D760857



Legs feature plastic push buttons for pinch-free height adjustments.

Standard 10' Tent

Item #	Description	1	2-5	6-11	12-24
240610	Unimprinted Kit	495.00	475.00	460.00	440.00
240611	Full-Color Imprint Kit (1 Location)	569.00	547.00	530.00	508.00
240612	Full-Color Imprint Kit (2 Locations)	643.00	619.00	600.00	576.00
240613	Full-Color Imprint Kit (3 Locations)	717.00	691.00	670.00	644.00
240614	Full-Color Imprint Kit (4 Locations)	791.00	763.00	740.00	712.00
240615	Full-Color Imprint Kit (5 Locations)	865.00	835.00	810.00	780.00
240616	Full-Color Imprint Kit (6 Locations)	939.00	907.00	880.00	848.00
240617	Full-Color Imprint Kit (7 Locations)	1013.00	979.00	950.00	916.00
240618	Full-Color Imprint Kit (8 Locations)	1087.00	1051.00	1020.00	984.00
240619	Dye Sublimation Kit	1213.00	1177.00	1146.00	1110.00

USD MSRP (C)

Product Size: 118.5"W x 127.5"-140"H x 118.5"D Imprint Graphic Size: Peak: 44"W x 24"H; Valance: 60"W x 8"H Dye Sub Graphic Size: View Online Template Product Wt. 51.5 lbs.

UNIMPRINTED CANOPY LEAD TIME: SHIPS SAME DAY WHEN ORDERED BEFORE 2 PM CENTRAL

Canopy: Weather-resistant, UV protected 50+, 400 denier polyester.

Shipping Case: Double-wall shipping box with cardboard inserts.

Setup fee: \$20.00(G); no setup fee on orders placed via our website; see page 224 for details.

View current graphic templates, assembly videos and instructions on our website.

See pages 224-226 for additional information that may apply to your order.

IMPRINT DYE SUB
3 OR 7 DAYS
AFTER FINAL PROOF APPROVAL
PRODUCTION LEAD TIME IS

Choose Your Imprint Locations



One imprint per location (peak or valance).
Maximum of eight locations per tent.
Only one setup fee per tent.

Kit Includes:



Soft Carry Case with Wheels



Stake Kit



10' tent with full-color imprint (8 locations)

DELUXE 10' TENT

Designed for frequent use, this tent features a stronger, heavier steel frame than that of the Standard.

- 1 mm pebble powder-coated steel frame
- 1.25" square legs
- ABS glass-filled nylon joints
- Crank-up canopy creates a taut, clean peak
- Canopy available in eight stock colors (see page 103) or with full-bleed dye sublimation



Deluxe 10' Tent

Item #	Description	1	2-5	6-11	12-24
240620	Unimprinted Kit	615.00	595.00	580.00	560.00
240621	Full-Color Imprint Kit (1 Location)	689.00	667.00	650.00	628.00
240622	Full-Color Imprint Kit (2 Locations)	763.00	739.00	720.00	696.00
240623	Full-Color Imprint Kit (3 Locations)	837.00	811.00	790.00	764.00
240624	Full-Color Imprint Kit (4 Locations)	911.00	883.00	860.00	832.00
240625	Full-Color Imprint Kit (5 Locations)	985.00	955.00	930.00	900.00
240626	Full-Color Imprint Kit (6 Locations)	1059.00	1027.00	1000.00	968.00
240627	Full-Color Imprint Kit (7 Locations)	1133.00	1099.00	1070.00	1036.00
240628	Full-Color Imprint Kit (8 Locations)	1207.00	1171.00	1140.00	1104.00
240629	Dye Sublimation Kit	1333.00	1297.00	1266.00	1230.00

USD MSRP (C)

Product Size 118.5"W x 127"-139.5"H x 118.5"D
Imprint Graphic Size Peak: 44"W x 24"H; Valance: 60"W x 8"H
Dye Sub Graphic Size View Online Template
Product Wt. 63.5 lbs.



Quick Ship Deluxe 10' Tent

Item #	Description	1	2-5
240690	24-Hour Full-Color Imprint Kit (1 Location)	930.00	820.00
240691	24-Hour Full-Color Imprint Kit (2 Locations)	1004.00	892.00
240692	24-Hour Full-Color Imprint Kit (3 Locations)	1078.00	964.00
240693	24-Hour Full-Color Imprint Kit (4 Locations)	1152.00	1036.00
240698	48-Hour Dye Sublimation Kit	1783.00	NA

USD MSRP (C)

Order must be placed via our website.
See page 226 for complete Quick Ship program requirements and ordering information.



Easy-Glide Tent Feet allow the tent frame to slide on dirt and grass, preventing the legs from catching. US Patent #D760857



Legs feature levers for easy height adjustments.

UNIMPRINTED CANOPY LEAD TIME: SHIPS SAME DAY WHEN ORDERED BEFORE 2 PM CENTRAL

Canopy: Weather-resistant, UV protected 50+, 400 denier polyester.
Shipping Case: Double-wall shipping box with cardboard inserts.
Setup fee: \$20.00(G); no setup fee on orders placed via our website; see page 224 for details.
View current graphic templates, assembly videos and instructions on our website.
See pages 224-226 for additional information that may apply to your order.

IMPRINT | DYE SUB
37 DAYS
AFTER FINAL PROOF APPROVAL
PRODUCTION LEAD TIME IS



10' tent with dye sublimation, shown with dye sublimated double-sided full wall (full wall sold separately; see pages 115)

Choose Your Imprint Locations



One imprint per location (peak or valance).
Maximum of eight locations per tent.
Only one setup fee per tent.

Kit Includes:



Soft Carry Case with Wheels



Stake Kit

PREMIUM 10' TENT

This Premium tent features a strong aluminum frame with sturdy hexagon-shaped legs.

- 0.8 mm anodized aluminum frame
- ABS glass-filled nylon joints
- 1.75" diameter hexagon-shaped legs for strength
- Crank-up canopy creates a taut, clean peak
- Canopy available in eight stock colors (see page 103) or with full-bleed dye sublimation



Quick Ship Premium 10' Tent

Item #	Description	1	2-5
240700	24-Hour Full-Color Imprint Kit (1 Location)	1050.00	940.00
240701	24-Hour Full-Color Imprint Kit (2 Locations)	1124.00	1012.00
240702	24-Hour Full-Color Imprint Kit (3 Locations)	1198.00	1084.00
240703	24-Hour Full-Color Imprint Kit (4 Locations)	1272.00	1156.00
240708	48-Hour Dye Sublimation Kit	1903.00	NA

USD MSRP (C)

Order must be placed via our website.
See page 226 for complete Quick Ship program requirements and ordering information.



Easy-Glide Tent Feet allow the tent frame to slide on dirt and grass, preventing the legs from catching. US Patent #D760857



Legs feature levers for easy height adjustments.

Premium 10' Tent

Item #	Description	1	2-5	6-11	12-24
240630	Unimprinted Kit	735.00	715.00	700.00	680.00
240631	Full-Color Imprint Kit (1 Location)	809.00	787.00	770.00	748.00
240632	Full-Color Imprint Kit (2 Locations)	883.00	859.00	840.00	816.00
240633	Full-Color Imprint Kit (3 Locations)	957.00	931.00	910.00	884.00
240634	Full-Color Imprint Kit (4 Locations)	1031.00	1003.00	980.00	952.00
240635	Full-Color Imprint Kit (5 Locations)	1105.00	1075.00	1050.00	1020.00
240636	Full-Color Imprint Kit (6 Locations)	1179.00	1147.00	1120.00	1088.00
240637	Full-Color Imprint Kit (7 Locations)	1253.00	1219.00	1190.00	1156.00
240638	Full-Color Imprint Kit (8 Locations)	1327.00	1291.00	1260.00	1224.00
240639	Dye Sublimation Kit	1453.00	1417.00	1386.00	1350.00

USD MSRP (C)

Product Size: 118"W x 126.75"H x 139.25"D x 118"D
Imprint Graphic Size: Peak: 44"W x 24"H; Valance: 60"W x 8"H
Dye Sub Graphic Size: View Online Template
Product Wt.: 52 lbs.

UNIMPRINTED CANOPY LEAD TIME: SHIPS SAME DAY WHEN ORDERED BEFORE 2 PM CENTRAL

Canopy: Weather-resistant, UV protected 50+, 400 denier polyester.

Shipping Case: Double-wall shipping box with cardboard inserts.

Setup fee: \$20.00(G); no setup fee on orders placed via our website; see page 224 for details.

View current graphic templates, assembly videos and instructions on our website.

See pages 224-226 for additional information that may apply to your order.

IMPRINT DYE SUB
3 OF 7 DAYS
AFTER FINAL PROOF APPROVAL
PRODUCTION LEAD TIME IS

Choose Your Imprint Locations



One imprint per location (peak or valance).
Maximum of eight locations per tent.
Only one setup fee per tent.

Kit Includes:



Soft Carry Case with Wheels



Stake Kit



ELITE 10' TENT

Designed to last a lifetime, the Elite tent features our strongest, most robust frame and adds a professional touch to any event.

- 50 mm aluminum hexagon-shaped legs
- Machined aluminum joints
- Self-adjusting spring tension frame creates a taut, clean canopy peak
- Lifetime warranty on frame
- Canopy available in eight stock colors (see page 103) or with full-bleed dye sublimation



Elite 10' Tent

Item #	Description	1	2-5	6-11	12-24
240980	Unimprinted Kit	1215.00	1190.00	1165.00	1130.00
240981	Full-Color Imprint Kit (1 Location)	1289.00	1262.00	1235.00	1198.00
240982	Full-Color Imprint Kit (2 Locations)	1363.00	1334.00	1305.00	1266.00
240983	Full-Color Imprint Kit (3 Locations)	1437.00	1406.00	1375.00	1334.00
240984	Full-Color Imprint Kit (4 Locations)	1511.00	1478.00	1445.00	1402.00
240985	Full-Color Imprint Kit (5 Locations)	1585.00	1550.00	1515.00	1470.00
240986	Full-Color Imprint Kit (6 Locations)	1659.00	1622.00	1585.00	1538.00
240987	Full-Color Imprint Kit (7 Locations)	1733.00	1694.00	1655.00	1606.00
240988	Full-Color Imprint Kit (8 Locations)	1807.00	1766.00	1725.00	1674.00
240989	Dye Sublimation Kit	1933.00	1892.00	1851.00	1800.00

USD MSRP (C)

Product Size: 118"W x 116.75"H-128.25"H x 118"D
Imprint Graphic Size: Peak: 44"W x 24"H; Valance: 60"W x 8"H
Dye Sub Graphic Size: View Online Template
Product Wt.: 78.5 lbs.



Heavy-Duty Frame!

The strongest tent on the market.



Easy-Glide Tent Feet allow the tent frame to slide on dirt and grass, preventing the legs from catching. US Patent #D760857



Legs feature levers for easy height adjustments.

UNIMPRINTED CANOPY LEAD TIME: SHIPS SAME DAY WHEN ORDERED BEFORE 2 PM CENTRAL

Canopy: Weather-resistant, UV protected 50+, 400 denier polyester.
Shipping Case: Double-wall shipping box with cardboard inserts.
Setup fee: \$20.00(G); no setup fee on orders placed via our website; see page 224 for details.
View current graphic templates, assembly videos and instructions on our website.
See pages 224-226 for additional information that may apply to your order.

IMPRINT | DYE SUB
37 DAYS
AFTER FINAL PROOF APPROVAL
PRODUCTION LEAD TIME IS



10' tent with dye sublimation

Choose Your Imprint Locations



One imprint per location (peak or valance).
Maximum of eight locations per tent.
Only one setup fee per tent.

Kit Includes:



Soft Carry Case with Wheels



Stake Kit

33% Shorter



Collapsed height is 33% shorter than our other tent frames.



Soft-grade polypropylene leg slider guides protect the frame's finish and allow legs to telescope smoothly.



Legs feature levers for easy height adjustments.



Easy-Glide Tent Feet allow the tent frame to slide on dirt and grass, preventing the legs from catching. US Patent #D760857

COMPACT 10' TENT

This tent frame folds into a compact unit designed to fit into the trunk of a mid-sized vehicle for easy transport.

- When set up, the Compact tent is approximately the same size as our other 10' tents
- Legs feature three telescoping segments instead of two - 1 mm anodized aluminum frame
- 1.25" square legs
- Crank-up canopy creates a taut, clean peak
- Canopy available in eight stock colors (see page 103) or with full-bleed dye sublimation



Compact 10' Tent

Item #	Description	1	2-5	6-11	12-24
240960	Unimprinted Kit	825.00	805.00	780.00	760.00
240961	Full-Color Imprint Kit (1 Location)	899.00	877.00	850.00	828.00
240962	Full-Color Imprint Kit (2 Locations)	973.00	949.00	920.00	896.00
240963	Full-Color Imprint Kit (3 Locations)	1047.00	1021.00	990.00	964.00
240964	Full-Color Imprint Kit (4 Locations)	1121.00	1093.00	1060.00	1032.00
240965	Full-Color Imprint Kit (5 Locations)	1195.00	1165.00	1130.00	1100.00
240966	Full-Color Imprint Kit (6 Locations)	1269.00	1237.00	1200.00	1168.00
240967	Full-Color Imprint Kit (7 Locations)	1343.00	1309.00	1270.00	1236.00
240968	Full-Color Imprint Kit (8 Locations)	1417.00	1381.00	1340.00	1304.00
240969	Dye Sublimation Kit	1543.00	1507.00	1466.00	1430.00

USD MSRP (C)

Product Size: 118.25"W x 121"-133.5"H x 118.25"D
 Imprint Graphic Size: Peak: 44"W x 24"H; Valance: 60"W x 8"H
 Dye Sub Graphic Size: View Online Template
 Product Wt.: 53 lbs.

UNIMPRINTED CANOPY LEAD TIME: SHIPS SAME DAY WHEN ORDERED BEFORE 2 PM CENTRAL

Canopy: Weather-resistant, UV protected 50+, 400 denier polyester.

Shipping Case: Double-wall shipping box.

Setup fee: \$20.00(G); no setup fee on orders placed via our website; see page 224 for details.

View current graphic templates, assembly videos and instructions on our website.

See pages 224-226 for additional information that may apply to your order.

3 or 7 DAYS
IMPRINT DYE SUB
AFTER FINAL PROOF APPROVAL PRODUCTION LEAD TIME IS

Choose Your Imprint Locations



One imprint per location (peak or valance).
Maximum of eight locations per tent.
Only one setup fee per tent.

Kit Includes:



Soft Carry Case with Wheels



Stake Kit



Premium 10' tent with vented canopy, full-color imprint (8 locations)



Deluxe 10' tent with vented canopy, full-color imprint (8 locations)

10' TENT WITH VENTED CANOPY

These tents feature a vented canopy to keep them stable when the wind picks up.

- Crank-up canopy creates a taut, clean peak
- Canopy available in white only
- Choose Deluxe or Premium tent hardware (see pages 105 and 106 for hardware details)



Deluxe 10' Tent with Vented Canopy

Item #	Description	1	2-5	6-11	12-24
240350	Unimprinted Kit	680.00	660.00	645.00	625.00
240351	Full-Color Imprint Kit (1 Location)	754.00	732.00	715.00	693.00
240352	Full-Color Imprint Kit (2 Locations)	828.00	804.00	785.00	761.00
240353	Full-Color Imprint Kit (3 Locations)	902.00	876.00	855.00	829.00
240354	Full-Color Imprint Kit (4 Locations)	976.00	948.00	925.00	897.00
240355	Full-Color Imprint Kit (5 Locations)	1050.00	1020.00	995.00	965.00
240356	Full-Color Imprint Kit (6 Locations)	1124.00	1092.00	1065.00	1033.00
240357	Full-Color Imprint Kit (7 Locations)	1198.00	1164.00	1135.00	1101.00
240358	Full-Color Imprint Kit (8 Locations)	1272.00	1236.00	1205.00	1169.00

USD MSRP (C)

Product Size: 118.5"W x 127"-139.5"H x 118.5"D
Imprint Graphic Size: Peak: 44"W x 24"H; Valance: 60"W x 8"H
Product Wt.: 62 lbs.

Premium 10' Tent with Vented Canopy

Item #	Description	1	2-5	6-11	12-24
240410	Unimprinted Kit	800.00	780.00	765.00	745.00
240411	Full-Color Imprint Kit (1 Location)	874.00	852.00	835.00	813.00
240412	Full-Color Imprint Kit (2 Locations)	948.00	924.00	905.00	881.00
240413	Full-Color Imprint Kit (3 Locations)	1022.00	996.00	975.00	949.00
240414	Full-Color Imprint Kit (4 Locations)	1096.00	1068.00	1045.00	1017.00
240415	Full-Color Imprint Kit (5 Locations)	1170.00	1140.00	1115.00	1085.00
240416	Full-Color Imprint Kit (6 Locations)	1244.00	1212.00	1185.00	1153.00
240417	Full-Color Imprint Kit (7 Locations)	1318.00	1284.00	1255.00	1221.00
240418	Full-Color Imprint Kit (8 Locations)	1392.00	1356.00	1325.00	1289.00

USD MSRP (C)

Product Size: 120"W x 126.75"-139.25"H x 120"D
Imprint Graphic Size: Peak: 44"W x 24"H; Valance: 60"W x 8"H
Product Wt.: 50.5 lbs.



Vented canopy peak allows air to flow through to prevent wind damage.



Easy-Glide Tent Feet allow the tent frame to slide on dirt and grass, preventing the legs from catching. US Patent #D760857

UNIMPRINTED CANOPY LEAD TIME: SHIPS SAME DAY WHEN ORDERED BEFORE 2 PM CENTRAL

Canopy: Weather-resistant, UV protected 50+, 400 denier polyester.
Shipping Case: Double-wall shipping box with cardboard inserts.
Setup fee: \$20.00(G); no setup fee on orders placed via our website; see page 224 for details.
View current graphic templates, assembly videos and instructions on our website.
See pages 224-226 for additional information that may apply to your order.

IMPRINT | DYE SUB
37 DAYS
AFTER FINAL PROOF APPROVAL
PRODUCTION LEAD TIME IS



8' tent with dye sublimation

6' tent with full-color imprint (8 locations)

Choose Your Imprint Locations



One imprint per location (peak or valance).
Maximum of eight locations per tent.
Only one setup fee per tent.

Kit Includes:



Soft Carry Case with Wheels



Stake Kit

DELUXE 6' & 8' TENTS

6' and 8' tents are compact enough for use indoors or in tight spaces.

- 1 mm pebble powder-coated steel frame
- 1.25" square legs
- ABS glass-filled nylon joints
- Crank-up canopy creates a taut, clean peak



Deluxe 6' Tent

Item #	Description	1	2-5	6-11	12-24
240800	Unimprinted Kit	540.00	530.00	520.00	500.00
240801	Full-Color Imprint Kit (1 Location)	614.00	602.00	590.00	568.00
240802	Full-Color Imprint Kit (2 Locations)	688.00	674.00	660.00	636.00
240803	Full-Color Imprint Kit (3 Locations)	762.00	746.00	730.00	704.00
240804	Full-Color Imprint Kit (4 Locations)	836.00	818.00	800.00	772.00
240805	Full-Color Imprint Kit (5 Locations)	910.00	890.00	870.00	840.00
240806	Full-Color Imprint Kit (6 Locations)	984.00	962.00	940.00	908.00
240807	Full-Color Imprint Kit (7 Locations)	1058.00	1034.00	1010.00	976.00
240808	Full-Color Imprint Kit (8 Locations)	1132.00	1106.00	1080.00	1044.00
240809	Dye Sublimation Kit	1258.00	1232.00	1206.00	1170.00

USD MSRP (C)

Product Size: 72"W x 109"-121.5"H x 72"D
Imprint Graphic Size: Peak: 24"W x 20"H; Valance: 50"W x 8"H
Dye Sub Graphic Size: View Online Template
Product Wt.: 48.5 lbs.

Deluxe 8' Tent

Item #	Description	1	2-5	6-11	12-24
240820	Unimprinted Kit	560.00	550.00	540.00	520.00
240821	Full-Color Imprint Kit (1 Location)	634.00	622.00	610.00	588.00
240822	Full-Color Imprint Kit (2 Locations)	708.00	694.00	680.00	656.00
240823	Full-Color Imprint Kit (3 Locations)	782.00	766.00	750.00	724.00
240824	Full-Color Imprint Kit (4 Locations)	856.00	838.00	820.00	792.00
240825	Full-Color Imprint Kit (5 Locations)	930.00	910.00	890.00	860.00
240826	Full-Color Imprint Kit (6 Locations)	1004.00	982.00	960.00	928.00
240827	Full-Color Imprint Kit (7 Locations)	1078.00	1054.00	1030.00	996.00
240828	Full-Color Imprint Kit (8 Locations)	1152.00	1126.00	1100.00	1064.00
240829	Dye Sublimation Kit	1278.00	1252.00	1226.00	1190.00

USD MSRP (C)

Product Size: 96"W x 117.5"-130"H x 96"D
Imprint Graphic Size: Peak: 36"W x 28"H; Valance: 50"W x 8"H
Dye Sub Graphic Size: View Online Template
Product Wt.: 58 lbs.



Easy-Glide Tent Feet allow the tent frame to slide on dirt and grass, preventing the legs from catching. US Patent #D760857



Legs feature levers for easy height adjustments.

6' & 8' Stock Canopy Colors

- Black
- Red PMS 1795
- Royal Blue PMS 2728
- White

PMS colors are for reference only and may vary slightly from actual color.

UNIMPRINTED CANOPY LEAD TIME: SHIPS SAME DAY WHEN ORDERED BEFORE 2 PM CENTRAL

Canopy: Weather-resistant, UV protected 50+, 400 denier polyester.

Shipping Case: Double-wall shipping box with cardboard inserts.

Setup fee: \$20.00(G); no setup fee on orders placed via our website; see page 224 for details.

View current graphic templates, assembly videos and instructions on our website.

See pages 224-226 for additional information that may apply to your order.

3 or 7 DAYS
AFTER FINAL PROOF APPROVAL
PRODUCTION LEAD TIME IS

Choose Your Imprint Locations



One imprint per location (peak or valance).
Maximum of twelve locations per tent.
Only one setup fee per tent.

Kit Includes:



Soft Carry Case with Wheels



Stake Kit



20' tent with dye sublimation

15' tent with full-color imprint (12 locations)

PREMIUM 15' & 20' TENTS

Our two largest tent sizes give you ample space for displaying your products, serving refreshments or just keeping out of the sun.

- 0.8 mm anodized aluminum frame
- ABS glass-filled nylon joints
- 1.75" diameter hexagon legs for strength
- Crank-up canopy creates a taut, clean peak
- Canopy available in white or with full-bleed dye sublimation



Easy-Glide Tent Feet allow the tent frame to slide on dirt and grass, preventing the legs from catching. US Patent #D760857



Legs feature levers for easy height adjustments.

Premium 10' x 15' Tent

Item #	Description	1	2-5	6-11	12-24
240550	Unimprinted Kit	850.00	835.00	815.00	790.00
240551	Full-Color Imprint Kit (1 Location)	924.00	907.00	885.00	858.00
240552	Full-Color Imprint Kit (2 Locations)	998.00	979.00	955.00	926.00
240553	Full-Color Imprint Kit (3 Locations)	1072.00	1051.00	1025.00	994.00
240554	Full-Color Imprint Kit (4 Locations)	1146.00	1123.00	1095.00	1062.00
240555	Full-Color Imprint Kit (5 Locations)	1220.00	1195.00	1165.00	1130.00
240556	Full-Color Imprint Kit (6 Locations)	1294.00	1267.00	1235.00	1198.00
240557	Full-Color Imprint Kit (7 Locations)	1368.00	1339.00	1305.00	1266.00
240558	Full-Color Imprint Kit (8 Locations)	1442.00	1411.00	1375.00	1334.00
240559	Full-Color Imprint Kit (9 Locations)	1516.00	1483.00	1445.00	1402.00
240560	Full-Color Imprint Kit (10 Locations)	1590.00	1555.00	1515.00	1470.00
240561	Full-Color Imprint Kit (11 Locations)	1664.00	1627.00	1585.00	1538.00
240562	Full-Color Imprint Kit (12 Locations)	1738.00	1699.00	1655.00	1606.00
240563	Dye Sublimation Kit	1875.00	1836.00	1792.00	1743.00

USD MSRP (C)

Product Size: 175.5"W x 126.75"H x 139.25"H x 118.25"D
Imprint Graphic Size: Peak: 44"W x 24"H, Valance: 60"W x 8"H
Dye Sub Graphic Size: View Online Template
Product Wt.: 70.5 lbs.

Premium 10' x 20' Tent

Item #	Description	1	2-5	6-11	12-24
240570	Unimprinted Kit	965.00	945.00	925.00	895.00
240571	Full-Color Imprint Kit (1 Location)	1039.00	1017.00	995.00	963.00
240572	Full-Color Imprint Kit (2 Locations)	1113.00	1089.00	1065.00	1031.00
240573	Full-Color Imprint Kit (3 Locations)	1187.00	1161.00	1135.00	1099.00
240574	Full-Color Imprint Kit (4 Locations)	1261.00	1233.00	1205.00	1167.00
240575	Full-Color Imprint Kit (5 Locations)	1335.00	1305.00	1275.00	1235.00
240576	Full-Color Imprint Kit (6 Locations)	1409.00	1377.00	1345.00	1303.00
240577	Full-Color Imprint Kit (7 Locations)	1483.00	1449.00	1415.00	1371.00
240578	Full-Color Imprint Kit (8 Locations)	1557.00	1521.00	1485.00	1439.00
240579	Full-Color Imprint Kit (9 Locations)	1631.00	1593.00	1555.00	1507.00
240580	Full-Color Imprint Kit (10 Locations)	1705.00	1665.00	1625.00	1575.00
240581	Full-Color Imprint Kit (11 Locations)	1779.00	1737.00	1695.00	1643.00
240582	Full-Color Imprint Kit (12 Locations)	1853.00	1809.00	1765.00	1711.00
240583	Dye Sublimation Kit	1990.00	1946.00	1902.00	1848.00

USD MSRP (C)

Product Size: 234.5"W x 126.75"H x 139.25"H x 118.25"D
Imprint Graphic Size: Peak: 44"W x 24"H, Valance: 60"W x 8"H
Dye Sub Graphic Size: View Online Template
Product Wt.: 92 lbs.

UNIMPRINTED CANOPY LEAD TIME: SHIPS SAME DAY WHEN ORDERED BEFORE 2 PM CENTRAL

Canopy: Weather-resistant, UV protected 50+, 400 denier polyester.
Shipping Case: Double-wall shipping box with cardboard inserts.
Setup fee: \$20.00(G); no setup fee on orders placed via our website; see page 224 for details.
View current graphic templates, assembly videos and instructions on our website.
See pages 224-226 for additional information that may apply to your order.

IMPRINT | DYE SUB
37 DAYS
AFTER FINAL PROOF APPROVAL
PRODUCTION LEAD TIME IS

PREMIUM GABLE TENTS

This tent stands out from the crowd with a unique gable shape, allowing for more visible space to share your message.

- Available in 10', 15' and 20' sizes
- 0.8 mm anodized aluminum frame
- ABS glass-filled nylon joints
- 1.75" diameter hexagon legs for strength
- 10' x 10' tents have three center poles, 10' x 15' have four center poles and 10' x 20' have five center poles
- 10' canopy available in eight stock colors (see page 103) or with full-bleed dye sublimation
- 15' and 20' canopies available in white or with full-bleed dye sublimation



Center poles crank up to create a taut gable shape.



Legs feature levers for easy height adjustments.



Easy-Glide Tent Feet allow the tent frame to slide on dirt and grass, preventing the legs from catching. US Patent #D760857

10' Tent with dye sublimation

Choose Your Imprint Locations



One imprint per location (peak or valance).
 Maximum of eight locations per 10' tent;
 Maximum of 12 locations per 15' & 20' tents.
 Only one setup fee per tent.

Kit Includes:



Soft Carry Case with Wheels



Stake Kit

Premium Gable 10' x 10' Tent

Item #	Description	1	2-5	6-11	12-24
241120	Unimprinted Kit	830.00	815.00	795.00	770.00
241121	Full-Color Imprint Kit (1 Location)	904.00	887.00	865.00	838.00
241122	Full-Color Imprint Kit (2 Locations)	978.00	959.00	935.00	906.00
241123	Full-Color Imprint Kit (3 Locations)	1052.00	1031.00	1005.00	974.00
241124	Full-Color Imprint Kit (4 Locations)	1126.00	1103.00	1075.00	1042.00
241125	Full-Color Imprint Kit (5 Locations)	1200.00	1175.00	1145.00	1110.00
241126	Full-Color Imprint Kit (6 Locations)	1274.00	1247.00	1215.00	1178.00
241127	Full-Color Imprint Kit (7 Locations)	1348.00	1319.00	1285.00	1246.00
241128	Full-Color Imprint Kit (8 Locations)	1422.00	1391.00	1355.00	1314.00
241129	Dye Sublimation Kit	1548.00	1517.00	1481.00	1440.00

USD MSRP (C)

Product Size 118"W x 119.25"H x 118"D
Imprint Graphic Size Flat Peak: 44"W x 11.25"H; Sloping Peak 44"W x 24"H
Dye Sub Graphic Size View Online Template
Product Wt. 55 lbs.



10' tent with full-color imprint (8 locations)

Premium Gable 10' x 15' Tent

Item #	Description	1	2-5	6-11	12-24
241130	Unimprinted Kit	940.00	920.00	900.00	875.00
241131	Full-Color Imprint Kit (1 Location)	1014.00	992.00	970.00	943.00
241132	Full-Color Imprint Kit (2 Locations)	1088.00	1064.00	1040.00	1011.00
241133	Full-Color Imprint Kit (3 Locations)	1162.00	1136.00	1110.00	1079.00
241134	Full-Color Imprint Kit (4 Locations)	1236.00	1208.00	1180.00	1147.00
241135	Full-Color Imprint Kit (5 Locations)	1310.00	1280.00	1250.00	1215.00
241136	Full-Color Imprint Kit (6 Locations)	1384.00	1352.00	1320.00	1283.00
241137	Full-Color Imprint Kit (7 Locations)	1458.00	1424.00	1390.00	1351.00
241138	Full-Color Imprint Kit (8 Locations)	1532.00	1496.00	1460.00	1419.00
241139	Full-Color Imprint Kit (9 Locations)	1606.00	1568.00	1530.00	1487.00
241140	Full-Color Imprint Kit (10 Locations)	1680.00	1640.00	1600.00	1555.00
241141	Full-Color Imprint Kit (11 Locations)	1754.00	1712.00	1670.00	1623.00
241142	Full-Color Imprint Kit (12 Locations)	1828.00	1784.00	1740.00	1691.00
241143	Dye Sublimation Kit	1965.00	1921.00	1877.00	1828.00

USD MSRP (C)

Product Size 175.5"W x 119.25"H x 118.25"D
Imprint Graphic Size Flat Peak: 44"W x 11.25"H; Sloping Peak 44"W x 24"H
Dye Sub Graphic Size View Online Template
Product Wt. 70.5 lbs.



15' tent with dye sublimation

Premium Gable 10' x 20' Tent

Item #	Description	1	2-5	6-11	12-24
241170	Unimprinted Kit	1285.00	1260.00	1235.00	1195.00
241171	Full-Color Imprint Kit (1 Location)	1359.00	1332.00	1305.00	1263.00
241172	Full-Color Imprint Kit (2 Locations)	1433.00	1404.00	1375.00	1331.00
241173	Full-Color Imprint Kit (3 Locations)	1507.00	1476.00	1445.00	1399.00
241174	Full-Color Imprint Kit (4 Locations)	1581.00	1548.00	1515.00	1467.00
241175	Full-Color Imprint Kit (5 Locations)	1655.00	1620.00	1585.00	1535.00
241176	Full-Color Imprint Kit (6 Locations)	1729.00	1692.00	1655.00	1603.00
241177	Full-Color Imprint Kit (7 Locations)	1803.00	1764.00	1725.00	1671.00
241178	Full-Color Imprint Kit (8 Locations)	1877.00	1836.00	1795.00	1739.00
241179	Full-Color Imprint Kit (9 Locations)	1951.00	1908.00	1865.00	1807.00
241180	Full-Color Imprint Kit (10 Locations)	2025.00	1980.00	1935.00	1875.00
241181	Full-Color Imprint Kit (11 Locations)	2099.00	2052.00	2005.00	1943.00
241182	Full-Color Imprint Kit (12 Locations)	2173.00	2124.00	2075.00	2011.00
241183	Dye Sublimation Kit	2310.00	2261.00	2212.00	2148.00

USD MSRP (C)

Product Size 234.5"W x 119.25"H x 118.25"D
Imprint Graphic Size Flat Peak: 44"W x 11.25"H; Sloping Peak 44"W x 24"H
Dye Sub Graphic Size View Online Template
Product Wt. 91.5 lbs.



20' tent with full-color imprint (12 locations)

UNIMPRINTED CANOPY LEAD TIME: SHIPS SAME DAY WHEN ORDERED BEFORE 2 PM CENTRAL

Canopy: Weather-resistant, UV protected 50+, 400 denier polyester.
 Shipping Case: Double-wall shipping box with cardboard inserts.
 Setup fee: \$20.00(G); no setup fee on orders placed via our website; see page 224 for details.
 View current graphic templates, assembly videos and instructions on our website.
 See pages 224-226 for additional information that may apply to your order.

IMPRINT | DYE SUB
37 DAYS
 AFTER FINAL PROOF APPROVAL
 PRODUCTION LEAD TIME IS



Half Wall Stock Colors

- Black ○ White

15' walls available in white only

10' half wall kit with full-color imprint



10' mesh half wall kit with full-color UV

TENT WALLS

With several creative options to choose from, you can customize your tent for a truly unique look.

- 6' and 8' walls available in 400 denier polyester
- 10' and 15' walls available in 400 denier polyester or Titan™ 9 oz. mesh vinyl
- Walls can be applied facing inward or outward
- Tent frame and canopy sold separately



Standard Tent Frame Half Wall Kits

Item #	Description	1	2-5	6-11	12-24
240336	10' Half Wall Kit (Unimprinted)	173.00	167.00	161.00	155.00
240339	10' Half Wall Kit (Full-Color Imprint)	270.00	265.00	260.00	250.00
240342	10' Half Wall Kit (Dye Sublimation)	375.00	370.00	365.00	350.00
240375	10' Double-Sided Half Wall Kit (Dye Sublimation)	455.00	443.00	431.00	419.00
240422	10' Mesh Half Wall Kit (Unimprinted)	173.00	167.00	161.00	155.00
240425	10' Mesh Half Wall Kit (Full-Color UV)	270.00	265.00	260.00	250.00

Kit Includes: Half Wall, Stabilizing Bar and 2 Clamps
USD MSRP (C)

Deluxe Tent Frame Half Wall Kits

Item #	Description	1	2-5	6-11	12-24
240854	6' Half Wall Kit (Unimprinted)	143.00	139.00	134.00	130.00
240855	6' Half Wall Kit (Full-Color Imprint)	233.00	226.00	219.00	212.00
240856	6' Half Wall Kit (Dye Sublimation)	330.00	320.00	310.00	300.00
240857	6' Double-Sided Half Wall Kit (Dye Sublimation)	420.00	410.00	405.00	390.00
240884	8' Half Wall Kit (Unimprinted)	153.00	148.00	144.00	139.00
240885	8' Half Wall Kit (Full-Color Imprint)	245.00	238.00	230.00	223.00
240886	8' Half Wall Kit (Dye Sublimation)	340.00	335.00	325.00	315.00
240887	8' Double-Sided Half Wall Kit (Dye Sublimation)	430.00	420.00	415.00	400.00
240337	10' Half Wall Kit (Unimprinted)	173.00	167.00	161.00	155.00
240340	10' Half Wall Kit (Full-Color Imprint)	270.00	265.00	260.00	250.00
240343	10' Half Wall Kit (Dye Sublimation)	375.00	370.00	365.00	350.00
240376	10' Double-Sided Half Wall Kit (Dye Sublimation)	455.00	443.00	431.00	419.00
240423	10' Mesh Half Wall Kit (Unimprinted)	173.00	167.00	161.00	155.00
240426	10' Mesh Half Wall Kit (Full-Color UV)	270.00	265.00	260.00	250.00

Kit Includes: Half Wall, Stabilizing Bar and 2 Clamps
USD MSRP (C)

Premium Tent Frame Half Wall Kits

Item #	Description	1	2-5	6-11	12-24
240338	10' Half Wall Kit (Unimprinted)	173.00	167.00	161.00	155.00
240341	10' Half Wall Kit (Full-Color Imprint)	268.00	262.00	256.00	250.00
240344	10' Half Wall Kit (Dye Sublimation)	375.00	370.00	365.00	350.00
240377	10' Double-Sided Half Wall Kit (Dye Sublimation)	455.00	443.00	431.00	419.00
240424	10' Mesh Half Wall Kit (Unimprinted)	173.00	167.00	161.00	155.00
240427	10' Mesh Half Wall Kit (Full-Color UV)	270.00	265.00	260.00	250.00
240515	15' Half Wall Kit (Unimprinted)	232.00	225.00	218.00	211.00
240516	15' Half Wall Kit (Full-Color Imprint)	375.00	370.00	360.00	350.00
240517	15' Half Wall Kit (Dye Sublimation)	525.00	515.00	505.00	490.00
240518	15' Mesh Half Wall Kit (Unimprinted)	232.00	225.00	218.00	211.00
240519	15' Mesh Half Wall Kit (Full-Color UV)	375.00	370.00	360.00	350.00

Kit Includes: Half Wall, Stabilizing Bar and 2 Clamps
USD MSRP (C)

Compact Tent Frame Half Wall Kits

Item #	Description	1	2-5	6-11	12-24
240506	10' Half Wall Kit (Unimprinted)	173.00	167.00	161.00	155.00
240507	10' Half Wall Kit (Full-Color Imprint)	268.00	262.00	256.00	250.00
240508	10' Half Wall Kit (Dye Sublimation)	375.00	370.00	365.00	350.00
240509	10' Double-Sided Half Wall Kit (Dye Sublimation)	455.00	443.00	431.00	419.00

Kit Includes: Half Wall, Stabilizing Bar and 2 Clamps
USD MSRP (C)

Description	Product Size	Graphic Size	Dye Sub / UV Graphic Size	Product Wt. (Imprint / Dye Sub / Double-Sided / Mesh)
6'	72"W x 38"H x 2.25"D	50"W x 24"H	View Online Template	4.25 lbs. / 4.75 lbs. / 6.25 lbs. / NA
8'	96"W x 38"H x 2.25"D	50"W x 24"H	View Online Template	5 lbs. / 5.25 lbs. / 7.25 lbs. / NA
10'	Kit: 118"W x 38"H x 2.5"D	54"W x 24"H	View Online Template	4.75 lbs. / 5.25 lbs. / 7.25 lbs. / 5.5 lbs.
10' Compact	Kit: 118"W x 38"H x 2.5"D	54"W x 24"H	View Online Template	5.5 lbs. / 6 lbs. / 8 lbs. / NA
15'	Kit: 175.5"W x 38"H x 2.5"D	54"W x 24"H (2)	View Online Template	7.2 lbs. / 7.8 lbs. / NA / 8.35 lbs.

Add-On

90° connector clamp connects two stabilizing bars to keep half walls at the same level.



90° Connector Clamp

Item #	Description	1	2-5	6-11	12-24
240192	Standard Frame Connector Clamp	11.90	11.50	11.30	10.90
240193	Deluxe Frame Connector Clamp	11.90	11.50	11.30	10.90
240194	Premium Frame Connector Clamp	11.90	11.50	11.30	10.90

USD MSRP (C)

UV IMPRINT DYE SUB
2 OR 3 OR 7 DAYS
AFTER FINAL PROOF APPROVAL
PRODUCTION LEAD TIME IS

UNIMPRINTED WALL LEAD TIME: SHIPS SAME DAY WHEN ORDERED BEFORE 2 PM CENTRAL
Setup fee: \$20.00(G); no setup fee on orders placed via our website; see page 224 for details.
View current graphic templates, assembly videos and instructions on our website.
See pages 224-226 for additional information that may apply to your order.

Full Tent Walls

Item #	Description	1	2-5	6-11	12-24
240910	6' Full Wall (Unimprinted)	131.00	127.00	123.00	119.00
240911	6' Full Wall (Full-Color Imprint)	233.00	226.00	219.00	212.00
240912	6' Full Wall (Dye Sublimation)	490.00	480.00	470.00	455.00
240913	6' Double-Sided Full Wall (Dye Sublimation)	630.00	615.00	605.00	585.00
240918	8' Full Wall (Unimprinted)	143.00	139.00	134.00	130.00
240919	8' Full Wall (Full-Color Imprint)	245.00	240.00	235.00	225.00
240920	8' Full Wall (Dye Sublimation)	500.00	490.00	480.00	465.00
240921	8' Double-Sided Full Wall (Dye Sublimation)	645.00	630.00	620.00	600.00
240082	10' Full Wall (Unimprinted)	162.00	158.00	154.00	150.00
240083	10' Full Wall (Full-Color Imprint)	280.00	275.00	270.00	260.00
240084	10' Full Wall (Dye Sublimation)	540.00	535.00	530.00	520.00
240184	10' Double-Sided Full Wall (Dye Sublimation)	690.00	670.00	655.00	635.00
240432	10' Mesh Full Wall (Unimprinted)	162.00	158.00	154.00	150.00
240433	10' Mesh Full Wall (Full-Color UV)	280.00	275.00	270.00	260.00
240396	15' Full Wall (Unimprinted)	245.00	240.00	235.00	225.00
240397	15' Full Wall (Full-Color Imprint)	430.00	425.00	420.00	410.00
240398	15' Full Wall (Dye Sublimation)	805.00	795.00	780.00	770.00
240348	15' Double-Sided Full Wall (Dye Sublimation)	1050.00	1040.00	1030.00	1020.00
240436	15' Mesh Full Wall (Unimprinted)	245.00	240.00	235.00	225.00
240437	15' Mesh Full Wall (Full-Color UV)	430.00	425.00	420.00	410.00

USD MSRP (C)

Description	Product Size	Graphic Size	Dye Sub / UV Graphic Size	Product Wt. (Imprint / Dye Sub / Double-Sided / Mesh)
6'	71.75"W x 84.5"H	50"W x 30"H	View Online Template	2.5 lbs. / 3 lbs. / 6 lbs. / NA
8'	98.75"W x 84.5"H	50"W x 30"H	View Online Template	3 lbs. / 3.5 lbs. / 7 lbs. / NA
10'	118.25"W x 84.5"H	54"W x 30"H	View Online Template	3.4 lbs. / 4.4 lbs. / 10 lbs. / 4.5 lbs.
15'	176.75"W x 84.5"H	54"W x 30"H (2)	View Online Template	4.5 lbs. / 5.5 lbs. / 12.5 lbs. / 6.5 lbs.



Heavy-duty double-pull zippers on the sides of full walls let you connect multiple walls together.



Walls attach to a tent frame using hook-and-loop straps.



10' full wall with full-color imprint

Full Wall Stock Colors

● Black ○ White

15' walls available in white only

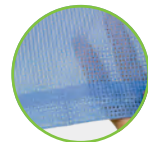

10' mesh full wall with full-color UV



10' quarter wall

Quarter Tent Walls

Item #	Description	1	2-5	6-11	12-24
240442	10' Single-Sided Quarter Wall (Dye Sublimation)	240.00	233.00	226.00	218.00
240443	10' Double-Sided Quarter Wall (Dye Sublimation)	285.00	276.00	268.00	259.00

USD MSRP (C)

Product Size	Dye Sub Graphic Size	Product Wt. (Single-Sided / Double-Sided)	Media
118.25"W x 18"H	View Online Template	1 lb. / 2 lbs.	400 Denier Polyester



INTERACTIVE TENT WALLS

An interactive element lets you offer experiences that won't be forgotten.

- Available in 400 denier polyester (single-sided only)
- Cutout hole locations are standard and cannot be customized
- Walls can be applied facing inward or outward
- Tent frame and canopy sold separately



Interactive Tent Walls

Item #	Description	1	2-5	6-11	12-24
240369	10' Face Cutout Wall (Dye Sublimation)	570.00	560.00	545.00	530.00
240370	10' Game Wall (Dye Sublimation)	685.00	670.00	660.00	635.00

USD MSRP (C)

Description	Product Size	Finished Graphic Size	Product Wt.	Media
10' Interactive Wall	118.25"W x 84.5"H	View Online Template	5 lbs.	400 Denier Polyester



Face cutouts are reinforced with black Lycra® binding.



Game Wall features 6", 8" and 10" diameter mesh pockets to catch bean bags (included).



Face Cutout wall

Game wall

UNIMPRINTED WALL LEAD TIME: SHIPS SAME DAY WHEN ORDERED BEFORE 2 PM CENTRAL

Setup fee: \$20.00(G); no setup fee on orders placed via our website; see page 224 for details.

View current graphic templates, assembly videos and instructions on our website.

See pages 224-226 for additional information that may apply to your order.

UV IMPRINT DYE SUB AFTER FINAL PROOF APPROVAL PRODUCTION LEAD TIME IS
237 DAYS



Shown on a 10' tent (sold separately)

10' TENT VALANCE WRAP

This banner wraps around all four sides of your tent canopy valance for a versatile, easy-change messaging option.

- Compatible with our 10' x 10' tent frames
- Artwork is dye sublimated on 400 denier polyester
- Flame-retardant (FR rated for exhibit halls)
- Tent frame and canopy sold separately



10' Tent Valance Wrap

Item #	Description	1	2-5	6-11	12-24
240374	10' Valance Wrap	380.00	370.00	365.00	355.00
USD MSRP (C)					
Product Size	Finished Graphic Size	Product Wt.	Media		
118.75"W x 13"H	118.75"W x 13"H	3 lbs.	400 Denier Polyester		



Hook-and-loop fasteners keep the banner tightly wrapped around the canopy valance.



Add a valance wrap to easily change your message.



Shown on a 10' tent (sold separately)

10' TENT AWNING

This stylish awning can be attached to our Standard tents to add branding space and keep your guests out of the sun.

- Awning cover is constructed of 400 denier polyester
- For use with 10' Standard tent frame
- Artwork is dye sublimated on the top of the awning only
- Tent frame and canopy sold separately



10' Tent Awning

Item #	Description	1	2-5	6-11	12-24
240302	10' Awning	295.00	286.00	278.00	269.00
Kit Includes: Hardware and Awning Cover USD MSRP (C)					
Product Size	Finished Graphic Size	Product Wt.	Media		
117.25"W x 26.5"D	115.75"W x 27"H	6.4 lbs.	400 Denier Polyester		



Easy-to-use thumb screw clamps attach the awning frame to Standard tent frames.



Awning cover attaches to the tent frame using hook-and-loop straps.

WRAP | AWNING
AFTER FINAL PROOF APPROVAL
PRODUCTION LEAD TIME IS
4 OR 7 DAYS

Setup fee: \$20.00(G); no setup fee on orders placed via our website; see page 224 for details.
View current graphic templates, assembly videos and instructions on our website.
See pages 224-226 for additional information that may apply to your order.

Suggested Uses:
Farmers Markets
Sporting Events
Weddings
Carnivals

MODULAR EVENT COUNTER

This counter complements 10' tents perfectly. Create a space for merchandise, or simply use it as a drink rail so your guests have a place to gather.

- Throw is constructed of 400 denier polyester and features a zipper in back
- Countertop supports up to 40 lbs.
- Tent frame and canopy sold separately



Two kits shown with a 10' tent (sold separately)

Modular Event Counter

Item #	Description	1	2-5	6-11	12-24
240371	Kit	550.00	538.00	525.00	508.00
240372	Counter Only	250.00	243.00	235.00	228.00

Kit Includes: Counter and Throw USD MSRP (C)

Product Size	Finished Graphic Size	Product Wt.	Media
113.75"W x 43.5"H x 21.5"D	View Online Template	39.25 lbs.	400 Denier Polyester

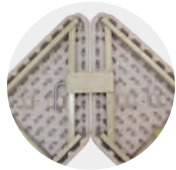

The included bracket lets you connect two counters together at a 90° angle.



A small slit in the throw allows you to connect the counters without removing the throw.

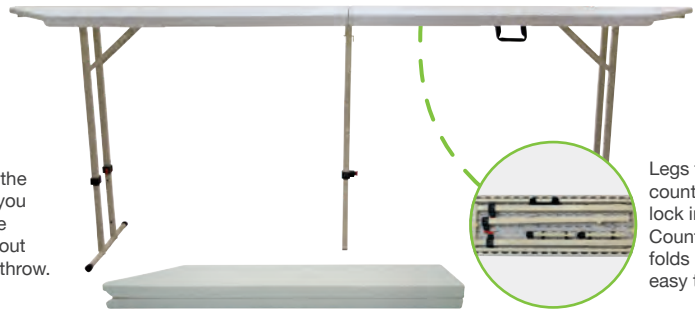

Legs fold into the countertop and lock in place. Countertop folds in half for easy transport.



TENT ACCESSORIES



Tent Accessories

Item #	Description	Product Wt.	1	2-5	6-11	12-24
240085	Square Plastic Water Weight	22 lbs. w/water	43.10	41.80	40.90	39.70
240094	Steel Ballast Weight	11 lbs.	59.00	57.20	56.10	54.30
240112	Tent Sandbag Ballasts (set of 4)	20.6 lbs. w/sand	64.80	62.90	61.60	59.60
240015	Tent Stake Kit	1 lb.	34.50	33.50	32.00	31.00
240768	Heavy-Duty Tent Stake Kit	5 lbs.	112.00	110.00	107.00	105.00
220153	10' Compact Tent Soft Case with Wheels	5 lbs.	113.00	110.00	106.00	103.00
220079	10' Tent Soft Case with Wheels	5.8 lbs.	119.00	113.00	110.00	105.00
220080	15' or 20' Tent Soft Case with Wheels	8.2 lbs.	148.00	143.00	140.00	134.00
220150	10' or 15' Tent Hard Case with Wheels	22 lbs.	324.00	314.00	305.00	295.00

USD MSRP (C)



HARDWARE ONLY LEAD TIME: SHIPS SAME DAY WHEN ORDERED BEFORE 2 PM CENTRAL
Setup fee: \$20.00(G); no setup fee on orders placed via our website; see page 224 for details.
View current graphic templates, assembly videos and instructions on our website.
See pages 224-226 for additional information that may apply to your order.

AFTER FINAL PROOF APPROVAL
PRODUCTION LEAD TIME IS
4 DAYS



1. Value Bag Toss page 126 | 2. Outdoor Event Cooler page 125 | 3 & 4. Floral Sheeting page 120-121

PARADES & EVENTS

When choosing a parade or event product
have you considered...

- **CONTEXT** - What kind of image are you trying to convey at your event?
- **LONGEVITY** - Do you plan to use the product more than once?
- **SIZE** - How large is your event space?
- **AUDIENCE** - How many people are you trying to accommodate?
- **WEATHER** - Will your event be indoors or outdoors?

VICTORY CORPS™ FLOAT KITS

The simplest option for making floats in a flash. Each kit can be customized to match the color scheme of your choice.

- Other kit options available online
- Each kit includes float plans that outline the construction steps
- Magnetic tape, hook and loop and double-sided tape available online
- Kits can be modified to fit other size floats; call for quote



Birthday Float Kit

Item #	Description	Trailer Bed Size	1
285543	Standard Color Kit	7' x 16'	485.00
285544	Metallic Color Kit	7' x 16'	650.00

Kit Includes: 50 yards of Floral Sheeting, 14 lengths of 25' Twist USD MSRP (C) and 6 lengths of 15" x 10' Fringe



Birthday Kit with standard colors (candle props not included)

Seasonal Float Kit

Item #	Description	Trailer Bed Size	1
285550	Standard Color Kit	7' x 16'	340.00
285551	Metallic Color Kit	7' x 16'	460.00

Kit Includes: 50 yards of Floral Sheeting, 4 lengths of 25' Twist USD MSRP (C) and 5 lengths of 15" x 10' Fringe



Seasonal Kit with metallic colors (snowflake prop not included)



3-Tier Platform with standard colors (flags not included)

3-Tier Platform Float kit

Item #	Description	Trailer Bed Size	1
285575	Standard Color Kit	7' x 16'	360.00
285576	Metallic Color Kit	7' x 16'	485.00

Kit Includes: 40 yards of Floral Sheeting, 7 lengths of 25' Twist USD MSRP (C) and 6 lengths of 15" x 10' Fringe



Easy Float Trailer Kit

Item #	Description	Trailer Bed Size	1
285600	Standard Color Kit	6' x 8'	115.00
285601	Metallic Color Kit	6' x 8'	150.00

Kit Includes: 10 yards of Floral Sheeting, 2 lengths of 25' Twist USD MSRP (C) and 4 lengths of 15" x 10' Fringe

Easy Float Truck Kit

Item #	Description	1
285608	Standard Color Kit	48.00
285609	Metallic Color Kit	58.00

Kit Includes: 10 yards of Floral Sheeting, 3 lengths of 25' Twist USD MSRP (C) and 4 lengths of 15" x 10' Fringe



Easy Float Golf Cart Kit

Item #	Description	1
285564	Standard Color Kit	30.00
285565	Metallic Color Kit	35.00

Kit Includes: 2 lengths of 25' Twist and 2 lengths of 15" x 10' Fringe USD MSRP (C)

Easy Float Just Married Kit

Item #	Description	1
285566	Standard Color Kit	50.00
285567	Metallic Color Kit	55.00

Kit Includes: 2 4 mm Corrugated Plastic Just Married Signs, 2 lengths of 25' Twist and 3 lengths of 15" x 10' Fringe USD MSRP (C)

View current assembly videos and instructions on our website. See pages 224-226 for additional information that may apply to your order.

PRODUCTION LEAD TIME IS
5 DAYS



Standard Teal & Metallic Gold Floral Sheeting rolls

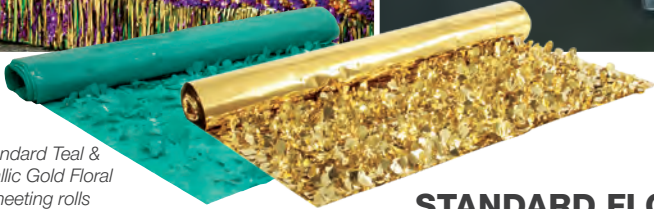

STANDARD FLORAL SHEETING



Light Pink



Light Green



Orchid



Cerise



Grass Green



Purple



Red



Dark Green



Maroon



Orange



Teal



Brown



Sand



Dark Blue

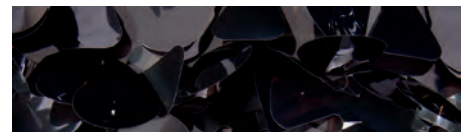

Black



Spanish Gold



Medium Blue



Gray



Yellow



Light Blue



White

VICTORY CORPS™ FLORAL SHEETING

Floral Sheeting is the perfect enhancement for parade floats and parties, offering limitless possibilities for creativity.

- Wrap around parade floats and large objects for a pop of color and sparkle
- Drape it over tables for an attractive runner or table cover
- Use it as a fun backdrop for your next photo op
- Trim into fun shapes for endless creations
- Available in 36" wide rolls
- Standard, metallic, and specialty colors available



Floral Sheeting

Item #	Description	1
285700	5 Yards Standard	42.00
285701	5 Yards Metallic	52.00
See Swatches	5 Yards Specialty	62.00
285500	10 Yards Standard	78.00
285501	10 Yards Metallic	99.00
See Swatches	10 Yards Specialty	110.00

USD MSRP (C)

METALLIC FLORAL SHEETING



Cerise



Red



Orange



Green



Teal



Turquoise



Blue



Purple



Silver



Gold



Copper



Mardi Gras 285703 5 yds / 285503 10 yds



Stars & Stripes 285704 5 yds / 285504 10 yds



Candy Cane 285705 5 yds / 285508 10 yds



Stars 285706 5 yds / 285509 10 yds

SPECIALTY FLORAL SHEETING



Snow 285707 5 yds / 285982 10 yds



Iridescent 285708 5 yds / 285992 10 yds

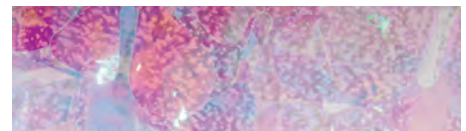

Iridescent Snow 285709 5 yds / 285998 10 yds



Holographic 285702 5 yds / 285502 10 yds



Embossed Gold & Metallic Gold 285715 5 yds / 285985 10 yds



Embossed Gold & Metallic Silver 285713 5 yds / 285983 10 yds



Embossed Gold & Standard Black 285714 5 yds / 285984 10 yds



Embossed Silver & Metallic Silver 285716 5 yds / 285719 10 yds



Embossed Silver & Standard White 285718 5 yds / 285721 10 yds



Close-up of embossed texture.

See pages 224-226 for additional information that may apply to your order.

STANDARD & METALLIC SPECIALTY PRODUCTION LEAD TIME IS
3 1/2 5 DAYS

VICTORY CORPS™ TWIST

Shape or outline objects, accentuate corners or wind around poles. Twist is a big hit at events, and it's the perfect finish for any float.

- 4" diameter
- Comes in 25' lengths
- 2-color twist options available online



Specialty Twist
Embossed Gold
& Metallic Gold

Twist

Item #	Description	1
285505	25' Standard	9.50
285506	25' Metallic	11.50
See Swatches	25' Specialty	12.50

USD MSRP (C)

STANDARD TWIST



METALLIC TWIST



SPECIALTY TWIST

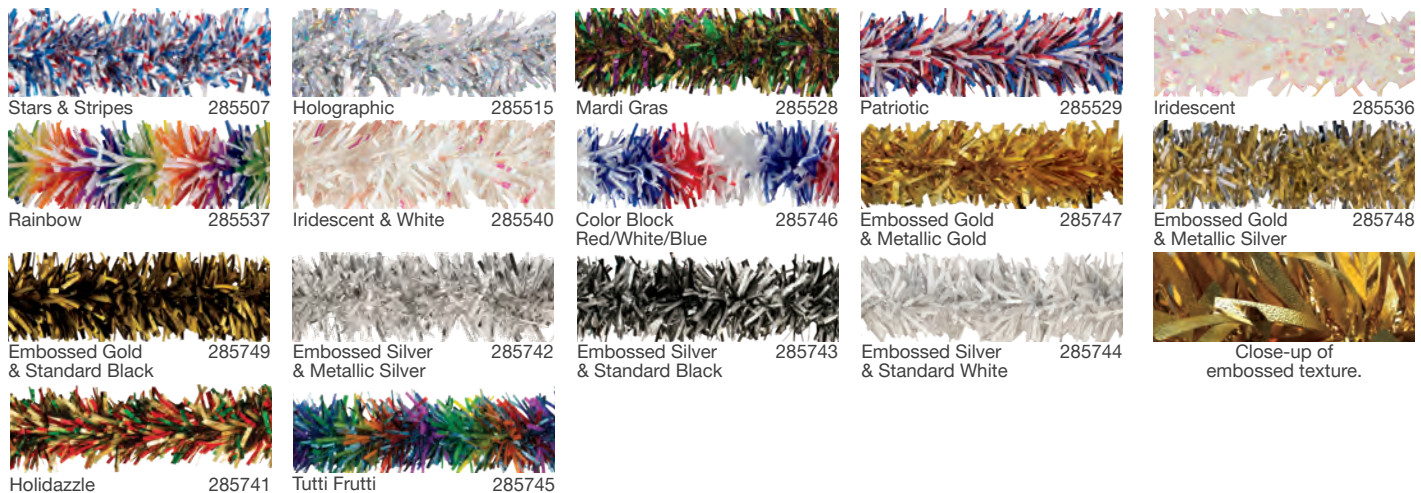

STANDARD & METALLIC | SPECIALTY
3 or 5 DAYS PRODUCTION LEAD TIME IS

See pages 224-226 for additional information that may apply to your order.

VICTORY CORPS™ FRINGE

Fringe is a longstanding parade float essential. It's also an eye-catching addition to any event.

- Use fringe as a table skirt or draped from the ceiling like a garland
- 15" fringe available in 10' lengths
- 30" fringe available in 12' lengths
- 2-color fringe options available online

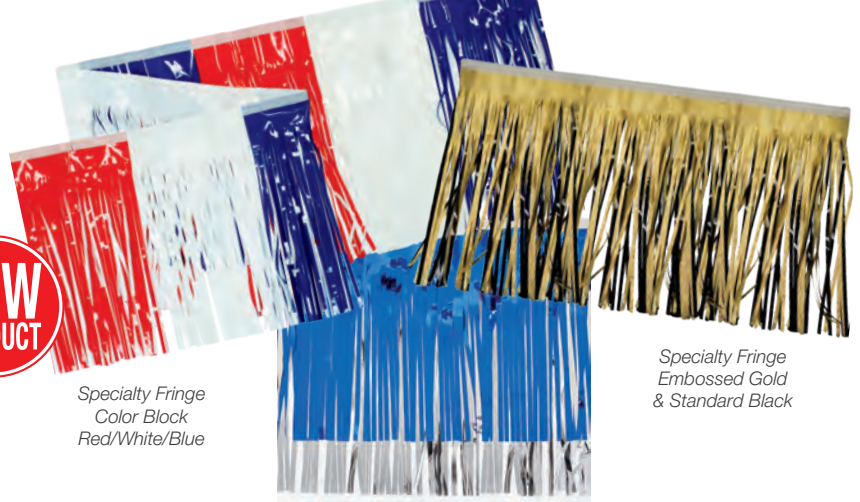

Specialty Fringe
Color Block
Red/White/Blue

Specialty Fringe
Embossed Gold
& Standard Black

Metallic 2-Color Fringe
Blue & Silver (visit website
for 2-color options)

Fringe

Item #	Description	1
285510	15" Standard Fringe	7.00
285511	15" Metallic Fringe	8.00
See Swatches	15" Specialty Fringe	9.50
285538	30" Standard Fringe	35.00
285539	30" Metallic Fringe	37.50

* Limited colors available in 30"

USD MSRP (C)

STANDARD FRINGE

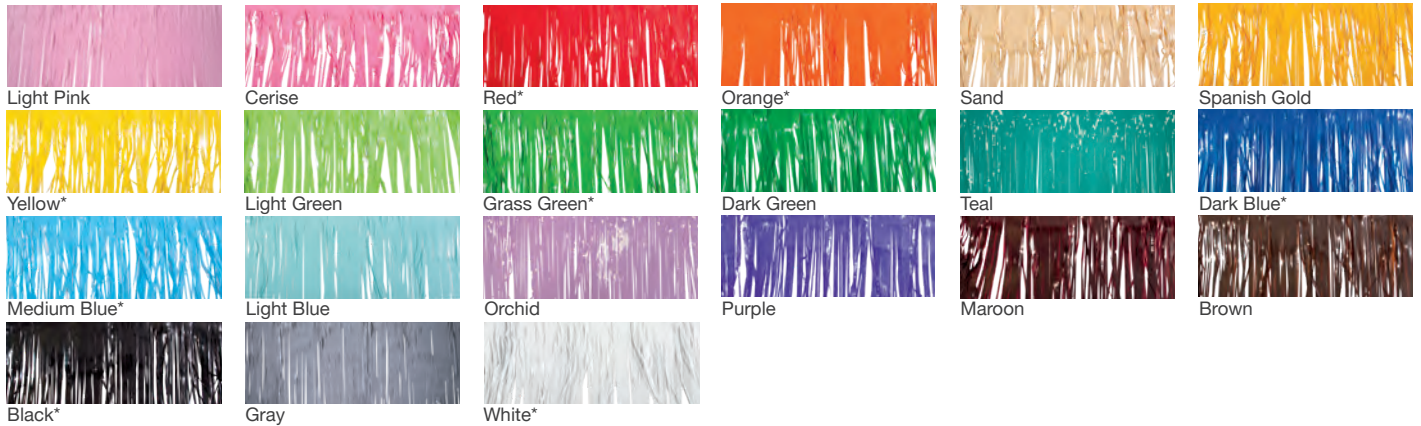

METALLIC FRINGE

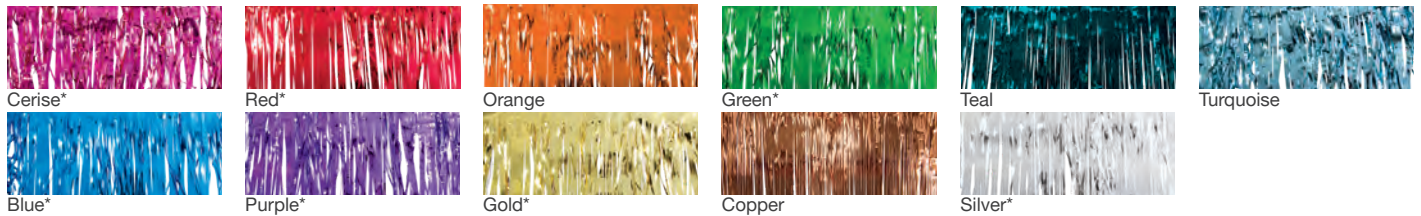

SPECIALTY FRINGE

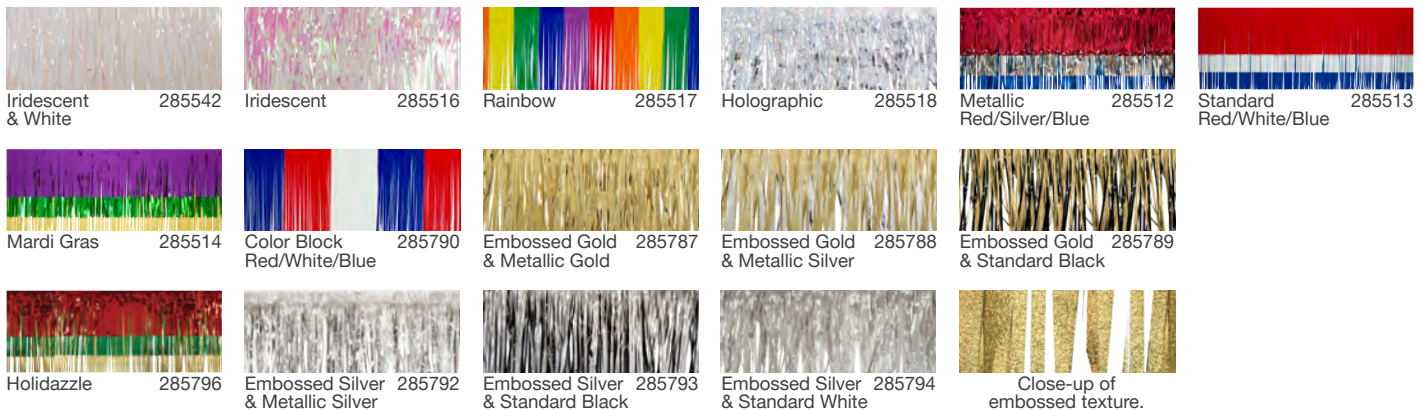

See pages 224-226 for additional information that may apply to your order.

STANDARD & METALLIC | SPECIALTY | PRODUCTION LEAD TIME IS
3 1/2 DAYS

Suggested Uses:
 Weddings
 Fundraisers
 Schools
 Marathons



36" x 46"

SELFIE FRAME

Photo ops have never been more fun! Selfie frames create real-world opportunities for truly viral social media campaigns.

- Constructed of 4 mm corrugated plastic
- Corrugated plastic is much stronger than cardboard, so the frame won't sag or flop
- 36" x 46" size is scored in the back for shipping and features clear tabs to hold it together
- Available single-sided only



Selfie Frame

Item #	Description	Product Wt.	1	2-5	6-11	12-24
271130	18" x 24"	0.25 lb.	14.40	14.10	13.70	13.20
271131	24" X 36"	0.5 lb.	21.70	21.30	20.60	20.00
271132	36" X 46"	1 lb.	38.00	37.20	36.10	35.00

USD MSRP (C)



36" x 46" size is scored in back so it can be folded for shipping, and it features clear tabs to hold it together.



Sail Sign



X Banner



BACKPACK BANNERS

From stadiums to the streets, these backpack banners let you create advertisements that walk around so they can always be where the action is.

- Comfortable, reinforced straps
- Two styles to choose from



Backpack Banners

Item #	Description	1	2-5	6-11	12-24
190920	Backpack Sail Sign Single-Sided Kit	189.60	183.70	174.60	168.70
190922	Backpack Sail Sign Double-Sided Kit	242.00	234.50	222.90	215.40
190925	Backpack X Banner Single-Sided Kit	168.40	163.10	155.10	149.80

Kit Includes: Hardware, Backpack and Banner
 USD MSRP (C)

Description	Product Size	Finished Graphic Size	Product Wt.	Media
Sail Sign	12"W x 72"H x 23"D	View Online Template	2.25 lbs.	Super Poly Knit Fabric
X Banner	19.75"W x 48.75"H x 12.5"D	19.5"W x 47.25"H	3.5 lbs.	Titan™ 13 oz. Smooth Scrim Vinyl

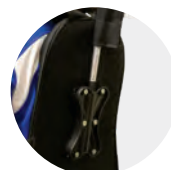

Poles are inserted into the backpack for quick installation.



Side pockets on the backpack hold standard water bottles.

X BANNER | SELFIE FRAME | SAIL SIGN
2 OR 3 OR 4 DAYS
 AFTER FINAL PROOF APPROVAL
 PRODUCTION LEAD TIME IS

Setup fee: \$20.00(G); no setup fee on orders placed via our website; see page 224 for details.
 View current graphic templates, assembly videos and instructions on our website.
 See pages 224-226 for additional information that may apply to your order.

Suggested Uses:
 Giveaways
 Store Promotions
 Parties
 Company Events

SPIN 'N WIN PRIZE WHEEL & PRIZE WHEEL PLUS

Give your next trade show or event a creative spin.

- Powder-coated steel legs
- A plastic clicker makes a ticking sound as the wheel spins
- Central disc panel attaches magnetically and remains stationary when the wheel spins
- All graphic panels can be custom printed with your design
- Both prize wheels include twelve prize panels and central disc panel
- Prize Wheel Plus includes additional top and bottom graphic panels (US Patent #9981179)



Spin 'N Win Prize Wheels

Item #	Description	1	2-5	6-11	12-24
280104	Spin 'N Win Prize Wheel Kit	565.00	560.00	555.00	550.00
280084	Spin 'N Win Prize Wheel Plus Kit	666.40	648.10	631.50	610.30
Kit Includes: Hardware, Graphic Panels and Soft Carry Case		USD MSRP (C)			

Description	Product Size	Finished Graphic Size	Product Wt.	Graphic Media
Prize Wheel	31.25"W x 40.75"-72"H x 16"-31"D	View Online Template	16.5 lbs.	Titan™ No-Curl Laminated Media
Prize Wheel Plus	Tabletop: 31.75"W x 43.5"H x 16.5"D Floor: 31.75"W x 76"H x 30.5"D	View Online Template	18 lbs.	Styrene



Spin 'N Win Prize Wheel



Spin 'N Win Prize Wheel Plus



Prize wheels can be used on tabletops or as a standalone display with the legs extended.



Prize Wheel: Graphic panels and center plate panel can be printed using a desktop printer.



Prize Wheel Plus: Graphic panels feature tabs that slide into grooves for easy installation.

OUTDOOR EVENT COOLER

Keep drinks cold and your branding hot with this customizable cooler.

- Can be used indoors or outdoors
- Molded insulation keeps contents cold
- Clear lid lets you see what's inside
- Graphic is printed on Titan™ no-curl laminated media
- Holds up to 40 lbs. of ice and 48 standard 12 oz. cans



Outdoor Event Cooler

Item #	Description	1	2-5	6-11	12-24
280240	Kit	405.00	397.00	393.00	385.00
Kit Includes: Hardware and Graphic Wrap		USD MSRP (C)			

Product Size	Finished Graphic Size	Product Wt.	Media
22.125"W x 35"H x 25.125"D	View Online Template	24.25 lbs.	Titan™ No-Curl Laminated Media



Single pivot lid can be opened and closed with one hand.



Two wheels and molded handles for mobility.

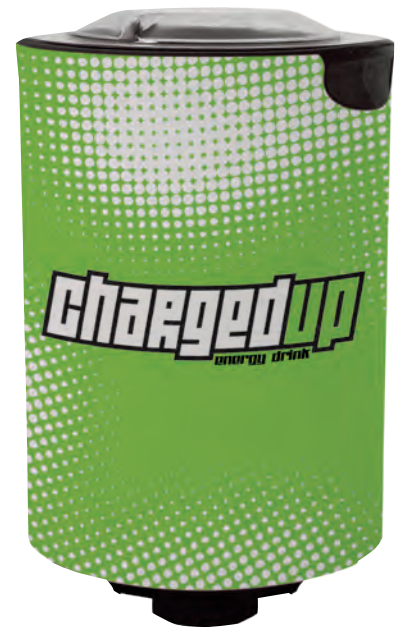

Setup fee: \$20.00(G); no setup fee on orders placed via our website; see page 224 for details.
 View current graphic templates, assembly videos and instructions on our website.
 See pages 224-226 for additional information that may apply to your order.

PRIZE WHEELS COOLER
24 DAYS
 AFTER FINAL PROOF APPROVAL
 PRODUCTION LEAD TIME IS

Suggested Uses:
Corporate Events
Tailgating
Fundraisers
Restaurants



BAG TOSS GAME

Toss in some friendly competition at your next outdoor event with this customizable game.

- Two game boards clasp together into a single unit that can be easily transported using the convenient carry handle
- Durable plastic construction prevents rust and splinters
- Included rope acts as a distance regulator
- Hinged legs fold out to prop the game boards up at an angle
- 90-day warranty on graphic panels



Bag Toss Game

Item #	Description	1	2-5	6-11	12-24
280310	Kit	238.00	233.00	231.00	226.00
Kit Includes: Hardware, 8 Bean Bags and 2 Graphic Panels		USD MSRP (C)			

Product Size	Finished Graphic Size	Product Wt.	Media
Folded: 21.5"W x 2.75"H x 33.125"D (1) Open: 21.5"W x 10.5"H x 32.75"D	19.5"W x 29.875"H (View Online Template)	21.5 lbs.	Titan™ No-Curl Laminated Media



Built-in score keepers slide up and down the edges of the board.



Bean bags can be stored inside plastic molded pockets so they don't get left behind.



VALUE BAG TOSS GAME

The Value Bag Toss game packs a whole lot of fun into a budget-friendly package.

- Two game boards clasp together into a single unit that can be easily transported using the convenient carry handle
- Game boards are constructed of sturdy nylon polymer
- Detachable legs keep the game boards propped up at an angle
- Artwork is printed on a repositionable, adhesive-backed media with a textured finish
- 90-day warranty on graphic decals



Value Bag Toss Game

Item #	Description	1	2-5	6-11	12-24
280130	Kit	161.00	159.00	156.00	154.00
Kit Includes: Hardware, 8 Bean Bags and 2 Decals		USD MSRP (C)			

Product Size	Finished Graphic Size	Product Wt.	Media
Folded: 24.75"W x 3.125"H x 33.375"D (1) Open: 21.5"W x 10.125"H x 33.625"D	19.875"W x 31.6875"H (View Online Template)	15.5 lbs.	Surface Grip



Removable decals come applied to the game board.



Bean bags can be stored inside elastic pouches so they don't get left behind.



Sliding scorekeeper on the legs counts from 00 to 21.

3 DAYS
AFTER FINAL PROOF APPROVAL
PRODUCTION LEAD TIME IS

Setup fee: \$20.00(G); no setup fee on orders placed via our website; see page 224 for details.
View current graphic templates, assembly videos and instructions on our website.
See pages 224-226 for additional information that may apply to your order.

Suggested Uses:

- Offices
- Trade Shows
- Charities
- Festivals

PRIZE PUTT

Let your visitors show off their golf skills to win prizes. This mini golf game will make you the talk of any trade show or event.

- Game board is constructed of ultra-durable ABS plastic
- Game board is two separate pieces that attach together using hook-and-loop fasteners
- 90-day warranty on decals and card inserts



Prize Putt

Item #	Description	1	2-5	6-11	12-24
280120	Kit	648.00	629.00	616.00	602.00
Kit Includes: Hardware, Putter, 3 Golf Balls, Turf Mat, Card Inserts and Decals		USD MSRP (C)			

Product Size	Finished Graphic Size	Product Wt.	Media
44.875"W x 7.5"H x 68.75"D	View Online Template	20.5 lbs.	Surface Grip



Graphic card inserts simply slide into slots on the game board.

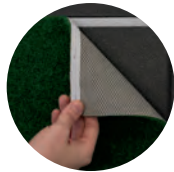

Included turf mat attaches using hook-and-loop fasteners.



Graphic decals install by removing the adhesive backing and adhering them to the game board.

Add-On



Prize Putt Soft Case

Item #	1	2-5	6-11	12-24
220159	135.00	131.00	127.00	123.00
USD MSRP (C)				

Suggested Uses:

- Trade Shows
- Point-of-Purchase
- Table Tops
- Meetings

PRIZE DROP GAME

Crowds will line up for the chance to plink their way to prizes.

- Easy setup; simply place it on a table, insert your prize cards and it's ready to go
- Frame is constructed of tough ABS plastic
- Powder-coated steel support leg



Prize Drop Game

Item #	Description	1	2-5	6-11	12-24
280105	Kit	410.00	407.00	405.00	402.00
Kit Includes: Hardware, 3 Pucks, Prize Cards and Header Insert		USD MSRP (C)			

Product Size	Finished Graphic Size	Product Wt.	Graphic Media
Folded: 24"W x 34.5"H x 21.75"D Open: 24"W x 36.25"H x 2.25"D	View Online Template	7 lbs.	Titan™ No-Curl Laminated Media



Replacement prize cards and header insert can be printed using a desktop printer.



Includes three pucks

Setup fee: \$20.00(G); no setup fee on orders placed via our website; see page 224 for details. View current graphic templates, assembly videos and instructions on our website. See pages 224-226 for additional information that may apply to your order.

PRIZE DROP | PRIZE PUTT
AFTER FINAL PROOF APPROVAL
PRODUCTION LEAD TIME IS
2 3 DAYS



1. Pedestal Sign page 142 | 2. Storm Mat page 150 | 3. Signicade Deluxe page 130

SIGNAGE

When choosing signage **have you considered...**

- **LOCATION** - Will your sign be used indoors or out?
- **LONGEVITY** - How long will your sign be displayed?
- **FLEXIBILITY** - Will your message be permanent, or will it change frequently?
- **TRANSPORT** - Will your sign be stationary, or will you be transporting it from place to place?

SIGNAGE COMPARISON CHART

★ = Best Sellers	PG	EASY TO CHANGE SIGN	TWO-SIDED	SUBSTRATE	OUTDOOR USE	WEIGHT	
OUTDOOR	NEW! Parking Pal	137	✓	✓	Reflective Media	✓	13 lbs.
	Simpo Square A-Frame	130	✓	✓	4 mm Corrugated Plastic	✓	6.25 lbs.
	Minicade A-Frame	130	✓	✓	4 mm Corrugated Plastic	✓	7.5 lbs.
	Simpo Sign II A-Frame ★	130	✓	✓	4 mm Corrugated Plastic	✓	10.5 lbs.
	Signicade Deluxe Chalkboard A-Frame	130	✓	✓	Chalkboard	✓	25 lbs.
	Signicade Deluxe A-Frame ★	130	✓	✓	4 mm Corrugated Plastic	✓	21 lbs.
	Narrowcade A-Frame	131	✓	✓	4 mm Corrugated Plastic	✓	8.5 lbs.
	Signicade A-Frame	131	✓	✓	4 mm Corrugated Plastic	✓	20 lbs.
	Metropolitan Signicade A-Frame	131	✓	✓	4 mm Corrugated Plastic	✓	27.75 lbs.
	Deluxe Wood A-Frame	132	✓	✓	Chalkboard with Surface Grip Decal	Short-Term	18-29.8 lbs.
	Economy Wood A-Frame	132	✓	✓	Chalkboard with Surface Grip Decal	Short-Term	8.5 lbs.
	Quick Change Wood A-Frame	133	✓	✓	Chalkboard with Surface Grip Decal	Short-Term	12.9-18.3 lbs.
	Horizontal A-Frame	135	✓	✓	Titan™ 13 oz. Scrim Vinyl	✓	11-18 lbs.
	Superstrong Angle Iron A-Frame	135	✓	✓	4 mm Corrugated Plastic	✓	6.5-13.5 lbs.
	EuroFit A-Frame	136	✓	✓	Polyester Knit	Short-Term	11-22 lbs.
	Twist-Up Oval A-Frame	136	✓	✓	Polyester Knit	✓	8.25 lbs.
	NEW! Sunrise Lawn Sign	137	✓	✓	Super Poly Knit Fabric	✓	2.3 lbs.
	Outdoor Flex Sign ★	138	✓	✓	Titan™ 10 oz. Scrim Vinyl	✓	27 lbs.
	Outdoor Flex Sign with Ballast Base ★	138	✓	✓	Titan™ 10 oz. Scrim Vinyl	✓	26 lbs.
	Corrugated Plastic Sign	139	✓	✓	4 mm Corrugated Plastic	✓	0.5-1 lb.
	Outdoor Rigid Base Sign	139	✓	✓	4 mm-10 mm Corrugated Plastic	✓	5.25-6.5 lbs.
	EuroFit Barrier	140	✓	✓	Polyester Knit	Short-Term	27-28.4 lbs.
	Barricade Cover	140	✓	✓	Two-Way Stretch Fabric Titan™ 18 oz. Opaque Scrim Vinyl	✓	1.8-5.4 lbs.
	FrameWorx Flex	141	✓	✓	Fabric Mesh	✓	27.5 lbs.
	EuroFit Ballast Base	141	✓	✓	Polyester Knit	Short-Term	8 lbs.
Door Wrap	148	✓	✓	Two-Way Stretch Fabric	Short-Term	1.25-1.5 lbs.	
Outdoor Surface Tac	149	✓	✓	Adhesive Aluminum Foil-Based Media	✓	0.8-3.8 lbs.	
Storm Mat ★	150	✓	✓	Polyester Carpeting with Rubber Backing	✓	4-10 lbs.	
INDOOR	Uptown A-Frame	134	✓	✓	Rigid PVC Board	✓	15.5-24.25 lbs.
	Uptown Accent A-Frame	134	✓	✓	Rigid PVC Board	✓	30.5 lbs.
	Base-X Sign	142	✓	✓	Foamcore	✓	7.25-8.25 lbs.
	Single Sign	142	✓	✓	4 mm Corrugated Plastic	✓	13 lbs.
	Flat Base Sign	142	✓	✓	4 mm Corrugated Plastic	✓	13.5 lbs.
	Pedestal Snap Frame Sign	142	✓	✓	Titan™ Polypropylene Media	✓	5.5 lbs.
	Pedestal Sign	142	✓	✓	4 mm Corrugated Plastic	✓	14.5 lbs.
	NEW! Impress Sign	143	✓	✓	Polyester Knit	✓	14.25 lbs.
	Front - Load Snap Frame	144	✓	✓	Titan™ Polypropylene Media	✓	1.75-4.5 lbs.
	Top-Load Frame	144	✓	✓	Titan™ Polypropylene Media	✓	1.5-3.5 lbs.
	Crystal Edge Display	145	✓	✓	Backlit Media	✓	5-13.7 lbs.
	LED Light Box	145	✓	✓	Backlit Media	✓	8.5-14 lbs.
	NEW! Canvas Signboard	146	✓	✓	Canvas Fabric	✓	1.5-8 lbs.
	NEW! Glossy Aluminum Signboard	147	✓	✓	Aluminum	✓	0.2-4 lbs.
	Countertop Mat	148	✓	✓	PVC Foam w/PVC Coated Polyester Woven Fabric	✓	1.3-1.8 lbs. (set of 6)
	Indoor Surface Grip	149	✓	✓	Adhesive Matte Vinyl with Fabric Backing	✓	0.6-2.4 lbs.
	Floor Hugger Mat ★	150	✓	✓	Nylon Yarn with Rubber Backing	✓	8-16 lbs.
	NEW! Marketing Mat	151	✓	✓	40 mil Vinyl	✓	.15-0.6 lb.
Floor Decor	151	✓	✓	PVC Foam w/PVC Coated Polyester Woven Fabric	✓	1.6-22 lbs.	



SIGNAGE SUBSTRATES

RIGID



- 4 mm & 10 mm Corrugated Plastic
- Foamcore
- Rigid PVC Board
- Chalkboard
- Aluminum

BANNER



- Titan™ Polypropylene Media
- Titan™ 10 oz. Scrim Vinyl
- Titan™ 13 oz. Scrim Vinyl
- Titan™ 18 oz. Opaque Scrim Vinyl
- Reflective Media
- Backlit Media

FABRIC



- Two-Way Stretch Fabric
- Super Poly Knit Fabric
- Polyester Knit
- Fabric Mesh
- Canvas Fabric

MAT



- PVC Foam w/PVC Coated Polyester Woven Fabric
- Nylon Yarn with Rubber
- Polyester carpeting with rubber backing
- 40 mil Vinyl

DECAL



- Adhesive Matte Vinyl with Fabric Backing
- Adhesive Aluminum Foil-Based Media

SIGNICADE AND SIMPO A-FRAMES

With multiple sizes to choose from, these A-frames fit a variety of spaces.

- Maintenance-free and weather-resistant
- Folds flat for transport or storage



Chalkboard lets you display personalized, hand-written messages (chalk markers recommended; not included).



Simpo Square

Minicade

Simpo Sign II

Signicade Deluxe Chalkboard

Simpo Square A-Frame

Item #	Description	1	2-5	6-11	12-24
210274	Single-Sided Kit	110.00	108.00	104.00	102.00
271094	Single-Sided Signboard Only (1)	13.10	12.80	12.40	12.10
210275	Double-Sided Kit	119.00	117.00	113.00	110.00
271095	Double-Sided Signboard Only (1)	17.40	17.10	16.50	16.00

Kit Includes: Hardware and 2 Single- or Double-Sided Signboards USD MSRP (C)

Product Size	Finished Graphic Size	Product Wt.	Media
22"W x 24.625"H x 21"D	20"W x 20"H	6.25 lbs.	4 mm Corrugated Plastic

Frame Color White

Minicade A-Frame

Item #	Description	1	2-5	6-11	12-24
210262	Minicade Kit	132.00	128.00	122.00	118.00
271090	Single-Sided Signboard Only (1)	16.00	15.70	15.20	14.70

Kit Includes: Hardware, 2 Single-Sided Signboards and 2 12" Strips of Hook and Loop USD MSRP (C)

Product Size	Finished Graphic Size	Product Wt.	Media
13"W x 33.75"H x 25"D	12"W x 24"H	7.5 lbs.	4 mm Corrugated Plastic

Frame Color White

Simpo Sign II A-Frame

Item #	Description	1	2-5	6-11	12-24
210091	Single-Sided Kit	206.00	200.00	191.00	185.00
271049	Single-Sided Signboard Only (1)	21.70	21.30	20.60	20.00
210092	Double-Sided Kit	216.00	210.00	201.00	195.00
271050	Double-Sided Signboard Only (1)	27.15	26.60	25.80	25.00

Kit Includes: Hardware and 2 Single- or Double-Sided Signboards USD MSRP (C)

Product Size	Finished Graphic Size	Product Wt.	Media
24"W x 36.75"H x 21.5"D	22"W x 28"H	10.5 lbs.	4 mm Corrugated Plastic

Frame Color White

Signicade Deluxe A-Frame

Item #	Description	1	2-5	6-11	12-24
210121	Single-Sided Kit	189.00	183.00	175.00	169.00
271072	Single-Sided Signboard Only (1)	21.30	20.90	20.20	19.60
210122	Double-Sided Kit	202.00	196.00	190.00	184.00
271073	Double-Sided Signboard Only (1)	27.70	27.10	26.30	25.50
210280	Chalkboard* Kit	241.00	235.00	224.00	218.00
271098	Chalkboard* Only (1)	48.00	47.00	45.60	44.20

Kit Includes: Black or White Hardware and 2 Single- or Double-Sided Signboards USD MSRP (C)
*Chalkboard is single-sided and unimprinted

Product Size	Finished Graphic Size	Product Wt. (Coro / Chalkboard)	Media
27"W x 38.5"H x 19"D	24"W x 36"H	21 lbs. / 25 lbs.	4 mm Corrugated Plastic Chalkboard Laminated Rigid PVC Board

Frame Colors Black White

Features & Benefits



Plastic base won't rust, making it great for outdoor use.



Convenient molded handle makes it easy to move.



Frames can be filled with water or sand for stability.

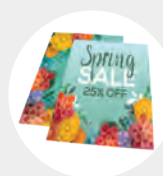

Signboards are easy to swap out to accommodate frequent message changes.

AFTER FINAL PROOF APPROVAL
PRODUCTION LEAD TIME IS
2 DAYS

Setup fee: \$20.00(G); no setup fee on orders placed via our website; see page 224 for details.
View current graphic templates, assembly videos and instructions on our website.
See pages 224-226 for additional information that may apply to your order.

Suggested Uses:
 Coffee Shops
 Cafes
 Sidewalk Sales
 Restaurants

Rider panel (sold separately)



SIGNAGE

Signicade Deluxe

Narrowcade

Signicade

Signicade Metropolitan

Side panel (sold separately)



Wheels make it easy to move.

Narrowcade A-Frame

Item #	Description	1	2-5	6-11	12-24
210260	Narrowcade Kit	137.00	133.00	127.00	122.00
271090	Single-Sided Signboard Only (1)	16.00	15.70	15.20	14.70
Kit Includes: Hardware, 2 Single-Sided Signboards and 2 12" Strips of Hook and Loop		USD MSRP (C)			
Product Size	Finished Graphic Size	Product Wt.	Media		
13"W x 39"H x 44"D	12"W x 24"H	8.5 lbs.	4 mm Corrugated Plastic		

Frame Color White

Signicade A-Frame

Item #	Description	1	2-5	6-11	12-24
210133	Kit	172.00	166.00	158.00	155.00
271084	Single-Sided Signboard Only (1)	21.30	20.90	20.20	19.60
Kit Includes: Orange, Yellow or White Hardware, 2 Single-Sided Signboards and 2 24" Strips of Hook and Loop		USD MSRP (C)			
Product Size	Finished Graphic Size	Product Wt.	Media		
24.5"W x 42"H x 31"D	24"W x 36"H	20 lbs.	4 mm Corrugated Plastic		

Frame Colors Orange Yellow White

Signicade Metropolitan A-Frame

Item #	Description	1	2-5	6-11	12-24
210270	Single-Sided Kit	255.00	246.00	235.00	227.00
271086	Single-Sided Signboard Only (1)	21.30	20.90	20.20	19.60
210271	Double-Sided Kit	267.00	258.00	247.00	238.00
271087	Double-Sided Signboard Only (1)	27.70	27.10	26.30	25.50
271091	Single-Sided Side Panel	21.30	20.90	20.20	19.60
271092	Double-Sided Side Panel	26.70	26.20	25.40	24.60
271093	Double-Sided Rider Panel	11.20	11.00	10.60	10.30
Kit Includes: Black or White Hardware and 2 Single- or Double-Sided Signboards		USD MSRP (C)			
Side and rider panels sold separately.					
Product Size	Finished Graphic Size	Product Wt.	Media		
26.75"W x 43.5"H x 28"D	Main Graphic: 24"W x 36"H Side Graphic: 3.875"W (top), 22.5"W (bottom) x 29.5"H Rider Graphic: 24"W x 11"H	27.75 lbs.	4 mm Corrugated Plastic		

Frame Colors Black White

Double-Sided Signboards - One Signboard, Two Sides.

Double-sided signboards have your artwork printed on both sides, making each signboard reversible.

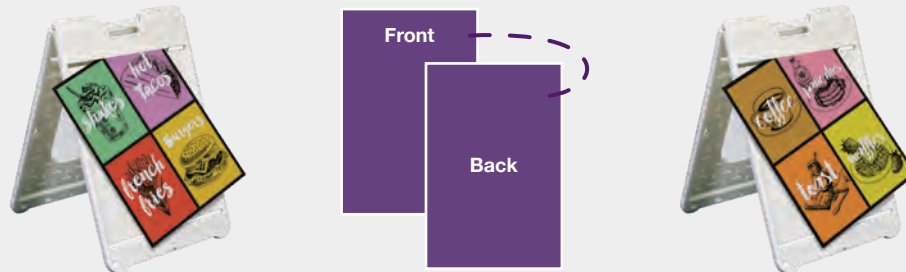

Double-sided signboards available for Simpo Square, Simpo Sign II, Signicade Deluxe and Signicade Metropolitan.

Setup fee: \$20.00(G); no setup fee on orders placed via our website; see page 224 for details.
 View current graphic templates, assembly videos and instructions on our website.
 See pages 224-226 for additional information that may apply to your order.

AFTER FINAL PROOF APPROVAL
 PRODUCTION LEAD TIME IS
2DAYS



46" shown in light brown



32" shown in espresso

DELUXE WOOD A-FRAME

This A-frame gives you an upscale way to display daily specials, menu items, messages and creative artwork.

- Available in two sizes and two colors
- Frame is constructed of beech wood and has butted corners
- Chalkboard are constructed of polypropylene
- A steel chain prevents the A-frame from opening all the way so it remains stable
- Recommended for indoor or limited outdoor use
- Wood A-frames used outdoors have a 30-day warranty; wood A-frames used indoors have a 1-year warranty



Deluxe Wood Chalkboard A-Frame

Item #	Description	1	2-5	6-11	12-24
263370	32" Kit	186.00	180.00	172.00	165.00
263373	46" Kit	247.00	238.00	228.00	219.00
Kit Includes: Espresso or Light Brown Hardware and 2 Header Decals					USD MSRP (C)

Description	Product Size	Finished Graphic Size	Product Wt.	Media
32"	21.625"W x 32.5"H x 19.125"D	18.45"W x 6"H	18 lbs.	Surface Grip
46"	26.75"W x 46"H x 24.375"D	23.5"W x 7"H	29.8 lbs.	Surface Grip



Chalkboard inserts slide into grooves in the top of the frame.

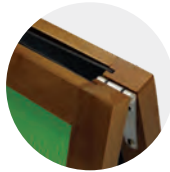

Heavy-duty galvanized steel hinges let you fold the frame flat for easy storage.



Artwork is printed on an easily removable Surface Grip decal that comes applied to the chalkboard.



Chalkboard lets you display personalized, handwritten messages (chalk markers recommended, not included).



Espresso



Light brown

ECONOMY WOOD A-FRAME

This A-frame is a great option if you're looking for a chalkboard sign on a budget.

- Frame is constructed of lightweight pine wood and has butted corners
- Chalkboard inserts are constructed of polypropylene and cannot be removed
- Recommended for indoor or limited outdoor use
- Wood A-frames used outdoors have a 30-day warranty; wood A-frames used indoors have a 1-year warranty



Economy Wood Chalkboard A-Frame

Item #	Description	1	2-5	6-11	12-24
263390	Kit	128.00	124.00	118.00	114.00
Kit Includes: Espresso or Light Brown Hardware and 2 Header Decals					USD MSRP (C)

Product Size	Finished Graphic Size	Product Wt.	Media
21.625"W x 32.5"H x 18.5"D	18.45"W x 5"H	8.5 lbs.	Surface Grip



A steel chain prevents the A-frame from opening all the way so it remains stable.



Metal hinges let you fold the frame flat for easy storage.



Artwork is printed on an easily removable Surface Grip decal that comes applied to the chalkboard.

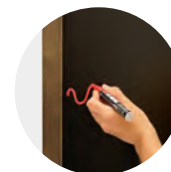

Chalkboard lets you display personalized, handwritten messages (chalk markers recommended, not included).

AFTER FINAL PROOF APPROVAL
PRODUCTION LEAD TIME IS
2 DAYS

Setup fee: \$20.00(G); no setup fee on orders placed via our website; see page 224 for details.
View current graphic templates, assembly videos and instructions on our website.
See pages 224-226 for additional information that may apply to your order.



Chalkboard lets you display personalized, handwritten messages (chalk markers recommended, not included).



Galvanized steel hinges let you fold the frame flat for easy storage.



Artwork is printed on an easily removable Surface Grip decal that comes applied to the chalkboard.



Chalkboard inserts slide into grooves in the top of the frame.



34" shown in espresso

48" shown in light brown



A steel chain prevents the A-frame from opening all the way so it remains stable.

QUICK CHANGE WOOD A-FRAME

Swap out your chalkboards in a flash with this easy change A-frame.

- Available in two sizes and two colors
- Frame is constructed of beech wood
- Chalkboard is constructed of polypropylene
- Recommended for indoor or limited outdoor use
- Wood A-frames used outdoors have a 30-day warranty; wood A-frames used indoors have a 1-year warranty



Quick Change Wood Chalkboard A-Frame

Item #	Description	1	2-5	6-11	12-24
263380	34" Kit	211.00	204.00	195.00	187.00
263383	48" Kit	283.00	273.00	261.00	251.00

Kit Includes: Espresso or Light Brown Hardware and 2 Header Decals USD MSRP (C)

Description	Product Size	Finished Graphic Size	Product Wt.	Media
34"	21.625"W x 34.5"H x 19.5"D	18.375"W x 5"H (View online template)	12.9 lbs.	Surface Grip
48"	26.75"W x 48"H x 24.5"D	23.625"W x 7"H (View online template)	18.3 lbs.	Surface Grip



Setup fee: \$20.00(G); no setup fee on orders placed via our website; see page 224 for details. View current graphic templates, assembly videos and instructions on our website. See pages 224-226 for additional information that may apply to your order.

AFTER FINAL PROOF APPROVAL
PRODUCTION LEAD TIME IS
2DAYS



UPTOWN A-FRAME

This A-frame presents your message with a touch of class.

- Recommended for indoor use
- Frame constructed of high-grade aluminum with a silver matte finish
- Foot pegs prevent the A-frame from scratching floors or slipping



Uptown A-Frame

Item #	Description	1	2-5	6-11	12-24
263190	40" Kit	270.00	262.00	250.00	242.00
263192	45" Kit	298.00	289.00	276.00	267.00
Kit Includes: Hardware, 2 Single-Sided Signboards and 1 Double-Sided Rider Panel (artwork can be different for each side)					USD MSRP (C)
Description	Product Size	Finished Graphic Size	Product Wt.	Media	
40"	18.75"W x 40.875"H x 29"D	Signboard: 16.5"W x 23.375"H Rider Panel: 18.2"W x 7"H	15.5 lbs.	Rigid PVC Board	
45"	26.625"W x 45.375"H x 32.625"D	Signboard: 23.375"W x 33"H Rider Panel: 25.1"W x 7"H	24.25 lbs.	Rigid PVC Board	



Edges flip open so swapping out signboards is easy.

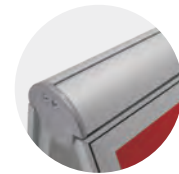

Rider panel simply slides into a slot in the top of the frame and is secured when the frame is fully extended.

Suggested Uses:

Fairs
Charity Events
Sporting Events
Clinics

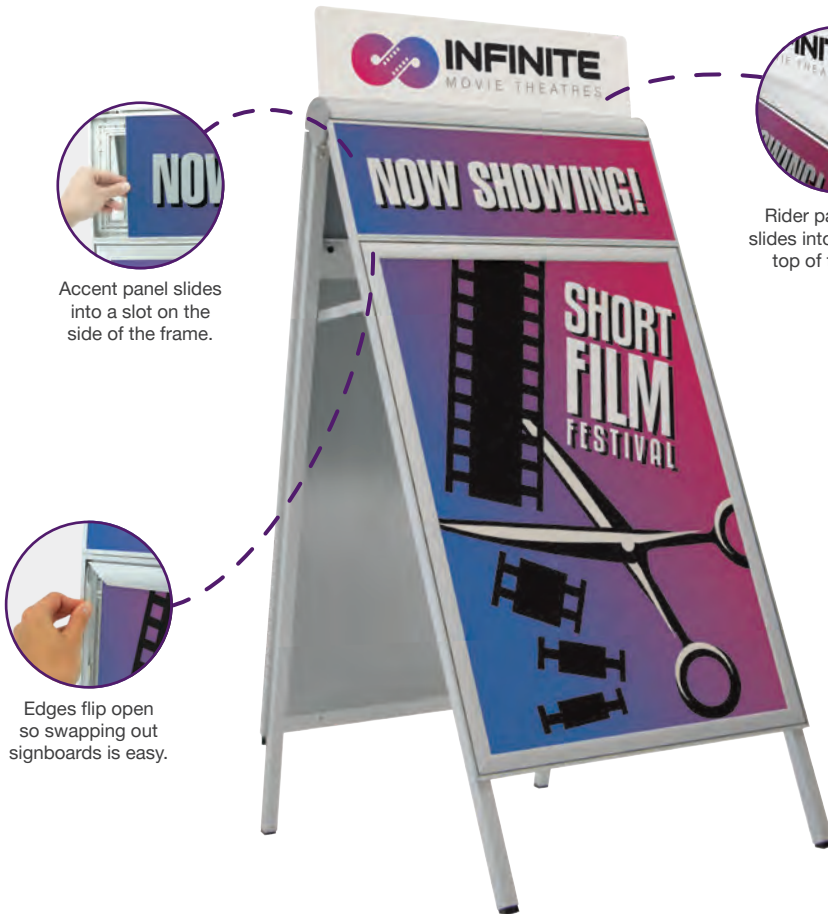

Accent panel slides into a slot on the side of the frame.



Rider panel simply slides into a slot in the top of the frame.



Edges flip open so swapping out signboards is easy.

UPTOWN ACCENT A-FRAME

With so many ways to display, the Uptown Accent is an impressively versatile A-frame.

- Recommended for indoor use
- Frame constructed of high-grade aluminum with a silver matte finish
- Foot pegs prevent the A-frame from scratching floors or slipping



Uptown Accent A-Frame

Item #	Description	1	2-5	6-11	12-24
263196	Kit	324.00	315.00	300.00	291.00
Kit Includes: Hardware, 2 Single-Sided Signboards, 2 Single-Sided Accent Panels and 1 Double-Sided Rider Panel (artwork can be different for each side)					USD MSRP (C)
Product Size	Finished Graphic Size	Product Wt.	Media		
25.625"W x 50.875"H x 35.75"D	Signboard: 23.375"W x 33"H Accent Panel: 25.25"W x 8.25"H Rider Panel: 25.1"W x 7"H	30.5 lbs.	Rigid PVC Board		

AFTER FINAL PROOF APPROVAL
PRODUCTION LEAD TIME IS
2 DAYS

Setup fee: \$20.00(G); no setup fee on orders placed via our website; see page 224 for details.
View current graphic templates, assembly videos and instructions on our website.
See pages 224-226 for additional information that may apply to your order.



HORIZONTAL A-FRAME

This aluminum A-frame is built to handle outdoor conditions.

- Lightweight and portable
- Artwork is printed on Titan™ 13 oz. scrim vinyl
- Banners used outdoors have a 90-day warranty; banners used indoors have a 1-year warranty

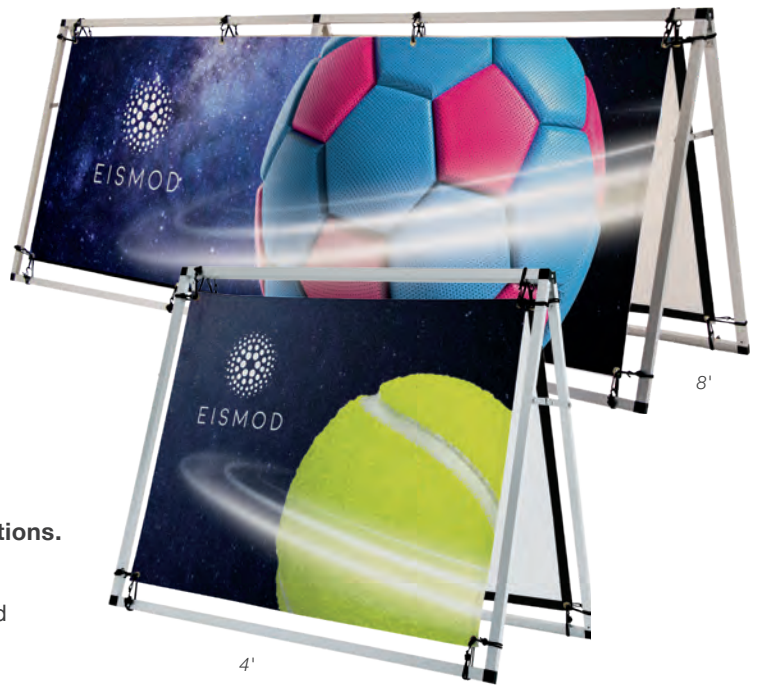

Horizontal A-Frame

Item #	Description	1	2-5	6-11	12-24
210109	4' Kit	300.00	295.00	285.00	265.00
210107	8' Kit	470.00	455.00	440.00	420.00
Kit Includes: Hardware, Stakes, Bungee Cords, 2 Single-Sided Banners (artwork can be different for each banner) and Soft Carry Case USD MSRP (C)					
Description	Product Size	Finished Graphic Size	Product Wt.	Media	
4'	51"W x 38"H x 24.75"D	46"W x 33"H	11 lbs.	Titan™ 13 oz. Scrim Vinyl	
8'	100.75"W x 38"H x 24.75"D	94"W x 33"H	18 lbs.	Titan™ 13 oz. Scrim Vinyl	



Bungee cords attach to grommets on the banner, so swapping out banners is easy.



Included stakes keep the A-frame anchored.

Suggested Uses:

- Golf Courses
- Food Trucks
- County Fairs
- Shopping Malls

SUPERSTRONG ANGLE IRON A-FRAME

Constructed of iron, this is the strongest A-frame we offer.

- Durable iron frame with a black enamel finish
- Accepts rigid substrates such as aluminum and corrugated plastic up to 0.25" thick
- Great for outdoor use
- 24" x 36" requires additional mounting hardware (not included)



Superstrong Angle Iron A-Frame

Item #	Description	1	2-5	6-11	12-24
381014	24" x 18" Kit	79.00	77.00	74.00	71.00
271078	24" x 18" Signboard Only	10.90	10.70	10.40	10.20
381012	24" x 36" Kit	110.00	108.00	104.00	102.00
271079	24" x 36" Signboard Only	21.70	21.40	21.10	20.80
Kit Includes: Frame and 2 Single-Sided Signboards (artwork can be different for each signboard) USD MSRP (C)					
24" x 36" requires additional mounting hardware (not included).					
Description	Product Size	Finished Graphic Size	Product Wt.	Media	
24" x 18"	24.5"W x 25"H x 24"D	23.5"W x 17.5"H	6.5 lbs.	4 mm Corrugated Plastic	
24" x 36"	24.25"W x 40.5"H x 25"D	23.5"W x 35.5"H	13.5 lbs.	4 mm Corrugated Plastic	



24" x 36" requires additional mounting hardware (not included).

Setup fee: \$20.00(G); no setup fee on orders placed via our website; see page 224 for details. View current graphic templates, assembly videos and instructions on our website. See pages 224-226 for additional information that may apply to your order.

AFTER FINAL PROOF APPROVAL
PRODUCTION LEAD TIME IS
2DAYS



10'

6.5'

3'



U-shaped brackets hold the top of the unit together.



Cross bars attach to the bottom of the frame for support and can be weighted down using sandbags (not included).



EUROFIT A-FRAME

This stylish A-frame features a soft graphic cover that zips over the frame. Since virtually no part of the frame is exposed, ad space is maximized.

- Sturdy, shock corded poles constructed of aluminum
- Compacts to fit into an easy-to-carry soft case
- Artwork is dye sublimated on polyester knit
- Zipper wraps around the bottom of the graphic cover so it's not visible when the A-frame is on display
- Perfect for indoor or short-term outdoor use in mild conditions
- Graphic covers used outdoors have a 90-day warranty; graphic covers used indoors have a 1-year warranty



EuroFit A-Frame

Item #	Description	1	2-5	6-11	12-24
256460	3' Kit	613.00	608.00	576.00	571.00
256463	6.5' Kit	833.00	823.00	786.00	776.00
256466	10' Kit	1065.00	1055.00	1015.00	1005.00

Kit Includes: Hardware, 2 Double-Sided Graphic Covers and Soft Carry Case USD MSRP (C)

Description	Product Size	Finished Graphic Size	Product Wt.	Media
3'	39.25"W x 37.5"H x 30.5"D	View Online Template	11 lbs.	Polyester Knit
6.5'	79"W x 37.5"H x 30.25"D	View Online Template	17 lbs.	Polyester Knit
10'	118"W x 37.5"H x 30.25"D	View Online Template	22 lbs.	Polyester Knit

TWIST-UP OVAL A-FRAME

This display twists in on itself, collapsing into a highly compacted, extremely portable unit.

- Different artwork can be used on each side
- Four ground stakes included to secure the display
- The carry case features a pouch for the ground stakes
- Graphic covers used outdoors have a 90-day warranty; graphic covers used indoors have a 1-year warranty



Twist-Up Oval A-Frame

Item #	Description	1	2-5	6-11	12-24
210318	Kit	320.00	315.00	310.00	305.00

Kit Includes: Hardware, 4 Stakes, 2 Single-Sided Graphic Covers and Soft Carry Case USD MSRP (C)

Product Size	Finished Graphic Size	Product Wt.	Media
80.25"W x 33.5"H x 23"D	View Online Template	8.25 lbs.	Polyester Knit



Twists down to a 34" diameter circle that fits neatly into the included carry case.



The display features grommets so it can be tethered to the ground using included stakes.

EUROFIT | TWIST-UP
4-5 DAYS
 AFTER FINAL PROOF APPROVAL
 PRODUCTION LEAD TIME IS

Setup fee: \$20.00(G); no setup fee on orders placed via our website; see page 224 for details.
 View current graphic templates, assembly videos and instructions on our website.
 See pages 224-226 for additional information that may apply to your order.



SUNRISE LAWN SIGN

Silhouetted like the rising sun, this lightweight variation on our popular sail signs is perfect for frequent outdoor use.

- Artwork is dye sublimated on super poly knit fabric
- Flexible fiberglass poles can be used with both banner size options
- Included ground stakes keep the display stationary in the breeze
- Lightweight and portable
- Banners have a 90-day warranty



Sunrise Lawn Sign

Item #	Description	1	2-5	6-11	12-24
263340	5"W x 4'H Single-Sided Kit	105.00	102.00	98.00	94.00
263341	5"W x 4'H Double-Sided Kit	165.00	159.00	153.00	147.00
263345	3"W x 5'H Single-Sided Kit	95.00	93.00	90.00	87.00
263346	3"W x 5'H Double-Sided Kit	145.00	140.00	134.00	129.00

Kit Includes: Hardware, Single- or Double-Sided Banner and 2 Stakes USD MSRP (C)

Description	Product Size	Finished Graphic Size	Product Wt.	Media
5"W x 4'H	59.5"W x 48"H x 1.625"D	View Online Template	2.3 lbs.	Super Poly Knit Fabric
3"W x 5'H	31.25"W x 56.625"H x 1.625"D	View Online Template	2.1 lbs.	Super Poly Knit Fabric



Black tabs on bottom of banner attach to metal pin on ground stake.

PARKING PAL

This reflective sign has a narrow footprint and can be stacked for storage, making it perfect for event parking or public garages.

- Artwork is printed on reflective media
- Two single-sided decals make a double-sided display
- Durable plastic construction prevents rust and splinters
- Maintenance-free and weather-resistant
- NCHRP compliant
- Federal Highway Administration approved
- Decals used outdoors have a 90-day warranty; decals used indoors have a 1-year warranty



Parking Pal

Item #	Description	1	2-5	6-11	12-24
264260	Parking Pal Kit	130.00	127.00	124.00	120.00

Kit Includes: Hardware and 2 Graphic Decals USD MSRP (C)

Product Size	Finished Graphic Size	Product Wt.	Media
17.625"W x 44.75"H x 14.5"D	8"W x 36"H	13 lbs.	Reflective Media



Removable rubber base for added stability.



Setup fee: \$20.00(G); no setup fee on orders placed via our website; see page 224 for details. View current graphic templates, assembly videos and instructions on our website. See pages 224-226 for additional information that may apply to your order.

PARKING PAL | SUNRISE
34 DAYS
AFTER FINAL PROOF APPROVAL
 PRODUCTION LEAD TIME IS

Suggested Uses:
Restaurants
Vendor Shows
Boutiques
Furniture Stores



Flex Sign



Flex Sign with Ballast Base



OUTDOOR FLEX SIGN

This spring-mounted sign is built to withstand the elements.

- Each poster is protected behind a sheet of clear, non-glare acrylic
- Posters are printed single-sided; two posters included in kit
- Tool-free assembly



Outdoor Flex Sign

Item #	Description	1	2-5	6-11	12-24
210127	Flex Sign Kit	360.00	355.00	345.00	330.00
263006	Flex Sign with Ballast Base Kit	395.00	390.00	380.00	370.00
Kit Includes: Hardware, 2 Protective Acrylic Sheets and 2 Single-Sided Posters (artwork can be different for each poster)		USD MSRP (C)			

Description	Product Size	Finished Graphic Size	Product Wt.	Media
Flex Sign	25.5"W x 44"H x 29"D	23.4375"W x 33.125"H	27 lbs.	Titan™ 10 oz. Scrim Vinyl
Flex Sign w/Ballast Base	31"W x 46"H x 20"D	23.4375"W x 33.125"H	26 lbs.	Titan™ 10 oz. Scrim Vinyl



Edges flip open so swapping out posters is easy.



Spring-mounted base allows sign to gently flex in the wind.



Wheels on the ballast base make it easy to move.



Ballast base can be filled with water or sand for stability.

AFTER FINAL PROOF APPROVAL
PRODUCTION LEAD TIME IS
2 DAYS

Setup fee: \$20.00(G); no setup fee on orders placed via our website; see page 224 for details.
View current graphic templates, assembly videos and instructions on our website.
See pages 224-226 for additional information that may apply to your order.

CORRUGATED PLASTIC SIGN

Great for use on lawns, this sign gives you a simple, inexpensive way to get your message noticed.

- Constructed of 4 mm corrugated plastic
- Full-color artwork can be printed on one or both sides
- Custom sizes available (call for quote; restrictions may apply)



Corrugated Plastic Sign

Item #	Description	1	2-5	6-11	12-24
271109	36"W x 24"H - Unimprinted	6.60	6.50	6.30	6.10
271110	36"W x 24"H - Single-Sided	21.70	21.30	20.60	20.00
271111	36"W x 24"H - Double-Sided	28.50	27.50	26.00	25.00
271112	24"W x 18"H - Unimprinted	3.90	3.80	3.70	3.60
271113	24"W x 18"H - Single-Sided	14.40	14.10	13.70	13.20
271114	24"W x 18"H - Double-Sided	18.80	18.40	17.90	17.30

USD MSRP (C)



STEP STAKES

- Installation is quick and easy
- Choose from two designs

Step Stakes

Item #	Description	1-10	11-20	21-30	31+
381501	Standard Step Stake	2.22	2.16	2.11	2.08
381506	U-Top Step Stake	4.30	4.20	4.10	4.00

USD MSRP (C)

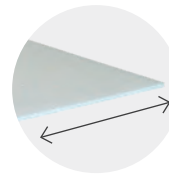

Stakes slide into fluted openings along the width of the signboard.

Standard Step Stake (sold separately)

OUTDOOR RIGID BASE SIGN

A simple, durable plastic base provides an easy outdoor sign solution.

- Base can be filled with water or sand for stability
- Signboard is printed double-sided



Outdoor Rigid Base Sign

Item #	Description	1	2-5	6-11	12-24
210371	4 mm Rectangle Kit	111.00	107.00	103.00	99.00
210372	10 mm Rectangle Kit	116.00	113.00	109.00	102.00
210560	4 mm Can Kit	111.00	107.00	103.00	99.00
210561	10 mm Can Kit	116.00	113.00	109.00	102.00
210564	4 mm Arrow Kit	124.00	118.00	111.00	104.00
210565	10 mm Arrow Kit	130.00	124.00	117.00	110.00

Kit Includes: Hardware and Double-Sided Signboard USD MSRP (C)

Description	Product Size	Finished Graphic Size	Product Wt. (4 mm / 10 mm)	Media
Rectangle	24"W x 40.5"H x 17.25"D	24"W x 36"H	5.25 lbs. / 6.5 lbs.	Corrugated Plastic
Can	24"W x 40.5"H x 17.25"D	24"W x 36"H	5.25 lbs. / 6.5 lbs.	Corrugated Plastic
Arrow	40"W x 36.5"H x 17.25"D	40"W x 32"H	5.25 lbs. / 6.25 lbs.	Corrugated Plastic



Drill two small holes in the signboard and secure into place using the two fasteners on the base.



Rectangle

Can

Arrow

Setup fee: \$20.00(G); no setup fee on orders placed via our website; see page 224 for details. View current graphic templates, assembly videos and instructions on our website. See pages 224-226 for additional information that may apply to your order.

AFTER FINAL PROOF APPROVAL
PRODUCTION LEAD TIME IS
2 DAYS



EUROFIT BARRIER

This barrier helps you corral the crowd, and its large printable surface provides low-cost advertising space.

- Ideal for indoor or short-term outdoor use
- Steel feet keep the unit stable
- Artwork is dye sublimated on polyester knit
- Graphic cover slips over the frame like a pillowcase
- Fabric contours to the frame for a form-fitted look
- Lightweight aluminum frame
- Joints are labeled for step-by-step frame assembly
- Push-button connectors make it easy to assemble
- Graphic covers used outdoors have a 90-day warranty; graphic covers used indoors have a 1-year warranty



EuroFit Barrier

Item #	Description	1	2-5	6-11	12-24
256530	4' Kit	366.00	351.00	337.00	322.00
256533	7' Kit	464.00	450.00	433.00	417.00

Kit Includes: Hardware, Graphic Cover and Soft Carry Case with Wheels USD MSRP (C)

EuroFit Barrier Connector Kit

Item #	Description	1	2-5	6-11	12-24
256536	Kit	67.00	64.00	62.00	59.00

Kit Includes: Connector Foot and 2 EuroFit Connectors USD MSRP (C)

Description	Product Size	Finished Graphic Size	Product Wt.	Media
4'	62.875"W x 39.75"H x 16"D	View Online Template	27 lbs.	Polyester Knit
7'	98.5"W x 39.75"H x 16"D	View Online Template	28.4 lbs.	Polyester Knit
Connector Foot	10"W x 16"D	N/A	8.6 lbs.	N/A



Connector Kit

Hinge together multiple EuroFit barriers with the connector kit. Includes one connector foot and two EuroFit Connectors (US Patent #9637963).



Suggested Uses:

Parades
Restaurants
Festivals
Sporting Events



BARRICADE COVER

Transform your event barricade into a prime advertising opportunity.

- Covers the full barricade (barricade not included)
- Maximize your impact by featuring a different design on each side
- Available in two-way stretch fabric or Titan™ 18 oz. opaque scrim vinyl
- Custom sizes and other media options available (call for quote; restrictions may apply)
- Barricade Covers used outdoors have a 90-day warranty; Barricade Covers used indoors have a 1-year warranty



Barricade Cover

Item #	Description	Product Wt.	1	2-5	6-11	12-24
302090	3' x 7' Two-Way Stretch Fabric Cover	1.8 lbs.	250.00	238.00	225.00	213.00
302091	3' x 7' 18 oz. Opaque Scrim Vinyl Cover	3.8 lbs.	239.00	227.00	215.00	203.00
302092	3' x 8' Two-Way Stretch Fabric Cover	2.2 lbs.	260.00	247.00	234.00	221.00
302093	3' x 8' 18 oz. Opaque Scrim Vinyl Cover	4.4 lbs.	250.00	238.00	225.00	213.00
302094	3' x 10' Two-Way Stretch Fabric Cover	2.8 lbs.	272.00	258.00	245.00	231.00
302095	3' x 10' 18 oz. Opaque Scrim Vinyl Cover	5.4 lbs.	260.00	247.00	234.00	221.00

USD MSRP (C)



Covers are curved and open along the corners.



Hook-and-loop fasteners secure the cover.

BARRICADE COVER OR EUROFIT BARRIER
AFTER FINAL PROOF APPROVAL
PRODUCTION LEAD TIME IS
3 OR 4 DAYS

Setup fee: \$20.00(G); no setup fee on orders placed via our website; see page 224 for details.
View current graphic templates, assembly videos and instructions on our website.
See pages 224-226 for additional information that may apply to your order.



FRAMEWORX FLEX

This addition to our popular FrameWorx display features a fabric mesh banner that can be used outdoors.

- Designed for short-term outdoor use; will withstand light wind conditions (10-15 mph)
- Banner features clear plastic grommets
- Wheels on the base make it easy to move
- Tool-free assembly
- Banners used outdoors have a 90-day warranty; banners used indoors have a 1-year warranty



FrameWorx Flex

Item #	Description	1	2-5	6-11	12-24
210342	Single-Banner Kit	501.00	476.00	451.00	425.00
210343	Double-Banner Kit	624.00	606.00	560.00	541.00
Kit Includes: Hardware, Single-Sided Banner(s) and Soft Carry Case		USD MSRP (C)			
Product Size		Finished Graphic Size		Product Wt. (Single / Double)	
41.25"W x 98.875"H x 21.5"D		View Online Template		27 lbs. / 27.5 lbs.	
				Media	
				Fabric Mesh	



Tension corner springs keep the banner centered and taut.



Artwork is dye sublimated on fabric mesh.

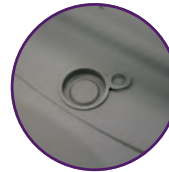

Plastic ballast base can be filled with sand or water.



EUROFIT BALLAST BASE

This beautiful fabric display is perfect for short-term use in mild outdoor conditions.

- Artwork is dye sublimated on polyester knit
- Graphic cover slips over the frame like a pillowcase
- Fabric contours to the frame for a form-fitted look
- Lightweight aluminum frame
- Joints are labeled for step-by-step frame assembly
- Recommended for use in wind speeds under 15 mph; product should be moved indoors if bad weather is likely
- Graphic covers used outdoors have a 90-day warranty; graphic covers used indoors have a 1-year warranty



EuroFit Ballast Base

Item #	Description	1	2-5	6-11	12-24
256470	Kit	257.00	248.00	239.00	229.00
Kit Includes: Hardware and Graphic Cover		USD MSRP (C)			
Product Size		Finished Graphic Size		Product Wt.	
23.5"W x 55"H x 17.125"D		View Online Template		8 lbs.	
				Media	
				Polyester Knit	



Plastic ballast base can be filled with sand or water.



Aluminum frame attaches to the ballast base using a thumbscrew.



Push-button connectors make it easy to assemble.



Setup fee: \$20.00(G); no setup fee on orders placed via our website; see page 224 for details. View current graphic templates, assembly videos and instructions on our website. See pages 224-226 for additional information that may apply to your order.

AFTER FINAL PROOF APPROVAL
PRODUCTION LEAD TIME IS
4 DAYS

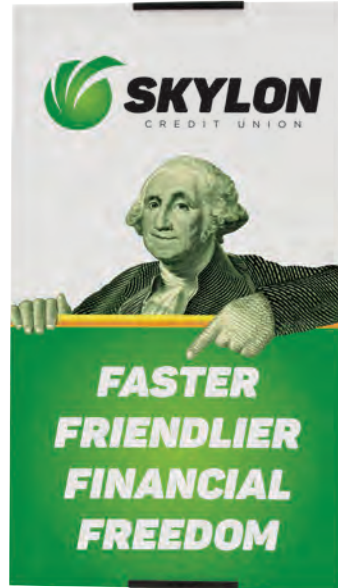
24" x 32"
double-signboard24" x 42"
single-signboard

BASE-X SIGN

This signpost's space-saving base folds out to an X shape for a sleek look that draws attention to the signboard.

- Pole is constructed of aluminum and features a hard plastic base
- Hardware is adjustable to accommodate a variety of signboard sizes
- Signboard is printed single-sided; double-sided kits include two signboards
- Signboards have a six-month warranty



Base-X Sign

Item #	Description	1	2-5	6-11	12-24
263133	24" x 32" Single-Signboard Kit	175.00	168.00	161.00	154.00
263134	24" x 32" Double-Signboard Kit	222.00	217.00	204.00	199.00
263138	24" x 32" Signboard Only (1)	51.00	49.00	47.00	45.00
263135	24" x 42" Single-Signboard Kit	186.00	179.00	171.00	164.00
263136	24" x 42" Double-Signboard Kit	244.00	239.00	224.00	219.00
263139	24" x 42" Signboard Only (1)	62.00	60.00	57.00	55.00

Kit Includes: Hardware, Single-Sided Signboard(s) and Soft Carry Case USD MSRP (C)

Description	Product Size	Finished Graphic Size	Product Wt. (Single / Double)	Media
24" x 32"	23.75"W x 65.25"H x 13.5"D	23.75"W x 32"H	7.25 lbs. / 8 lbs.	Foamcore
24" x 42"	23.75"W x 65.25"H x 13.5"D	23.75"W x 42"H	7.5 lbs. / 8.25 lbs.	Foamcore



Fold-out feet create a small, X-shaped footprint.



Adjustable brackets on the frame secure the signboard.

Single Sign with
chrome hardwareFlat Base Sign with
black hardwarePedestal Snap
Frame Sign

Pedestal Sign

SIGN DISPLAYS

These sign displays come in a variety of designs to show off your message with style.

- Single and Flat Base Sign hardware available in black or chrome
- Pedestal Snap Frame and Pedestal Sign hardware available in chrome only



Sign Displays

Item #	Description	1	2-5	6-11	12-24
400057	Single Sign Kit	163.00	158.00	154.00	149.00
400055	Flat Base Sign Kit	157.00	152.00	147.00	138.00
400023	Pedestal Snap Frame Sign Kit	147.00	141.00	136.00	130.00
400025	Pedestal Sign Kit	163.00	159.00	154.00	150.00

Sign Kits Include: Hardware and Double-Sided Signboard
Snap Frame Kit Includes: Hardware and Single-Sided Poster USD MSRP (C)

Description	Product Size	Finished Graphic Size	Product Wt.	Media
Single	23.25"W x 55.75"H x 15"D	22"W x 28"H	13 lbs.	4 mm Corrugated Plastic
Flat Base	22.25"W x 59.75"H x 10"D	22"W x 28"H	13.5 lbs.	4 mm Corrugated Plastic
Pedestal Snap Frame	13.125"W x 32.25"-48.625"H x 9.875"D	10.5"W x 8"H	5.5 lbs.	Titan™ Polypropylene Media
Pedestal	22.25"W x 65"H x 18.5"D	21"W x 26.75"H	14.5 lbs.	4 mm Corrugated Plastic

SNAP FRAME
2 or **3** DAYS
AFTER FINAL PROOF APPROVAL
PRODUCTION LEAD TIME IS

Setup fee: \$20.00(G); no setup fee on orders placed via our website; see page 224 for details.
View current graphic templates, assembly videos and instructions on our website.
See pages 224-226 for additional information that may apply to your order.

Suggested Uses:

- Lobbies
- Schools
- Banks
- Libraries

IMPRESS SIGN

This versatile sign utilizes two silicone edge graphics (SEG) for an upscale look and lets you add accessories for a customizable display.

- Graphic panels are printed single-sided; kit comes with two panels for a double-sided display
- Artwork is dye sublimated on polyester knit
- Shelf and literature rack (sold separately) can be added to the frame for easy access to catalogs and brochures
- Assembly tools included

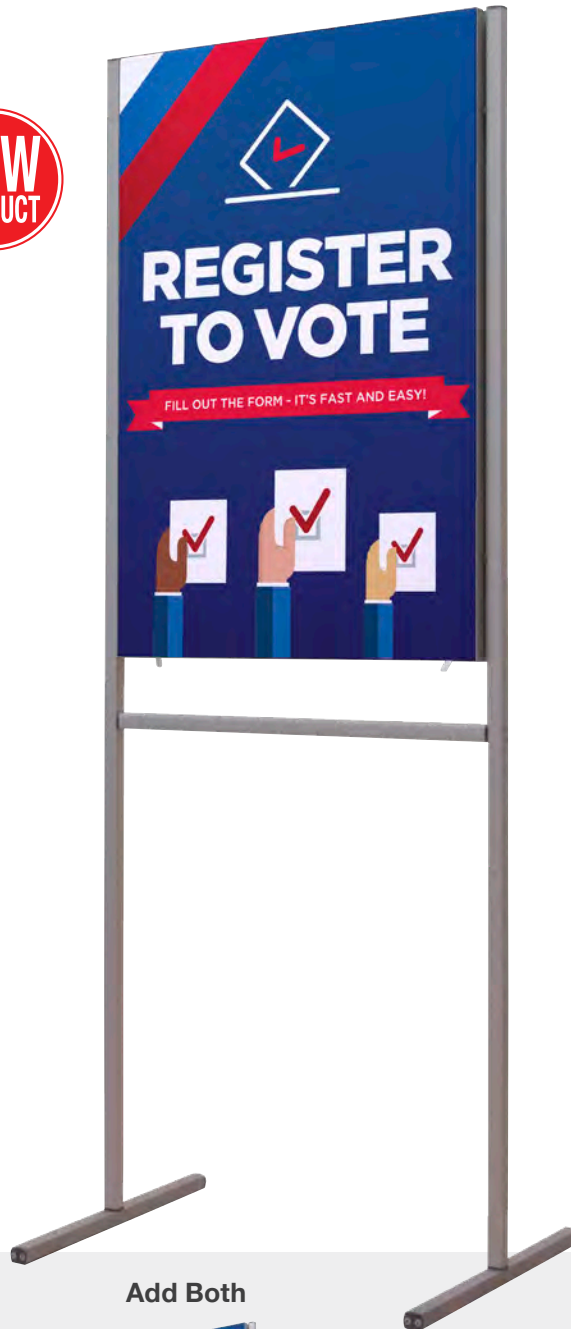

SIGNAGE

Impress Sign

Item #	Description	1	2-5	6-11	12-24
264250	Kit	350.00	336.00	322.00	308.00
264254	Brochure Rack Add-On	55.00	53.90	52.30	50.60
264255	Steel Shelf Add-On	45.00	44.10	42.80	41.40
264256	Wheels Add-On (Set of 4)	35.00	34.30	33.30	32.20

Kit Includes: Hardware and 2 Single-Sided Graphic Panels USD MSRP (C)

Product Size 26.125"W x 70.5"H x 20"D
Finished Graphic Size View Online Template
Product Wt. 14.25 lbs.
Media Polyester Knit



With a quick press of your thumb, the fabric's gasket edge is pushed into narrow channels built into the frame.



Discreet pull tab for easy graphic removal.

Add a Shelf



Impress Sign with Shelf

Add a Brochure Rack



Impress Sign with Brochure Rack

Add Both



Impress Sign with Shelf and Brochure Rack



Make the sign portable by adding wheels (sold separately), two locking and two non-locking, to the frame base.

Setup fee: \$20.00(G); no setup fee on orders placed via our website; see page 224 for details. View current graphic templates, assembly videos and instructions on our website. See pages 224-226 for additional information that may apply to your order.

AFTER FINAL PROOF APPROVAL PRODUCTION LEAD TIME IS
4 DAYS



24" x 36"

17" x 22" shown horizontally

FRONT-LOAD SNAP FRAME

Change out posters without having to remove the frame from the wall.

- Lightweight aluminum frame can be hung vertically or horizontally
- Artwork is printed on Titan™ polypropylene media
- Acrylic insert protects the poster
- Mounting hardware included



Front-Load Snap Frame

Item #	Description	1	2-5	6-11	12-24
292040	11" x 17" Kit	105.00	99.00	94.00	88.00
191110	11" x 17" Poster Only	30.50	29.50	28.50	28.00
292042	17" x 22" Kit	121.00	119.00	113.00	110.00
191111	17" x 22" Poster Only	31.00	30.00	29.00	28.00
292044	22" x 28" Kit	169.00	163.00	158.00	152.00
191112	22" x 28" Poster Only	55.50	54.00	52.00	50.50
292046	24" x 36" Kit	184.00	178.00	173.00	167.00
191113	24" x 36" Poster Only	60.50	58.50	57.00	55.00

Kit Includes: Hardware, Poster, Protective Acrylic Insert and Mounting Hardware USD MSRP (C)

Description	Product Size	Finished Graphic Size	Product Wt.	Media
11" x 17"	12.25"W x 18.25"H x 0.5"D	11"W x 17"H	1.75 lbs.	Titan™ Polypropylene Media
17" x 22"	18.25"W x 23.25"H x 0.5"D	17"W x 22"H	2.5 lbs.	Titan™ Polypropylene Media
22" x 28"	23.25"W x 29.25"H x 0.5"D	22"W x 28"H	3.25 lbs.	Titan™ Polypropylene Media
24" x 36"	25.25"W x 37.25"H x 0.5"D	24"W x 36"H	4.5 lbs.	Titan™ Polypropylene Media

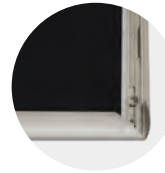

Edges flip open so swapping out posters is easy.



Frames available in silver or black.



TOP-LOAD FRAME

This vertical frame features a concealed top-loading slot that makes graphic changes simple.

- Lightweight aluminum frame
- Artwork is printed on Titan™ polypropylene media
- Acrylic insert protects the poster
- Mounting hardware included



Top-Load Frame

Item #	Description	1	2-5	6-11	12-24
293020	8.5" x 11" Kit	77.00	72.00	66.00	63.00
190194	8.5" x 11" Poster Only	26.00	25.00	24.50	23.50
293022	17" x 22" Kit (Black Frame Only)	95.00	89.00	84.00	82.00
190196	17" x 22" Poster Only	31.00	30.00	29.00	28.00
293024	22" x 28" Kit	128.00	122.00	117.00	111.00
190197	22" x 28" Poster Only	56.00	55.00	54.00	53.00
293026	24" x 36" Kit (Black Frame Only)	163.00	157.00	152.00	146.00
191129	24" x 36" Poster Only	60.50	58.50	57.00	55.00

Kit Includes: Hardware, Poster, Protective Acrylic Insert and Mounting Hardware USD MSRP (C)

Description	Product Size	Finished Graphic Size	Product Wt.	Media
8.5" x 11"	9.75"W x 12.25"H x 1"D	8.5"W x 11"H	1.5 lbs.	Titan™ Polypropylene Media
17" x 22"	18.25"W x 23.25"H x 1"D	17"W x 22"H	2 lbs.	Titan™ Polypropylene Media
22" x 28"	23.25"W x 29.25"H x 1"D	22"W x 28"H	2.75 lbs.	Titan™ Polypropylene Media
24" x 36"	25.5"W x 37.25"H x 1"D	24"W x 36"H	3.5 lbs.	Titan™ Polypropylene Media



Simply slide the poster into the top of the frame.



8.5" x 11" and 22" x 28" frames available in silver or black.

AFTER FINAL PROOF APPROVAL
PRODUCTION LEAD TIME IS
2 DAYS

Setup fee: \$20.00(G); no setup fee on orders placed via our website; see page 224 for details.
View current graphic templates, assembly videos and instructions on our website.
See pages 224-226 for additional information that may apply to your order.

Suggested Uses:

- Restaurants
- Bars
- Wedding Expos
- Liquor Stores

CRYSTAL EDGE DISPLAY

The glow of this illuminated sign will draw every eye in the room.

- Optical acrylic frame
- LED power lasts more than 50,000 hours
- Artwork is printed on Titan™ backlit film
- Can be displayed horizontally or vertically
- Mounting hardware included



Crystal Edge Display

Item #	Description	1	2-5	6-11	12-24
325050	14" x 20" Kit	250.00	245.00	240.00	235.00
325052	25" x 31" Kit	375.00	370.00	365.00	360.00
325054	Connector Hardware	111.00	109.00	105.00	102.00

Kit Includes: Frame, Backlit Poster, AC Adapter and Mounting Hardware USD MSRP (C)

Description	Product Size	Finished Graphic Size	Product Wt.	Media
14" x 20"	19.75"W x 13.75"H x 1.25"D	16"W x 10"H	5 lbs.	Backlit Media
25" x 31"	30.75"W x 24.75"H x 1.75"D	27"W x 21"H	13.7 lbs.	Backlit Media



Loosen bolts when you need to swap out posters.

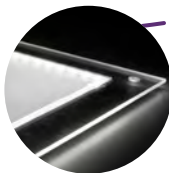

Powerful LED lights along the inside edges of the frame diffuse the light evenly for a gentle glow.

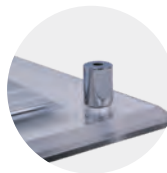

Standoffs create space between wall and display to emphasize illumination.



Connectors (sold separately) let you create a dual-sided light box by joining two displays together.

LIGHTS UP!

SIGNAGE

LED LIGHT BOX

LED light boxes offer a brighter and more energy-efficient alternative to traditional light box designs.

- Lightweight aluminum frame can be hung vertically or horizontally
- LED power lasts more than 50,000 hours
- Artwork is printed on Titan™ backlit film
- Mounting hardware included



LED Light Box

Item #	Description	1	2-5	6-11	12-24
325031	23.5" x 17.5" Kit	305.00	300.00	295.00	290.00
325032	27.5" x 21.5" Kit	415.00	400.00	380.00	365.00
325033	35.5" x 23.5" Kit	590.00	575.00	560.00	540.00

Kits Include: Frame, Backlit Poster, AC Adapter and Mounting Hardware USD MSRP (C)

Description	Product Size	Finished Graphic Size	Product Wt.	Media
23.5" x 17.5"	25.6"W x 19.6"H x .875"D	23.5"W x 17.5"H	8.5 lbs.	Backlit Media
27.5" x 21.5"	29.6"W x 23.6"H x .875"D	27.5"W x 21.5"H	10.5 lbs.	Backlit Media
35.5" x 23.5"	37.6"W x 25.6"H x .875"D	35.5"W x 23.5"H	14 lbs.	Backlit Media



Edges flip open so swapping out posters is easy.



Powerful LED lights along the inside the frame create a soothing glow.

LIGHTS UP!



Setup fee: \$20.00(G); no setup fee on orders placed via our website; see page 224 for details. View current graphic templates, assembly videos and instructions on our website. See pages 224-226 for additional information that may apply to your order.

AFTER FINAL PROOF APPROVAL
PRODUCTION LEAD TIME IS
2DAYS



18" x 24"



CANVAS SIGNBOARD

Turn your favorite photos and memories into beautiful decoration pieces with our hanging canvas signboards.

- Print is gallery-wrapped around frame to maximize graphic space
- Artwork is printed with UV protected ink on durable Canvas fabric
- Wood frames are sourced from domestically sustainable pine forests
- Custom sizes available (call for quote; restrictions may apply)



Canvas is hand-stretched over a wood frame.

Canvas Signboard

Item #	Description	1	2-5	6-11	12-24
325150	11" x 14"	82.00	78.00	74.00	70.00
325153	12" x 36"	103.00	98.00	93.00	88.00
325156	16" x 20"	103.00	98.00	93.00	88.00
325159	18" x 24"	113.00	107.00	102.00	96.00
325162	24" x 36"	155.00	147.00	140.00	132.00
325165	30" x 40"	185.00	176.00	167.00	157.00
325168	24" x 60"	216.00	205.00	194.00	184.00
325171	36" x 36"	185.00	176.00	167.00	157.00
325174	36" x 48"	216.00	205.00	194.00	184.00
325177	36" x 60"	247.00	235.00	222.00	210.00

USD MSRP (C)

Description	Product Size	Finished Graphic Size	Product Wt.	Media
11" x 14"	14"W x 11"H x 1.5"D	11" x 14"	1.5 lbs.	Canvas Fabric
12" x 36"	36"W x 12"H x 1.5"D	12" x 36"	3 lbs.	Canvas Fabric
16" x 20"	20"W x 16"H x 1.5"D	16" x 20"	2.5 lbs.	Canvas Fabric
18" x 24"	24"W x 18"H x 1.5"D	18" x 24"	2.5 lbs.	Canvas Fabric
24" x 36"	36"W x 24"H x 1.5"D	24" x 36"	5 lbs.	Canvas Fabric
30" x 40"	40"W x 30"H x 1.5"D	30" x 40"	7 lbs.	Canvas Fabric
24" x 60"	60"W x 24"H x 1.5"D	24" x 60"	6 lbs.	Canvas Fabric
36" x 36"	36"W x 36"H x 1.5"D	36" x 36"	7 lbs.	Canvas Fabric
36" x 48"	48"W x 36"H x 1.5"D	36" x 48"	7.5 lbs.	Canvas Fabric
36" x 60"	60"W x 36"H x 1.5"D	36" x 60"	8 lbs.	Canvas Fabric

AFTER FINAL PROOF APPROVAL
PRODUCTION LEAD TIME IS
4 DAYS

Setup fee: \$20.00(G); no setup fee on orders placed via our website; see page 224 for details.
View current graphic templates, assembly videos and instructions on our website.
See pages 224-226 for additional information that may apply to your order.

Suggested Uses:
 Offices
 Museums
 Retail Stores
 Recreation Rooms



20" x 24"



16" x 20"

GLOSSY ALUMINUM SIGNBOARD

Add some flair to your art by showing it off on a sleek and modern-looking aluminum sign.

- Perfect for use as plaques, signage, or home décor
- Scratch-resistant for long-term use
- Aluminum with white basecoat make colors pop
- Available with installed shadow mount or as signboard only
- Signboard is printed single-sided
- No assembly required



Glossy Aluminum Signboard

Item #	Description	Product Wt.	1	2-5	6-11	12-24
264200	8" x 8" Signboard	0.2 lb.	17.00	16.70	16.20	15.60
264201	8" x 8" Signboard with Shadow Mount	0.4 lb.	22.00	21.60	20.90	20.20
264202	8" x 10" Signboard	0.25 lb.	20.00	19.60	19.00	18.40
264203	8" x 10" Signboard with Shadow Mount	0.5 lb.	25.00	24.50	23.80	23.00
264204	12" x 12" Signboard	0.4 lb.	29.00	28.40	27.60	26.70
264205	12" x 12" Signboard with Shadow Mount	0.6 lb.	34.00	33.30	32.30	31.30
264206	11" x 14" Signboard	0.45 lb.	42.00	41.20	39.90	38.60
264207	11" x 14" Signboard with Shadow Mount	0.65 lb.	47.00	46.10	44.70	43.20
264208	12" x 18" Signboard	0.6 lb.	49.00	48.00	46.60	45.10
264209	12" x 18" Signboard with Shadow Mount	0.8 lb.	56.50	55.40	53.70	52.00
264210	16" x 16" Signboard	0.7 lb.	41.00	40.20	39.00	37.70
264211	16" x 16" Signboard with Shadow Mount	0.9 lb.	48.50	47.50	46.10	44.60
264212	16" x 20" Signboard	0.8 lb.	65.00	63.70	61.80	59.80
264213	16" x 20" Signboard with Shadow Mount	2.2 lbs.	72.50	71.10	68.90	66.70
264214	20" x 24" Signboard	1.2 lbs.	94.00	92.10	89.30	86.50
264215	20" x 24" Signboard with Shadow Mount	2.6 lbs.	101.50	99.50	96.40	93.40
264216	20" x 30" Signboard	1.8 lbs.	120.00	117.60	114.00	110.40
264217	20" x 30" Signboard with Shadow Mount	3.2 lbs.	127.50	125.00	121.10	117.30
264218	24" x 36" Signboard	2.6 lbs.	210.00	202.00	193.00	185.00
264219	24" x 36" Signboard with Shadow Mount	4 lbs.	218.00	209.00	201.00	192.00

USD MSRP (C)



Hidden Shadow Mount hardware lets you hang your art on the wall like a picture frame.

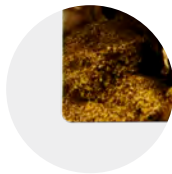

Finished with rounded corners.

Add-On



This stand features a satin finish and turns your sign into a freestanding display.



16" x 16" signboard with 12" stand

Glossy Aluminum Signboard Stand

Item #	Description	Product Wt.	1	2-5	6-11	12-24
264092	8" Stand	0.2 lb.	12.50	12.30	11.90	11.50
264093	12" Stand	0.4 lb.	18.00	17.60	17.10	16.60

8" Stand holds up to a 12" x 12" aluminum signboard.
 12" Stand holds up to a 16" x 16" aluminum signboard.
 USD MSRP (C)

Setup fee: \$20.00(G); no setup fee on orders placed via our website; see page 224 for details.
 View current graphic templates, assembly videos and instructions on our website.
 See pages 224-226 for additional information that may apply to your order.

AFTER FINAL PROOF APPROVAL
 PRODUCTION LEAD TIME IS
2DAYS



Suggested Uses:
Gas Stations
Retail Shops
Auto Shops
Travel Agencies

COUNTERTOP MAT

Dress up your desk or countertop with these custom-printed mats.

- Artwork is printed on one side of the mat
- Scratch-resistant print
- No-slip PVC foam backing keeps the mat in place
- Not recommended for use with food



Countertop Mat

Item #	Description	Product Wt.	1	2-5	6-11	12-24
259080	10" x 15" Mat (set of 6)	1.3 lbs.	86.00	83.00	79.00	76.00
259081	11" x 17" Mat (set of 6)	1.5 lbs.	98.00	94.00	90.00	86.00
259082	16" x 20" Mat (set of 6)	1.7 lbs.	136.00	131.00	125.00	120.00
259083	17" x 26" Mat (set of 6)	1.8 lbs.	152.00	146.00	140.00	134.00

USD MSRP (C)



2.4 mm PVC-coated fabric is backed with PVC foam.



Mats are finished with rounded corners.



Stain-resistant and easy to clean.



Sold in sets of six.



DOOR WRAP

Add full-color artwork or ad space to a door using this attractive fabric wrap.

- Artwork is dye sublimated on two-way stretch fabric
- No adhesive tape needed
- Fits standard doors 80" tall
- Custom sizes available (call for quote; restrictions may apply)
- Wraps used outdoors have a 90-day warranty; wraps used indoors have a 1-year warranty



Door Wrap

Item #	Description	1	2-5	6-11	12-24
263164	24" Door Wrap	129.00	124.00	119.00	114.00
263165	31" Door Wrap	149.00	143.00	137.00	131.00

USD MSRP (C)

Description	Product Size	Finished Graphic Size	Product Wt.	Media
24"	24"W x 80"H	View Online Template	1.25 lbs.	Two-Way Stretch Fabric
31"	31"W x 80"H	View Online Template	1.5 lbs.	Two-Way Stretch Fabric



Easy setup; simply slide the wrap over a door.

MATS DOOR WRAP
AFTER FINAL PROOF APPROVAL
PRODUCTION LEAD TIME IS
3 OR 4 DAYS

Setup fee: \$20.00(G); no setup fee on orders placed via our website; see page 224 for details.
View current graphic templates, assembly videos and instructions on our website.
See pages 224-226 for additional information that may apply to your order.

INDOOR SURFACE GRIP

This temporary floor or wall decal works on a variety of surface types, even carpet.

- Textured matte vinyl with fabric backing and solvent acrylic adhesive
- Rounded corners for a finished look
- Easy to apply and remove
- Footprints come in sets of ten; different artwork can be applied to each footprint
- One-year warranty when used on walls; 30-day warranty when used on floors
- Certified slip resistant (ASTM D-2047 & R12)
- Custom sizes and shapes available (call for quote; restrictions may apply)



Indoor Surface Grip

Item #	Description	Product Wt.	1	2-5	6-11	12-24
259060	2' x 4'	0.6 lb.	65.10	63.80	61.80	59.90
259065	3' x 5'	1.2 lbs.	129.00	124.00	119.00	114.00
259066	3' x 8'	2 lbs.	193.00	185.00	178.00	170.00
259061	4' x 4'	1.2 lbs.	131.00	126.00	121.00	115.00
259067	4' x 6'	1.4 lbs.	176.00	169.00	162.00	155.00
259062	4' x 8'	2.4 lbs.	255.00	245.00	235.00	224.00
259063	42" Circle	0.6 lb.	131.00	126.00	121.00	115.00
259064	72" x 42" Arrow	0.8 lb.	310.00	305.00	300.00	290.00
259088	Footprints (Set of 10)	0.2 lb.	34.80	34.10	33.10	32.00

USD MSRP (C)



SIGNAGE



Footprints (available in Surface Grip only)



Circle



4' x 8'



Arrow

OUTDOOR SURFACE TAC

Designed for walkable and drivable surfaces, Surface Tac is perfect for outdoor use.

- Recyclable, aluminum foil-based commercial media
- Rounded corners for a finished look
- Certified slip resistant (ASTM D-2047 & NSF1)
- Custom sizes and shapes available (call for quote; restrictions may apply)



Outdoor Surface Tac

Item #	Description	Product Wt.	1	2-5	6-11	12-24
259070	2' x 4'	0.8 lb.	109.00	105.00	100.00	96.00
259071	4' x 4'	1.8 lbs.	195.00	187.00	179.00	172.00
259072	4' x 8'	3.8 lbs.	390.00	380.00	375.00	365.00
259073	42" Circle	1 lb.	195.00	187.00	179.00	172.00
259074	72" x 42" Arrow	1.2 lbs.	320.00	315.00	305.00	300.00

USD MSRP (C)



Setup fee: \$20.00(G); no setup fee on orders placed via our website; see page 224 for details. View current graphic templates, assembly videos and instructions on our website. See pages 224-226 for additional information that may apply to your order.

AFTER FINAL PROOF APPROVAL
PRODUCTION LEAD TIME IS
3DAYS

Suggested Uses:
Retail Stores
Restaurants
Hotels
Banks

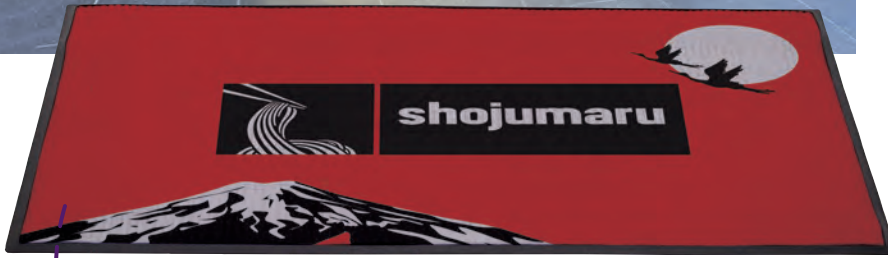

Constructed of 65 mil nitrile rubber with needle-punched polyester carpet.

STORM MAT

This water-absorbent mat makes a great first impression when placed in entryways.

- Absorbs up to 1.5 gallons of water per square yard
- Easy to clean using a vacuum, steam cleaner or hose
- UV-resistant and treated with Stainstopper™
- Mat sizes are not exact; allow 3-5% size variance
- Not eligible for Rush Service



Storm Mat

Item #	Description	Product Wt.	1	2-5	6-10	11-25
259030	2' x 3' Mat	4 lbs.	320.00	237.00	203.00	196.00
259031	3' x 5' Mat	10 lbs.	364.00	269.00	231.00	223.00
259032	4' x 6' Mat	14 lbs.	462.00	342.00	293.00	283.00

USD MSRP (C)

Item has limited number of available colors (56). We cannot guarantee color matching. Test strip/match print/test grid not available.



Mat features chemical-resistant plush carpet.

FLOOR HUGGER MAT

Put quality designs right at your feet. The Floor Hugger mat features a nylon yarn surface with black rubber borders and backing.

- Treated with Stainstopper™ and static dissipative
- Will not crack or curl
- Mat sizes are not exact; allow 3-5% size variance
- Not eligible for Rush Service



Floor Hugger Mat

Item #	Description	Product Wt.	1	2-5	6-10	11-25
259000	3' x 5' Mat	8 lbs.	272.00	201.00	172.00	167.00
259001	3' x 10' Mat	16 lbs.	447.00	389.00	335.00	324.00
259002	4' x 6' Mat	12 lbs.	348.00	305.00	261.00	252.00

USD MSRP (C)

Item has limited number of available colors (150). We cannot guarantee color matching. Test strip/match print/test grid not available.



AFTER FINAL PROOF APPROVAL
PRODUCTION LEAD TIME IS
7 DAYS

Setup fee: \$20.00(G); no setup fee on orders placed via our website; see page 224 for details.
View current graphic templates, assembly videos and instructions on our website.
See pages 224-226 for additional information that may apply to your order.

Suggested Uses:
Car Dealerships
Lobbies
Showrooms
Special Events



MARKETING MAT

This scratch-resistant floor mat makes your graphic stand up to even the most high-traffic areas.

- Artwork is printed on the underside of a clear mat to ensure graphic does not scratch
- Wipes clean with a damp cloth
- Certified Slip resistant (ASTM D 2047)
- Best for indoor use
- Custom sizes available (call for quote; restrictions may apply)



SIGNAGE



Marketing Mat

Item #	Description	Product Wt.	1	2-5	6-11	12-24
259100	2' x 4'	0.15 lb.	160.00	157.00	154.00	149.00
259101	3' x 5'	0.3 lb.	240.00	235.00	230.00	225.00
259102	4' x 4'	0.3 lb.	315.00	310.00	300.00	295.00
259103	4' x 6'	0.45 lb.	455.00	445.00	435.00	425.00
259104	4' x 8'	0.6 lb.	600.00	590.00	575.00	560.00

USD MSRP (C)



Vinyl is finished with non-slip backing for stability.



Finished with rounded corners.

FLOOR DECOR

High-quality, foam-backed flooring is extremely durable, and it's perfect for grabbing attention in lobbies or at events.

- Artwork is printed on one side of the Floor Decor
- Lays flat for a clean, smooth look
- Wipes clean with a damp cloth
- Custom sizes and shapes available (call for quote; restrictions may apply)
- Best for indoor use
- 10' x 10' and 9' round Floor Decor must ship by truck



Floor Decor

Item #	Description	Weight	1	2-5	6-11	12-24
259058	3' x 3' Floor Decor	1.6 lbs.	217.00	208.00	200.00	191.00
259059	3' Round Floor Decor	1.2 lbs.	217.00	208.00	200.00	191.00
259050	8' x 8' Floor Decor	14 lbs.	870.00	855.00	835.00	810.00
259051	8' x 10' Floor Decor	17 lbs.	870.00	855.00	835.00	810.00
259053	9' Round Floor Decor	14 lbs.	1035.00	1015.00	995.00	965.00
259052	10' x 10' Floor Decor	22 lbs.	1035.00	1015.00	995.00	965.00

USD MSRP (C)

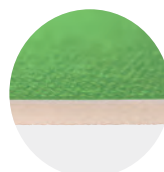

2.4 mm PVC-coated fabric is backed with PVC foam.

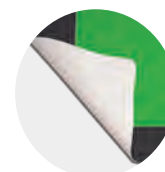

Finished with rounded corners.

Setup fee: \$20.00(G); no setup fee on orders placed via our website; see page 224 for details. View current graphic templates, assembly videos and instructions on our website. See pages 224-226 for additional information that may apply to your order.

FLOOR DECOR MARKETING MAT
3 | **7** DAYS
AFTER FINAL PROOF APPROVAL
PRODUCTION LEAD TIME IS



1. Micro Sail Sign page 165 | 2. Micro GeoMetrix page 154 | 3. Mini Promo Retractor page 164 | 4. Fast Trak page 160

TABLETOP DISPLAYS

When choosing a tabletop display **have you considered...**

- **SIZE** - What is the size of your table?
- **FLEXIBILITY** - Will you be changing the message frequently?
- **FREQUENCY** - How often will you be using the display?
- **TRANSPORT** - How will this display be transported?



2' and 3' kits on a 6' Standard throw (sold separately; see page 10)

EUROFIT TABLETOP STRAIGHT WALL

Everything you love about a EuroFit Straight Wall, featured in three popular tabletop models.

- Artwork is dye sublimated on polyester knit
- Fabric contours to the frame for a form-fitted look
- Lightweight aluminum frame
- Push-button connectors make assembly a snap
- Floor display kits also available (see page 168-175)



EuroFit Tabletop Straight Wall

Item #	Description	1	2-5	6-11	12-24
254603	2'W Kit	167.00	162.00	157.00	152.00
254605	2'W Graphic Cover	64.00	62.00	60.00	58.00
254606	3'W Kit	214.00	207.00	201.00	194.00
254608	3'W Graphic Cover	95.00	92.00	89.00	86.00
254615	6'W Kit	420.00	407.00	395.00	382.00
254617	6'W Graphic Cover	235.00	228.00	221.00	214.00

Kit Includes: Hardware, Graphic Cover, EuroFit Connector and Soft Carry Case USD MSRP (C)

Description	Product Size	Finished Graphic Size	Product Wt.	Media
2'W	24.375"W x 49.5"H x 11.75"D	View Online Template	6.2 lbs.	Polyester Knit
3'W	36.5"W x 49.5"H x 11.75"D	View Online Template	7.6 lbs.	Polyester Knit
6'W	72.25"W x 49.5"H x 11.75"D	View Online Template	9.8 lbs.	Polyester Knit



Ultimate LED Light Kit and EuroFit Light Clamp

Add an Ultimate LED Light Kit to your display using the EuroFit light clamp (sold separately; see page 217). For use on horizontal tubing only.



Setup fee: \$20.00(G); no setup fee on orders placed via our website; see page 224 for details. View current graphic templates, assembly videos and instructions on our website. See pages 224-226 for additional information that may apply to your order.

AFTER FINAL PROOF APPROVAL
PRODUCTION LEAD TIME IS
4DAYS

MICRO GEOMETRIX DISPLAY

Create a variety of multi-dimensional displays in seconds with the Micro GeoMetrix.

- Lightweight aluminum frame with plastic hubs
- Artwork is dye sublimated on polyester double knit
- Additional kits, graphic panels, and hardware available online



Suggested Uses:
Trade Shows
Presentations
Job Fairs
Meetings

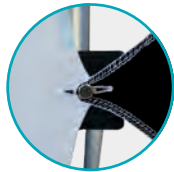

Micro GeoMetrix pegs hold up to three panels each.



Buttonholes are reinforced with white stitching to prevent tearing.

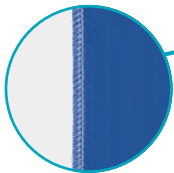

Graphic panels are finished with white stitching.

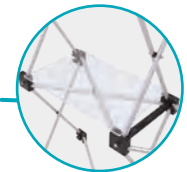

Turn your display into a product merchandiser with the Micro GeoMetrix shelf (sold separately).



Custom configuration shown with two shelves on a 6' Stain Resistant throw and 57" dye-sublimated Accent runner (shelves, throw and runner sold separately)



Micro GeoMetrix Column

Item #	Description	1	2-5	6-11	12-24
337201	Kit	189.00	186.00	183.00	178.00
Kit Includes: Three-Quad Vertical Frame, 3 Graphic Panels and Soft Carry Case		USD MSRP (C)			
Product Size	Finished Graphic Size	Product Wt.	Media		
16.62"W x 46.75"H x 9.62"D	View Online Template	4 lbs.	Polyester Double Knit		



Micro GeoMetrix Grid

Item #	Description	1	2-5	6-11	12-24
337205	Kit	355.00	350.00	345.00	340.00
Kit Includes: Six-Quad Horizontal Frame, 6 Graphic Panels and Soft Carry Case		USD MSRP (C)			
Product Size	Finished Graphic Size	Product Wt.	Media		
46"W x 32.12"H x 9.62"D	View Online Template	6.5 lbs.	Polyester Double Knit		



Micro GeoMetrix Classic

Item #	Description	1	2-5	6-11	12-24
337207	Kit	410.00	405.00	400.00	395.00
Kit Includes: Nine-Quad Square Frame, 5 Graphic Panels and Soft Carry Case		USD MSRP (C)			
Product Size	Finished Graphic Size	Product Wt.	Media		
46"W x 46.75"H x 9.62"D	View Online Template	9.25 lbs.	Polyester Double Knit		



Micro GeoMetrix Centerpoint

Item #	Description	1	2-5	6-11	12-24
337211	Kit	515.00	510.00	505.00	490.00
Kit Includes: Twelve-Quad Horizontal Frame, 8 Graphic Panels and Soft Carry Case		USD MSRP (C)			
Product Size	Finished Graphic Size	Product Wt.	Media		
60.75"W x 46.75"H x 9.62"D	View Online Template	12.5 lbs.	Polyester Double Knit		

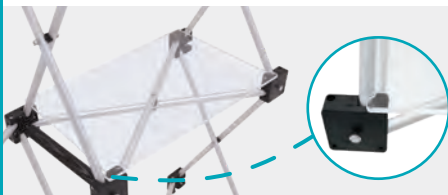

Micro GeoMetrix Shelf

Item #	Description	1	2-5	6-11	12-24
338069	Straight Internal Clear Shelf	36.10	34.30	33.20	31.80
Each shelf supports up to 5 lbs. Compatible with frames equipped with locking arms only.		USD MSRP (C)			

Add-Ons



Ultimate LED Single or Double Light Kit
Item #150120 & 150121
See Page 217

AFTER FINAL PROOF APPROVAL
PRODUCTION LEAD TIME IS
4 DAYS

Setup fee: \$20.00(G); no setup fee on orders placed via our website; see page 224 for details.
View current graphic templates, assembly videos and instructions on our website.
See pages 224-226 for additional information that may apply to your order.

MICRO GEOMETRIX GRAPHIC PANELS

Graphic panels can be ordered separately so you can create a look that's uniquely yours.

- Designed to attach to frame at specific angles (shown below)
- Artwork is dye sublimated on polyester double knit
- Graphic panels are finished with white stitching
- Hardware sold separately (complete frames only; see website for details)



Micro GeoMetrix Graphic Panels

Item #	Description	1
337009	Graphic Panel A	58.00
337010	Graphic Panel B	58.00
337011	Graphic Panel C	58.00
337012	Graphic Panel D	69.00
337013	Graphic Panel E	69.00
337014	Graphic Panel F	93.00
337015	Graphic Panel G	69.00
337016	Graphic Panel H	80.00
337017	Graphic Panel I	69.00
337018	Graphic Panel J	80.00
337019	Graphic Panel K	80.00

Micro GeoMetrix pegs hold up to 3 panels each. USD MSRP (C)
View online templates for finished graphic sizes.

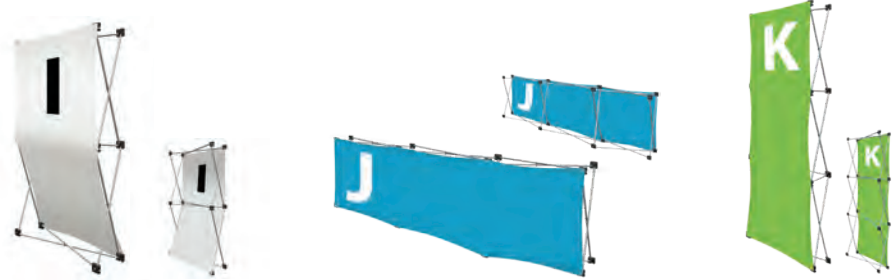

Graphic panels shown on partial frames for illustrative purposes only.
Partial frames not available for purchase.

MICRO GEOMETRIX BACK WALL

Block out distractions with a stylish backdrop.

- Stretches over any nine-quad or twelve-quad Micro GeoMetrix frame (Micro GeoMetrix frames sold separately; available online)
- Artwork is dye sublimated on polyester double knit
- Printed on one side of the fabric only



Micro GeoMetrix Back Wall

Item #	Description	1	2-5	6-11	12-24
337240	Nine-Quad Back Wall	236.00	232.00	224.00	220.00
337241	Twelve-Quad Back Wall	324.00	318.00	308.00	302.00

Micro GeoMetrix pegs hold up to 3 panels each. USD MSRP (C)
View online templates for finished graphic sizes.

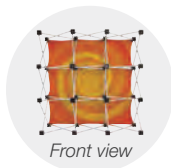

Back wall is printed single-sided with the reverse image showing through the back.

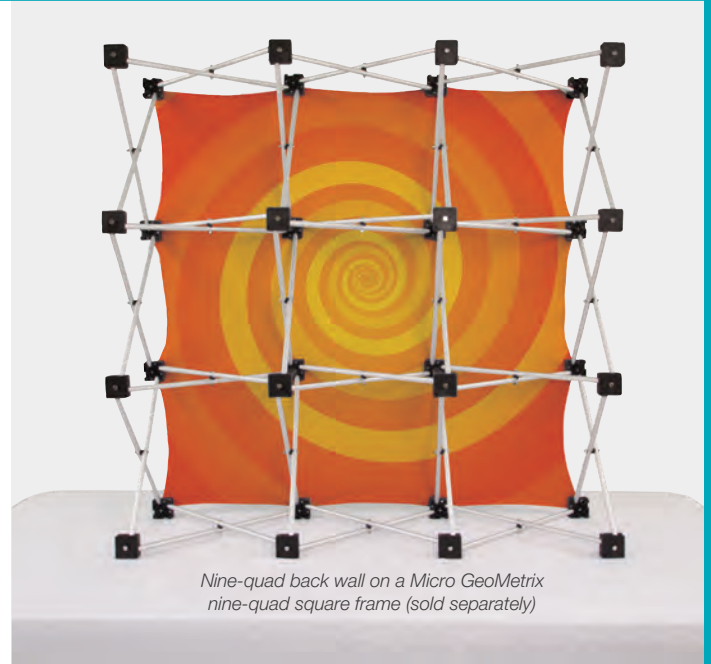
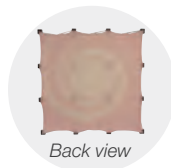

Nine-quad back wall on a Micro GeoMetrix nine-quad square frame (sold separately)

Setup fee: \$20.00(G); no setup fee on orders placed via our website; see page 224 for details.
View current graphic templates, assembly videos and instructions on our website.
See pages 224-226 for additional information that may apply to your order.

AFTER FINAL PROOF APPROVAL
PRODUCTION LEAD TIME IS
4DAYS

SPLASH TABLETOP DISPLAY

This display assembles in minutes and is easily transportable between events.

- Lightweight aluminum frame
- Hook-and-loop-compatible hubs for easy graphic panel installation
- Graphic panel available in polyester knit or block-out fabric
- Available in straight or curved versions
- Floor display kits also available (see page 188-189)
- US Patent #9214104



Suggested Uses:
Trade Shows
Meetings
Museums
Hospitality



Straight face kit on an 6' Standard throw (sold separately; see page 10)



Curved wrap kit on an 6' Standard throw (sold separately; see page 10)



Block-Out Fabric

Block-out fabric is designed to prevent light from showing through the display. It is a good option for brightly lit areas.



High-grade aluminum frame with bayonet locking system keeps the display stable.



Graphic panels install using hook-and-loop fasteners.

Straight Splash Tabletop Display

Item #	Description	1	2-5	6-11	12-24
341000	6' Polyester Knit Face Kit	675.00	655.00	635.00	615.00
342226	6' Block-Out Fabric Face Kit	764.00	741.00	718.00	696.00
341002	6' Polyester Knit Face Graphic Panel	345.00	335.00	325.00	315.00
342228	6' Block-Out Fabric Face Graphic Panel	435.00	425.00	415.00	405.00
341001	6' Polyester Knit Wrap Kit	835.00	815.00	795.00	775.00
342227	6' Block-Out Fabric Wrap Kit	920.00	900.00	875.00	855.00
341003	6' Polyester Knit Wrap Graphic Panel	490.00	475.00	460.00	445.00
342229	6' Block-Out Fabric Wrap Graphic Panel	585.00	575.00	555.00	545.00

Kit Includes: Frame, Graphic Panel and Soft Carry Case
USD MSRP (C)

Curved Splash Tabletop Display

Item #	Description	1	2-5	6-11	12-24
341012	6' Polyester Knit Face Kit	680.00	660.00	640.00	620.00
342230	6' Block-Out Fabric Face Kit	770.00	745.00	725.00	700.00
341014	6' Polyester Knit Face Graphic Panel	345.00	335.00	325.00	315.00
342232	6' Block-Out Fabric Face Graphic Panel	435.00	425.00	415.00	405.00
341013	6' Polyester Knit Wrap Kit	835.00	815.00	795.00	770.00
342231	6' Block-Out Fabric Wrap Kit	920.00	900.00	875.00	850.00
341015	6' Polyester Knit Wrap Graphic Panel	490.00	480.00	470.00	460.00
342233	6' Block-Out Fabric Wrap Graphic Panel	585.00	575.00	555.00	545.00

Kit Includes: Frame, Graphic Panel and Soft Carry Case
USD MSRP (C)

Description	Product Size	Finished Graphic Size	Product Wt. (Face / Wrap)
Straight	61"W x 61"H x 14"D	View Online Template	10.5 lbs. / 11 lbs.
Curved	66"W x 61"H x 18"D	View Online Template	10.5 lbs. / 11 lbs.

AFTER FINAL PROOF APPROVAL
PRODUCTION LEAD TIME IS
3 DAYS

Setup fee: \$20.00(G); no setup fee on orders placed via our website; see page 224 for details.
View current graphic templates, assembly videos and instructions on our website.
See pages 224-226 for additional information that may apply to your order.

Suggested Uses:

- Trade Shows
- Retail Stores
- Presentations
- Conferences

VERGE TABLETOP DISPLAY

This display's fabric graphic panels and well-defined edges bring a sense of style to any tabletop.

- Artwork is dye sublimated on polyester knit
- Silicone edge graphics (SEG) for easy graphic panel installation
- Graphic panels cover three sides of the display
- Heavy-duty aluminum frame pops open like a standard pop-up display
- Floor display kits also available (see page 190)



Verge Tabletop Display

Item #	Description	1	2-5	6-11	12-24
280400	Kit	925.00	890.00	850.00	805.00
Kit Includes: Frame, 3 Graphic Panels and Soft Carry Case		USD MSRP (C)			
Product Size	Finished Graphic Size	Product Wt.	Media		
60.125"W x 60.625"H x 23.25"D	View Online Template	20.25 lbs.	Polyester Knit		



Channel bars slide into grooves in the hubs.



With a quick press of your thumb, the fabric's gasket edge is pushed into the channel bars.



Shown on a 6' Standard throw (sold separately; see page 10)

VERGE GLO TABLETOP DISPLAY

The pleasant glow of this tabletop display will draw all the eyes in the room.

- Artwork is dye sublimated on backlit fabric
- Silicone edge graphics (SEG) for easy graphic panel installation
- Included LED ladder lights attach to the inside of the display using plastic hooks
- Heavy-duty aluminum frame pops open like a standard pop-up display
- Floor display kits also available (see page 191)



Verge Glo Tabletop Display

Item #	Description	1	2-5	6-11	12-24
280401	Kit	1545.00	1495.00	1440.00	1375.00
Kit Includes: Frame, Ladder Lights, 3 Graphic Panels and Soft Carry Cases		USD MSRP (C)			
Product Size	Finished Graphic Size	Product Wt.	Media		
60.125"W x 60.625"H x 23.25"D	View Online Template	33.5 lbs.	Premium Woven Polyester		



With a quick press of your thumb, the fabric's gasket edge is pushed into the channel bars.



LED ladder lights hang inside the display to create an even glow.



Setup fee: \$20.00(G); no setup fee on orders placed via our website; see page 224 for details. View current graphic templates, assembly videos and instructions on our website. See pages 224-226 for additional information that may apply to your order.

AFTER FINAL PROOF APPROVAL
PRODUCTION LEAD TIME IS
4 DAYS



6' kit on a 6' Standard throw (sold separately; see page 10)

EUROFIT BOW TABLETOP DISPLAY

A stylish fabric cover fits over a freestanding frame to create this sleek, upscale display.

- Tubular aluminum frame is lightweight and stable
- Artwork is dye sublimated on polyester knit



EuroFit Bow Tabletop Display

Item #	Description	1	2-5	6-11	12-24
255000	6' Kit	970.00	940.00	910.00	880.00
255002	6' Graphic Cover	605.00	585.00	570.00	550.00
Kit Includes: Hardware, Graphic Cover and Soft Carry Case					USD MSRP (C)

Product Size	Finished Graphic Size	Product Wt.	Media
72"W x 60"H x 15"D	View Online Template	11 lbs.	Polyester Knit



Heavy-duty zipper secures graphic.



Shock cord poles make it easy to set up and tear down.

ARISE TABLETOP DISPLAY

This tabletop pop-up display is specifically engineered for the frequent trade show professional.

- Panels attach to magnet bars for easy alignment
- Ultimate LED Single Light Kit included
- Hard case included
- Floor display kits also available (see page 202-203)



ARISE Tabletop Display

Item #	Description	1	2-5	6-11	12-24
332220	6' Full Fabric Kit	1037.00	1008.00	979.00	951.00
332244	6' Mural with Fabric Ends Kit	1210.00	1150.00	1095.00	1035.00
332252	6' Full Mural Kit	1555.00	1495.00	1440.00	1380.00
332221	8' Full Fabric Kit	1210.00	1150.00	1095.00	1035.00
332245	8' Mural with Fabric Ends Kit	1555.00	1495.00	1440.00	1380.00
332253	8' Full Mural Kit	1905.00	1845.00	1790.00	1730.00
					USD MSRP (C)

Description	Product Size	Finished Graphic Size	Product Wt.	Media
6'	72"W x 62"H x 22"D	View Online Template	52 lbs.	Titan™ No-Curl Laminated Media
8'	94"W x 62"H x 28"D	View Online Template	62 lbs.	Titan™ No-Curl Laminated Media



Self-locking high-grade aluminum frame pops up in seconds.



Magnet bars connect to frame for tool-free assembly.



6' full mural kit on an 8' Standard throw (sold separately; see page 10)

Kit Options



Full Fabric Panel Kit Includes:

- Frame & Magnet Bars
- Fabric Center & End Panels
- Ultimate LED Single Light Kit
- Hard Case with Wheels



Center Mural Panels with Fabric Ends Kit Includes:

- Frame & Magnet Bars
- Mural Center Panels
- Fabric End Panels
- Ultimate LED Single Light Kit
- Hard Case with Wheels



Full Mural Panel Kit Includes:

- Frame & Magnet Bars
- Mural Center & End Panels
- Ultimate LED Single Light Kit
- Hard Case with Wheels

Fabric Colors Charcoal PMS 424 Lava PMS Black 6 Pacific PMS 280 Steel PMS 429

ARISE EUROFIT
AFTER FINAL PROOF APPROVAL
PRODUCTION LEAD TIME IS
3 OR 4 DAYS

ARISE FABRIC ONLY LEAD TIME: SHIPS IN 2 DAYS
Setup fee: \$20.00(G); no setup fee on orders placed via our website; see page 224 for details.
View current graphic templates, assembly videos and instructions on our website.
See pages 224-226 for additional information that may apply to your order.

Suggested Uses:
Point of Purchase
In-Store Demos
Meetings
Charity Events

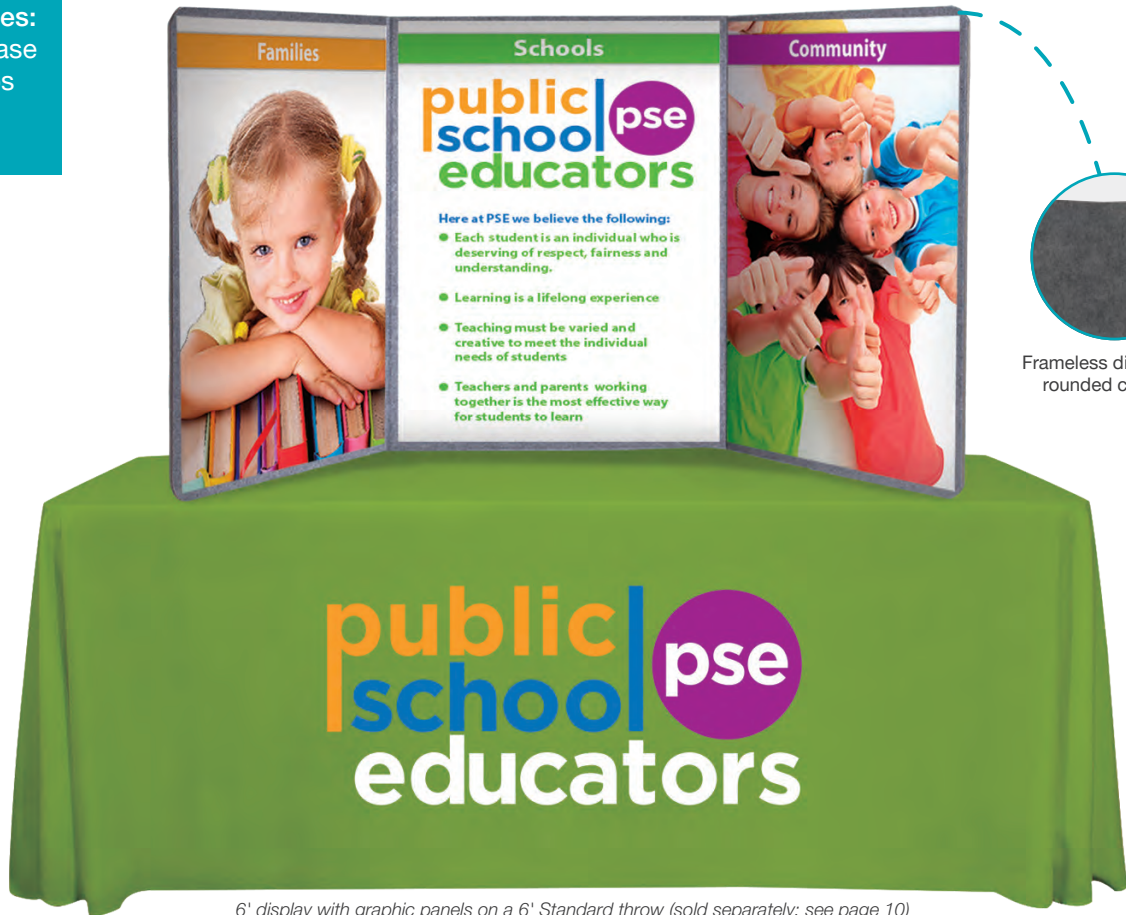

6' display with graphic panels on a 6' Standard throw (sold separately; see page 10)

TABLETOP DISPLAYS

DYNAMO TRIFECTA DISPLAY

Lightweight and affordable, this display is perfect for the budget-conscious marketer.

- Double-acting fabric hinges
- Available in 4' or 6' sizes
- Easy to fold for transportation and storage



Dynamo Trifecta Display

Item #	Description	1	2-5	6-11	12-24
141007	4' Display Only	156.00	150.00	144.00	139.00
141009	4' Display with Graphic Panels	296.00	273.00	250.00	226.00
141008	6' Display Only	179.00	173.00	167.00	162.00
141010	6' Display with Graphic Panels	410.00	385.00	365.00	340.00

USD MSRP (C)

Graphic Panels

Item #	Description	1	2-5	6-11	12-24
190023	4' Body Graphic Panel	71.00	53.00	41.00	36.00
190014	6' Body Graphic Panel	108.00	95.00	84.00	78.00

USD MSRP (C)

Description	Product Size	Finished Graphic Size	Product Wt.	Media
4'	54"W x 24"H x 22"D	17"W x 23"H	5 lbs.	Titan™ No-Curl Laminated Media
6'	72"W x 36"H x 22"D	23"W x 34.75"H	10 lbs.	Titan™ No-Curl Laminated Media

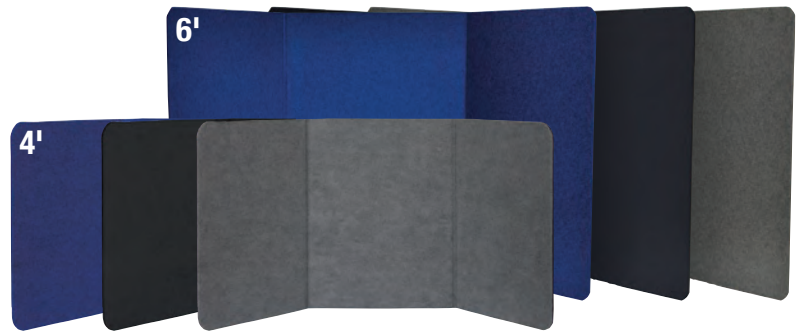

Fabric Colors Blue PMS 2728 Black Gray PMS 422

Display Options

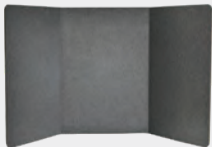

Display Only Includes:

- Display (No Graphic Panels)
- Soft Carry Case



Display with Graphic Panels Includes:

- Display
- 3 Body Graphic Panels
- Soft Carry Case



Hook-and-loop receptive fabric on both sides of the display makes graphic changes quick and easy.

DISPLAY ONLY (NO GRAPHICS) LEAD TIME: SHIPS SAME DAY WHEN ORDERED BEFORE 2 PM

Setup fee: \$20.00(G); no setup fee on orders placed via our website; see page 224 for details.

View current graphic templates, assembly videos and instructions on our website.

See pages 224-226 for additional information that may apply to your order.

AFTER FINAL PROOF APPROVAL
PRODUCTION LEAD TIME IS
3 DAYS

Suggested Uses:
College Recruiting
Trade Shows
Sales Meetings
Presentations



6' display with full graphics on a 6' Standard throw (sold separately; see page 10)

FAST TRAK DISPLAY

Create an eye-catching presentation with this popular, lightweight display.

- Display can be used with graphic panels on both sides
- Hook-and-loop receptive fabric makes graphic panel changes quick and easy
- Seamless design with hidden double-acting hinges
- Available in 4' or 6' sizes
- Easy clip-on header

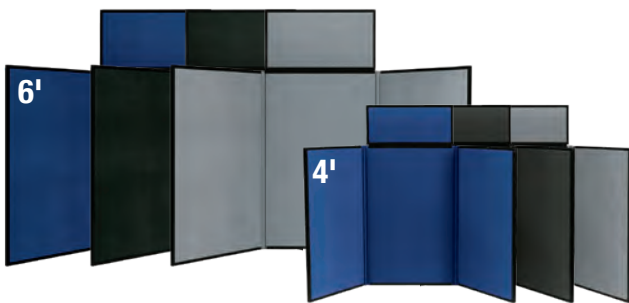

Fabric Colors Blue PMS 287 Black Gray PMS 430

Fast Trak Display

Item #	Description	1	2-5	6-11	12-24
146084	4' Display Only	318.00	306.00	283.00	260.00
146011	4' Display with Header Graphic Panel	365.00	340.00	310.00	275.00
146012	4' Display with Full Graphic Panels	550.00	505.00	450.00	405.00
146085	6' Display Only	355.00	345.00	320.00	300.00
146014	6' Display with Header Graphic Panel	410.00	385.00	355.00	320.00
146015	6' Display with Full Graphic Panels	675.00	630.00	585.00	535.00

USD MSRP (C)

Graphic Panels

Item #	Description	1	2-5	6-11	12-24
190015	4' Header Graphic Panel	60.00	36.00	27.50	22.00
190013	6' Header Graphic Panel	71.00	53.00	41.00	36.00
190017	4' Body Graphic Panel	82.00	65.00	52.00	47.00
190014	6' Body Graphic Panel	108.00	95.00	84.00	78.00

USD MSRP (C)

Description	Product Size	Body Graphic Panel Size	Header Graphic Panel Size	Product Wt.	Media
4'	54"W x 37"H x 22"D	17"W x 27.5"H	17"W x 7"H	10 lbs.	Titan™ No-Curl Laminated Media
6'	72"W x 48"H x 22"D	23"W x 34.75"H	22.75"W x 10.75"H	15 lbs.	Titan™ No-Curl Laminated Media

Display Options



Display Only Includes:

- Display (No Graphic Panels)
- Soft Carry Case



Display with Header Graphic Panel Includes:

- Display
- Header Graphic Panel
- Soft Carry Case



Display with Full Graphic Panels Includes:

- Display
- Header Graphic Panel
- 3 Body Graphic Panels
- Soft Carry Case

3 DAYS
AFTER FINAL PROOF APPROVAL
PRODUCTION LEAD TIME IS

DISPLAY ONLY (NO GRAPHICS) LEAD TIME: SHIPS SAME DAY WHEN ORDERED BEFORE 2 PM

Setup fee: \$20.00(G); no setup fee on orders placed via our website; see page 224 for details.

View current graphic templates, assembly videos and instructions on our website.

See pages 224-226 for additional information that may apply to your order.

Suggested Uses:
Lobby Displays
Product Demos
Presentations
Trade Shows

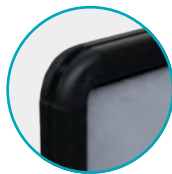

Plastic frame has rounded corners.

Custom configuration shown*



6' display with graphic panels on a 6' Standard throw (sold separately; see page 10)

SHOW 'N WRITE DISPLAY

This unique display features hook-and-loop receptive fabric on one side and dry-erase board on the other, giving you limitless possibilities.

- Graphic panels can be applied to hook-and-loop receptive fabric
- Available in 4' or 6' sizes
- Lightweight and portable



Show 'N Write Display

Item #	Description	1	2-5	6-11	12-24
142004	4' Display Only	296.00	284.00	273.00	261.00
142006	4' Display with Graphic Panels	495.00	435.00	405.00	370.00
142007	6' Display Only	355.00	345.00	330.00	320.00
142009	6' Display with Graphic Panels	665.00	630.00	585.00	550.00

USD MSRP (C)

Graphic Panels

Item #	Description	1	2-5	6-11	12-24
190015	4' Header Graphic Panel	60.00	36.00	27.50	22.00
190013	6' Header Graphic Panel	71.00	53.00	41.00	36.00
190023	4' Body Graphic Panel	71.00	53.00	41.00	36.00
190014	6' Body Graphic Panel	108.00	95.00	84.00	78.00

USD MSRP (C)

Description	Product Size	Body Graphic Panel Size	Header Graphic Panel Size	Product Wt.	Media
4'	54"W x 32"H x 22"D	17"W x 23"H	17"W x 7"H	12 lbs.	Titan™ No-Curl Laminated Media
6'	72"W x 48"H x 30"D	23"W x 34.75"H	22.75"W x 10.75"H	20 lbs.	Titan™ No-Curl Laminated Media

*On a standard Show 'N Write display, all four sections are laid out with the dry-erase board facing the same direction. Graphic panels attach to the opposite, fabric side. See instructional video for details on setting up a custom configuration (like the one shown above).



Fabric Colors ■ Blue PMS 2728 ■ Black ■ Gray PMS 422

Display Options

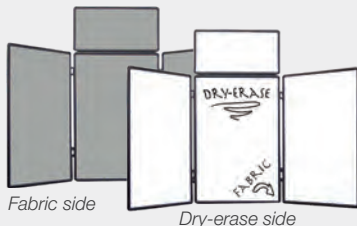

Display Only Includes:

- Display (No Graphic Panels)
- Soft Carry Case



Display with Graphic Panels Includes:

- Display
- Header Graphic Panel
- 3 Body Graphic Panels
- Soft Carry Case

DISPLAY ONLY (NO GRAPHICS) LEAD TIME: SHIPS SAME DAY WHEN ORDERED BEFORE 2 PM

Setup fee: \$20.00(G); no setup fee on orders placed via our website; see page 224 for details.

View current graphic templates, assembly videos and instructions on our website.

See pages 224-226 for additional information that may apply to your order.

AFTER FINAL PROOF APPROVAL
PRODUCTION LEAD TIME IS
3 DAYS

Frame converts from 74.5" to 98"W



6' Header kit on a 6' UltraFit Curve throw (sold separately; see page 14)

Frame converts from 44" to 68.25"H



OVER-THE-TOP DISPLAY

Create an overhead banner or a stylish backdrop by simply clamping this display to a table.

- Artwork is dye sublimated on polyester knit
- Double-sided cover is viewable from both the front and back of the display
- Lightweight, durable carbon composite poles with aluminum corners



Over-The-Top Display

Item #	Description	1	2-5	6-11	12-24
280320	6' Header Kit	385.00	375.00	360.00	350.00
280321	8' Header Kit	410.00	400.00	385.00	375.00
280322	6' Short Back Wall Kit	425.00	415.00	400.00	390.00
280323	8' Short Back Wall Kit	455.00	445.00	430.00	420.00
280324	6' Tall Back Wall Kit	455.00	445.00	430.00	420.00
280325	8' Tall Back Wall Kit	475.00	465.00	450.00	440.00
280331	Two Floor Bases with Pole Posts	93.00	87.00	81.00	76.00

Kit Includes: Frame, Graphic Cover and Soft Carry Case USD MSRP (C)

Description	Product Size	Finished Graphic Size	Product Wt.	Media
6' Header	74.5"W x 44" or 68.25"H x 2.875"D	View Online Template	9.75 lbs.	Polyester Knit
8' Header	98"W x 44" or 68.25"H x 2.875"D	View Online Template	10 lbs.	Polyester Knit
6' Short Back Wall	74.5"W x 44"H x 2.875"D	View Online Template	11 lbs.	Polyester Knit
8' Short Back Wall	98"W x 44"H x 2.875"D	View Online Template	11.75 lbs.	Polyester Knit
6' Tall Back Wall	74.5"W x 68.25"H x 2.875"D	View Online Template	12 lbs.	Polyester Knit
8' Tall Back Wall	98"W x 68.25"H x 2.875"D	View Online Template	13.25 lbs.	Polyester Knit

Kit Options



Shown on UltraFit throw (sold separately). Table not included.



The easy-to-use clamp system attaches to any table up to 2.5" thick. No tools required.



Use as a freestanding display by adding floor bases (sold separately, available online).

AFTER FINAL PROOF APPROVAL
PRODUCTION LEAD TIME IS
4 DAYS

HARDWARE ONLY LEAD TIME: SHIPS SAME DAY WHEN ORDERED BEFORE 2 PM
Setup fee: \$20.00(G); no setup fee on orders placed via our website; see page 224 for details.
View current graphic templates, assembly videos and instructions on our website.
See pages 224-226 for additional information that may apply to your order.

Suggested Uses:

- Job Fairs
- Fundraisers
- Registrations
- Trade Shows



6' kit on a 6' Economy throw (sold separately; see page 8)

EUROFIT MONARCH

A curved overhead display is complemented by wing panels that create enormous amounts of ad space.

- Artwork is dye sublimated on polyester knit
- All graphic covers are double-sided
- Heavy-duty zipper keeps the graphic cover secure and taut
- Lightweight aluminum frame
- Joints are labeled for step-by-step frame assembly
- Push-button connectors make assembly a snap



EuroFit Monarch

Item #	Description	1	2-5	6-11	12-24
280350	6' Kit	412.00	397.00	380.40	367.40
280353	8' Kit	619.00	593.00	569.40	549.40

Kit Includes: Hardware, 3 Graphic Covers and Soft Carry Case USD MSRP (C)

Description	Product Size	Finished Graphic Size	Product Wt.	Media
6'	107.625"W x 67.125"H x 7"D	View Online Template	20.5 lbs.	Polyester Knit
8'	132"W x 67.125"H x 7"D	View Online Template	21.5 lbs.	Polyester Knit

Ultimate LED Light Kit and EuroFit Light Clamp

Add an Ultimate LED Light Kit to your display using the EuroFit light clamp (sold separately; see page 217).
For use on horizontal tubing only.



The easy-to-use clamp system attaches to any table up to 2.5" thick. No tools required.



Wings attach using EuroFit Connectors (two per wing, US Patent #9637963).



Hinged EuroFit Connectors allow the wings to swivel.

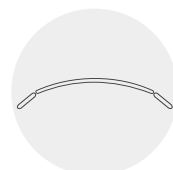

Top view

Setup fee: \$20.00(G); no setup fee on orders placed via our website; see page 224 for details. View current graphic templates, assembly videos and instructions on our website. See pages 224-226 for additional information that may apply to your order.

AFTER FINAL PROOF APPROVAL
PRODUCTION LEAD TIME IS
4 DAYS



MagnaLink

Deluxe Mini

Large Mini Promo

Small Mini Promo

Economy

Magnetic end caps let you align multiple units.

Flip-open base discreetly hides the banner when not in use.

Lightweight aluminum base is easy to move.

Hardware available in silver or black.

MINI RETRACTORS

These mini retractors can be used even when space is limited.

- Compact size
- Lightweight and portable
- Warranties range between six months and three years (see Retractable Banner Comparison Chart on page 27 for details)



Deluxe Mini Retractor

Item #	Description	1	2-5	6-11	12-24
262014	Kit	60.00	58.75	57.25	56.00

Kit Includes: Hardware and Installed Banner USD MSRP (C)

Mini Promo Retractors

Item #	Description	1	2-5	6-11	12-24
210240	Small Kit	46.50	44.00	43.00	41.00
210242	Large Kit	52.00	49.50	48.00	46.00

Kit Includes: Hardware and Installed Banner USD MSRP (C)

Description	Product Size	Finished Graphic Size	Product Wt.	Media
Deluxe Mini	9.375"W x 17.75"H x 4"D	8.25"W x 16.25"H	1.5 lbs.	Titan™ Polypropylene Media
Small Mini Promo	9.625"W x 13.25"H x 3"D	8.25"W x 12"H	1 lb.	Titan™ Polypropylene Media
Large Mini Promo	13.125"W x 17.875"H x 3"D	11.75"W x 16.5"H	1 lb.	Titan™ Polypropylene Media

Economy Tabletop Retractor

Item #	Description	1	2-5	6-11	12-24
261130	Titan™ No-Curl Hybrid Media Kit	173.00	161.00	150.00	138.00
262160	Titan™ No-Curl Opaque Fabric Kit	173.00	161.00	150.00	138.00

Kit Includes: Black or Silver Hardware, Installed Banner and Soft Carry Case USD MSRP (C)

MagnaLink Tabletop Retractor

Item #	Description	1	2-5	6-11	12-24
261195	Kit	230.00	216.00	205.00	191.00

Kit Includes: Hardware, Installed Banner and Soft Carry Case USD MSRP (C)

Description	Product Size	Finished Graphic Size	Product Wt.	Media
Economy	24.75"W x 39"H x 11"D	24"W x 35.5"H	5.25 lbs.	See Kit Description
MagnaLink	17.25"W x 44"-51.75"H x 8.5"D	15.75"W x 42.25"-50"H	6.2 lbs.	Titan™ No-Curl Fabric

24 DAYS
MAGNALINK
AFTER FINAL PROOF APPROVAL
PRODUCTION LEAD TIME IS

Setup fee: \$20.00(G); no setup fee on orders placed via our website; see page 224 for details.
View current graphic templates, assembly videos and instructions on our website.
See pages 224-226 for additional information that may apply to your order.



Fold-out feet for a small, stable footprint.

Aluminum frame features push-button connections and square plastic corners.

X-shaped frame features four tension rods that keep the banner taut.

Wood available in light brown or espresso.

Flag features a pole pocket that slides over the top arm.

Two-piece, flexible carbon composite pole twists into aluminum base.

MINI DISPLAYS

These displays fit into small areas, making them perfect for tables and countertops.

- Lightweight and portable
- Warranties range between six and twelve months (see website for details)



EuroFit Mini Display

Item #	Description	1	2-5	6-11	12-24
280370	Double-Sided Kit	77.30	75.00	72.60	70.40

Kit Includes: Hardware, Graphic Cover and Soft Carry Case
USD MSRP (C)

Micro Teardrop Sail Sign

Item #	Description	1	5	6-11	12-24
191540	Single-Sided Kit	NA	41.60	39.50	38.20
191541	Double-Sided Kit	NA	66.80	63.40	61.30

Kit Includes: Hardware, Flag and Carry Pouch
USD MSRP (C)

Monopode Tabletop Display

Item #	Description	1	2-5	6-11	12-24
210245	Single-Sided Kit	112.80	106.10	100.30	93.60
210296	Double-Sided Kit	156.00	147.00	139.00	129.00

Kit Includes: Hardware, Banner, Steel Dowel and 2 Soft Carry Cases
USD MSRP (C)

Description	Product Size	Finished Graphic Size	Product Wt.	Media
EuroFit Mini	12.875"W x 18.625"H x 11"D	View Online Template	2.25 lbs.	Polyester Knit
Micro Teardrop	9"W x 17.5"H x 3.125"D	View Online Template	3.9 oz.	Super Poly Knit Fabric
Monopode Tabletop	14.5"W x 39.25"H x 11.75"D	12"W x 29.5"H	3.8 lbs.	Super Poly Knit Fabric

Countertop Wood Chalkboards

Item #	Description	1	2-5	6-11	12-24
263360	Small Double-Sided Kit	43.40	42.10	40.10	39.10
263363	Large Double-Sided Kit	48.50	47.00	44.80	43.60

Kit Includes: Espresso or Light Brown Hardware and 2 Header Decals
USD MSRP (C)

FrameWorx Tabletop Banner Display

Item #	Description	1	2-5	6-11	12-24
263081	13 oz. Smooth Scrim Vinyl Single-Sided Kit	101.60	96.60	93.40	89.40
263082	13 oz. Smooth Scrim Vinyl Double-Sided Kit	118.60	112.70	109.10	104.40
263084	No-Curl Opaque Fabric Single-Sided Kit	129.80	123.40	119.40	114.20

Kit Includes: Black or Silver Hardware, Banner and Soft Carry Case
USD MSRP (C)

Mini X Banner Display

Item #	Description	1	2-5	6-11	12-24
210032	Kit	29.90	28.40	27.50	26.30

Kit Includes: Hardware, Banner and Drawstring Pouch
USD MSRP (C)

Description	Product Size	Finished Graphic Size	Product Wt.	Media
Small Chalkboard	7.75"W x 9.125"H x 2.375"D	5.8125"W x 2"H	0.6 lb.	Surface Grip
Large Chalkboard	10.125"W x 12.625"H x 2.375"D	8.1875"W x 2.5"H	0.8 lb.	Surface Grip
FrameWorx Tabletop	37.125"W x 45"H x 15.375"D	23.5"W x 37.75"H	5.25 lbs.	See Kit Description
Mini X	11.75"W x 18"H x 10.75"D	11"W x 17"H	0.5 lb.	Titan™ No-Curl Laminated Media

Setup fee: \$20.00(G); no setup fee on orders placed via our website; see page 224 for details. View current graphic templates, assembly videos and instructions on our website. See pages 224-226 for additional information that may apply to your order.





1. Splash page 188 | 2. EuroFit Wall page 169 | 3. Deluxe GeoMetrix page 194

FLOOR DISPLAYS

When choosing a floor display **have you considered...**

- **SIZE** - What is the size of your space?
- **FREQUENCY** - How often will you be setting up and taking down your display?
- **TRANSPORT** - How will this display be transported?
- **FLEXIBILITY** - Will you be changing out your look and message frequently?
- **ACCESSORIES** - Do you need lights for your display, and will power be available?

EUROFIT DISPLAY

VERSATILE. MODULAR. CONNECTED.

Fabric contours to the frame for a form-fitted look.

Personalize your display by adding accessories (sold separately; see pages 170-172).

Slim swivel feet allow units to be paired at angles.

EuroFit Connector holds individual units together.

Tubular aluminum frame is lightweight and stable.

EUROFIT FEATURES & BENEFITS

Joints are labeled for accurate step-by-step frame assembly.

Push-button connectors make assembly easy.

Select displays feature a heavy-duty zipper that secures the graphic cover.

US Patent #9637963

Compatible displays can be hinged together using the EuroFit Connector.

Soft carry case included with all kits.

EASE OF SETUP

Double-sided graphic covers easily slide on and off.

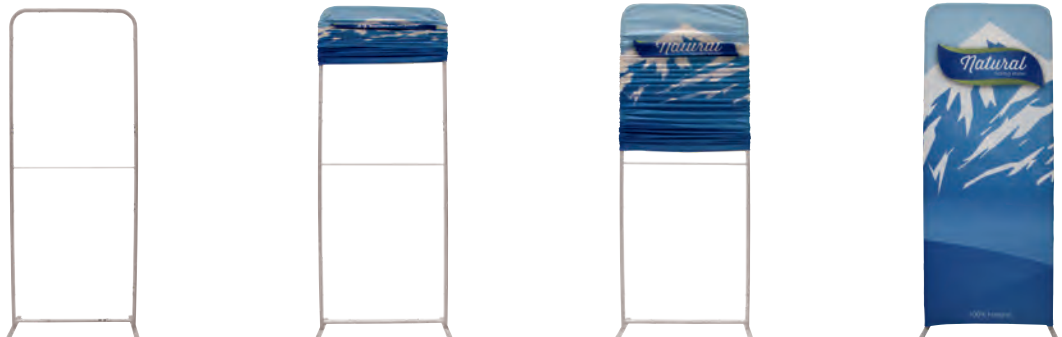

EUROFIT WALLS

The ever-expanding EuroFit line offers many elegant and versatile display solutions.

- Artwork is vibrantly dye sublimated on polyester knit



Suggested Uses:
Trade Shows
Job Fairs
Office Spaces
Retail Installations



EuroFit Arc Wall

Item #	Description	1	2-5	6-11	12-24
256270	2'W Kit	247.00	240.00	232.00	225.00
256272	2'W Graphic Cover	112.00	109.00	105.00	102.00
256273	3'W Kit	332.00	322.00	313.00	302.00
256275	3'W Graphic Cover	174.00	169.00	164.00	158.00
256276	4'W Kit	433.00	420.00	407.00	394.00
256278	4'W Graphic Cover	230.00	223.00	216.00	209.00
256279	5'W Kit	500.00	485.00	471.00	455.00
256281	5'W Graphic Cover	275.00	267.00	259.00	250.00
256282	8'W Kit	760.00	737.00	714.00	692.00
256284	8'W Graphic Cover	394.00	382.00	370.00	359.00

Kit Includes: Hardware, Graphic Cover, EuroFit Connector and Soft Carry Case USD MSRP (C)

Description	Product Size	Finished Graphic Size	Product Wt.	Media
2'W	24.5"W x 91.25"H x 19"D	View Online Template	9 lbs.	Polyester Knit
3'W	36.5"W x 91.25"H x 19"D	View Online Template	9.75 lbs.	Polyester Knit
4'W	48.5"W x 91.25"H x 19"D	View Online Template	12 lbs.	Polyester Knit
5'W	60.5"W x 91.25"H x 19"D	View Online Template	13.5 lbs.	Polyester Knit
8'W	96.5"W x 91.25"H x 19"D	View Online Template	17 lbs.	Polyester Knit

EuroFit Incline Wall

Item #	Description	1	2-5	6-11	12-24
256320	2'W Kit	247.00	240.00	232.00	225.00
256322	2'W Graphic Cover	112.00	109.00	105.00	102.00
256323	3'W Kit	332.00	322.00	313.00	302.00
256325	3'W Graphic Cover	174.00	169.00	164.00	158.00
256326	4'W Kit	433.00	420.00	407.00	394.00
256328	4'W Graphic Cover	230.00	223.00	216.00	209.00
256329	5'W Kit	500.00	485.00	471.00	455.00
256331	5'W Graphic Cover	275.00	267.00	259.00	250.00
256332	8'W Kit	760.00	737.00	714.00	692.00
256334	8'W Graphic Cover	394.00	382.00	370.00	359.00

Kit Includes: Hardware, Graphic Cover, EuroFit Connector and Soft Carry Case USD MSRP (C)

Description	Product Size	Finished Graphic Size	Product Wt.	Media
2'W	24.5"W x 91"H x 19"D	View Online Template	9.25 lbs.	Polyester Knit
3'W	36.5"W x 91"H x 19"D	View Online Template	10 lbs.	Polyester Knit
4'W	48.5"W x 91"H x 19"D	View Online Template	12.5 lbs.	Polyester Knit
5'W	60.5"W x 91"H x 19"D	View Online Template	14 lbs.	Polyester Knit
8'W	96.5"W x 91"H x 19"D	View Online Template	18 lbs.	Polyester Knit

Add-Ons



EuroFit Light Clamp

Item #	Description	1	2-5	6-11	12-24
255125	Light Clamp	5.40	5.20	5.10	4.90

Clamp only. Ultimate LED Light Kit sold separately; see page 217.

For use on horizontal tubing only.



EuroFit Connector

US Patent #9637963

Item #	Description	1	2-5	6-11	12-24
255122	Connector	5.80	5.60	5.50	5.30

Included with most EuroFit kits
See Kit Includes details USD MSRP (C)

AFTER FINAL PROOF APPROVAL
PRODUCTION LEAD TIME IS
4 DAYS

HARDWARE ONLY LEAD TIME: SHIPS SAME DAY WHEN ORDERED BEFORE 2 PM CENTRAL

Setup fee: \$20.00(G); no setup fee on orders placed via our website; see page 224 for details.

View current graphic templates, assembly videos and instructions on our website.

See pages 224-226 for additional information that may apply to your order.

54"H EuroFit Straight Wall

Item #	Description	1	2-5	6-11	12-24
256200	2'W Kit	179.00	174.00	168.00	163.00
256202	2'W Graphic Cover	67.00	65.00	63.00	61.00
256209	3'W Kit	225.00	218.00	211.00	204.00
256211	3'W Graphic Cover	97.00	94.00	91.00	88.00
256218	4'W Kit	275.00	267.00	258.00	250.00
256220	4'W Graphic Cover	128.00	124.00	120.00	116.00
256227	5'W Kit	329.00	319.00	310.00	299.00
256229	5'W Graphic Cover	174.00	169.00	164.00	158.00
256236	8'W Kit	458.00	445.00	430.00	417.00
256238	8'W Graphic Cover	249.00	242.00	234.00	227.00

Kit Includes: Hardware, Graphic Cover, EuroFit Connector and Soft Carry Case USD MSRP (C)

Description	Product Size	Finished Graphic Size	Product Wt.	Media
2'W	24.5"W x 54"H x 19"D	View Online Template	6.6 lbs.	Polyester Knit
3'W	36.5"W x 54"H x 19"D	View Online Template	7.5 lbs.	Polyester Knit
4'W	48.5"W x 54"H x 19"D	View Online Template	8.25 lbs.	Polyester Knit
5'W	60.5"W x 54"H x 19"D	View Online Template	9.25 lbs.	Polyester Knit
8'W	96.5"W x 54"H x 19"D	View Online Template	13.8 lbs.	Polyester Knit



72"H EuroFit Straight Wall

Item #	Description	1	2-5	6-11	12-24
256203	2'W Kit	208.00	201.00	196.00	189.00
256205	2'W Graphic Cover	85.00	82.00	80.00	77.00
256212	3'W Kit	275.00	264.00	253.00	238.00
256214	3'W Graphic Cover	128.00	121.00	115.00	104.00
256221	4'W Kit	348.00	337.00	327.00	316.00
256223	4'W Graphic Cover	185.00	179.00	174.00	168.00
256230	5'W Kit	433.00	420.00	407.00	394.00
256232	5'W Graphic Cover	230.00	223.00	216.00	209.00
256239	8'W Kit	586.00	568.00	551.00	533.00
256241	8'W Graphic Cover	332.00	322.00	312.00	302.00

Kit Includes: Hardware, Graphic Cover, EuroFit Connector and Soft Carry Case USD MSRP (C)

Description	Product Size	Finished Graphic Size	Product Wt.	Media
2'W	24.5"W x 72"H x 19"D	View Online Template	7.5 lbs.	Polyester Knit
3'W	36.5"W x 72"H x 19"D	View Online Template	8.25 lbs.	Polyester Knit
4'W	48.5"W x 72"H x 19"D	View Online Template	9.5 lbs.	Polyester Knit
5'W	60.5"W x 72"H x 19"D	View Online Template	11 lbs.	Polyester Knit
8'W	96.5"W x 72"H x 19"D	View Online Template	15.5 lbs.	Polyester Knit



90"H EuroFit Straight Wall

Item #	Description	1	2-5	6-11	12-24
256206	2'W Kit	247.00	240.00	232.00	225.00
256208	2'W Graphic Cover	112.00	109.00	105.00	102.00
256215	3'W Kit	332.00	322.00	313.00	302.00
256217	3'W Graphic Cover	174.00	169.00	164.00	158.00
256224	4'W Kit	433.00	420.00	407.00	394.00
256226	4'W Graphic Cover	230.00	223.00	216.00	209.00
256233	5'W Kit	500.00	485.00	471.00	455.00
256235	5'W Graphic Cover	275.00	267.00	259.00	250.00
255180	8'W Kit	760.00	737.00	714.00	692.00
255182	8'W Graphic Cover	394.00	382.00	370.00	359.00
256251	10'W Kit	1335.00	1310.00	1270.00	1245.00
256253	10'W Graphic Cover	800.00	785.00	760.00	745.00
256427	20'W Kit	2635.00	2605.00	2505.00	2475.00
256429	20'W Graphic Cover	1585.00	1555.00	1505.00	1475.00

Kit Includes: Hardware, Graphic Cover, EuroFit Connector and Soft Carry Case USD MSRP (C)

20' Display Includes: Hardware, Graphic Cover, 2 EuroFit Connectors and 2 Soft Carry Cases

Description	Product Size	Finished Graphic Size	Product Wt.	Media
2'W	24.5"W x 91.25"H x 19"D	View Online Template	9.25 lbs.	Polyester Knit
3'W	36.5"W x 91.25"H x 19"D	View Online Template	10.3 lbs.	Polyester Knit
4'W	48.5"W x 91.25"H x 19"D	View Online Template	11.4 lbs.	Polyester Knit
5'W	60.5"W x 91.25"H x 19"D	View Online Template	12.6 lbs.	Polyester Knit
8'W	96.5"W x 91.25"H x 19"D	View Online Template	18 lbs.	Polyester Knit
10'W	115.5"W x 91.25"H x 19"D	View Online Template	21.25 lbs.	Polyester Knit
20'W	231"W x 91.25"H x 19"D	View Online Template	42.75 lbs.	Polyester Knit



120"H EuroFit Straight Wall

Item #	Description	1	2-5	6-11	12-24
256512	8'W Kit	900.00	882.00	855.00	837.00
256514	8'W Graphic Cover	480.00	470.00	455.00	445.00
256515	10'W Kit	1440.00	1411.00	1368.00	1339.00
256517	10'W Graphic Cover	875.00	860.00	830.00	815.00

Kit Includes: Hardware, Graphic Cover, EuroFit Connector and Soft Carry Case USD MSRP (C)

Description	Product Size	Finished Graphic Size	Product Wt.	Media
8'W	96"W x 119.5"H x 29"D	View Online Template	18.5 lbs.	Polyester Knit
10'W	115.25"W x 119.5"H x 29"D	View Online Template	22.5 lbs.	Polyester Knit

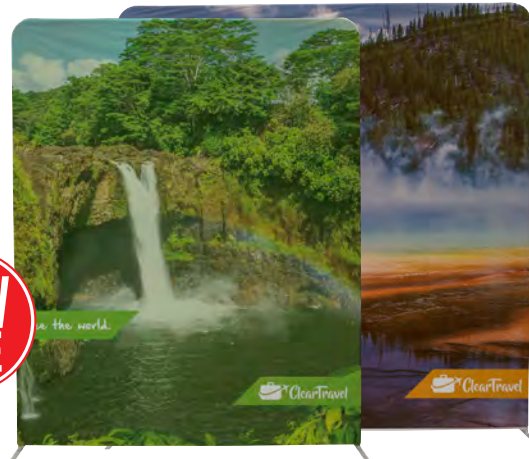

Setup fee: \$20.00(G); no setup fee on orders placed via our website; see page 224 for details.
View current graphic templates, assembly videos and instructions on our website.
See pages 224-226 for additional information that may apply to your order.

AFTER FINAL PROOF APPROVAL
PRODUCTION LEAD TIME IS
4 DAYS

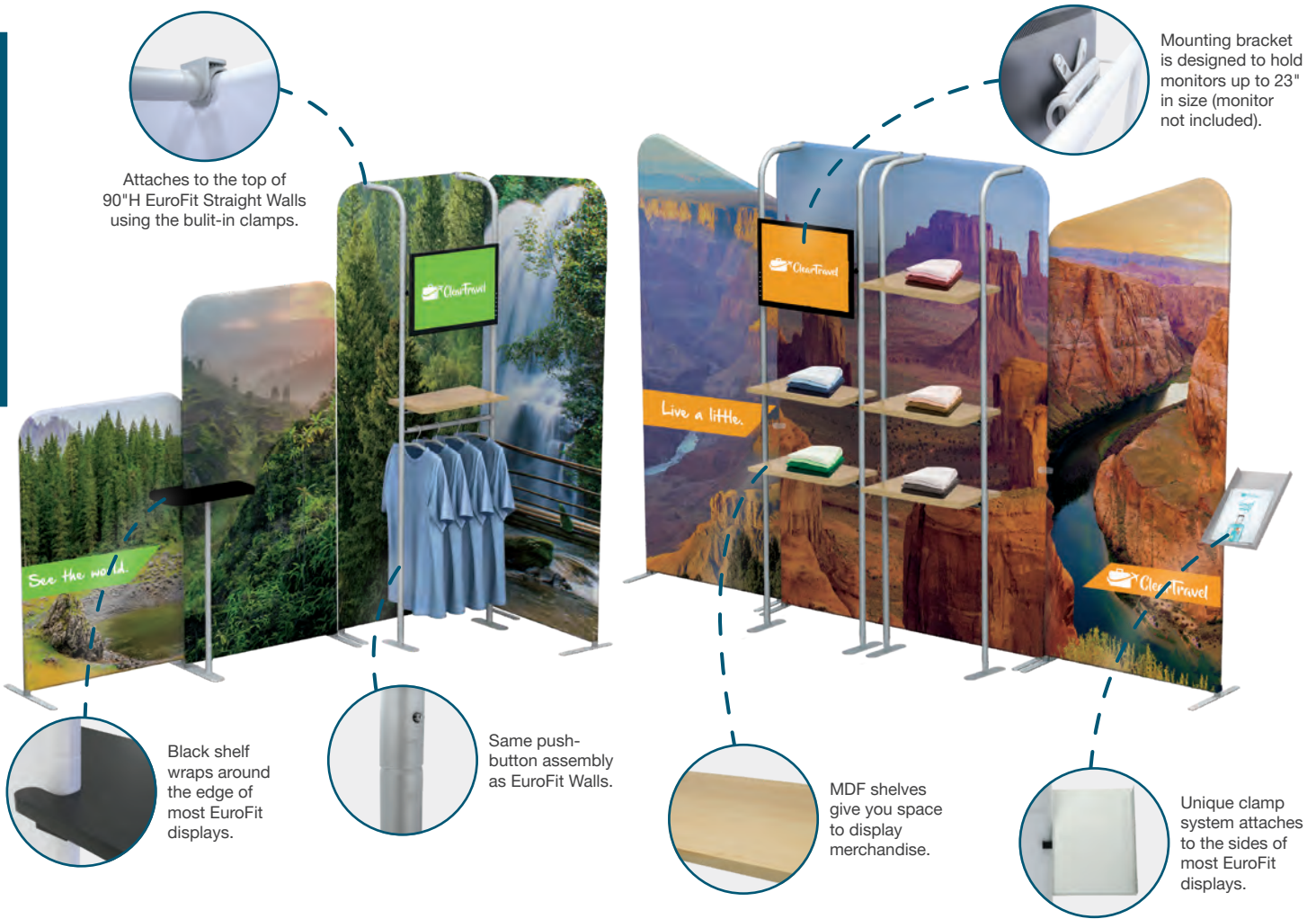

EUROFIT WALL ACCESSORIES



EuroFit Wall Shelf

Item #	Description	Product Wt.	1	2-5	6-11	12-24
255123	Left Shelf Kit	7.5 lbs.	130.00	126.00	122.00	118.00
255124	Right Shelf Kit	7.5 lbs.	130.00	126.00	122.00	118.00

Kit Includes: Hardware and Soft Carry Case
Shelves support up to 10 lbs. USD MSRP (C)

EuroFit Literature Holder

Item #	Description	Product Wt.	1	2-5	6-11	12-24
255127	Literature Holder	4.2 lbs.	55.00	53.00	52.00	50.00

Literature holder supports up to 5 lbs. USD MSRP (C)

EuroFit Cascade

Item #	Description	Product Wt.	1	2-5	6-11	12-24
256400	Kit	11.5 lbs.	393.00	381.00	370.00	358.00

Kit Includes: Hardware, Graphic Cover, EuroFit Connector and Soft Carry Case
Compatible with 90"H EuroFit Straight Walls (sold separately). Will not work with 2'W Straight Walls.
View online templates for finished graphic sizes. USD MSRP (C)

EuroFit Cascade Merchandiser

Item #	Description	Product Wt.	1	2-5	6-11	12-24
256390	Hanger Merchandiser Kit	14.4 lbs.	380.00	370.00	360.00	355.00
256391	Two-Shelf Merchandiser Kit	19 lbs.	380.00	370.00	360.00	355.00
256392	Three-Shelf Merchandiser Kit	22.5 lbs.	380.00	370.00	360.00	355.00

Kit Includes: Hardware and Soft Carry Case
Compatible with 90"H EuroFit Straight Walls (sold separately). Will not work with 2'W Straight Walls.
Shelves support up to 5 lbs., hanger supports up to 10 lbs.
Recommended monitor size up to 23". USD MSRP (C)



EuroFit accessories shown on 90"H EuroFit Straight Walls (sold separately)

AFTER FINAL PROOF APPROVAL
PRODUCTION LEAD TIME IS
4 DAYS

HARDWARE ONLY LEAD TIME: SHIPS SAME DAY WHEN ORDERED BEFORE 2 PM CENTRAL
Setup fee: \$20.00(G); no setup fee on orders placed via our website; see page 224 for details.
View current graphic templates, assembly videos and instructions on our website.
See pages 224-226 for additional information that may apply to your order.

EUROFIT OVERLAP

Create a dynamic, three-dimensional look by adding the EuroFit Overlap to an existing 90"H EuroFit Straight Wall.

- Artwork is vibrantly dye sublimated on polyester knit
- Recommended for use with 4'W Straight Walls and wider
- Orientation can be upward or downward
- EuroFit Straight Wall sold separately (see page 169)



EuroFit Overlap

Item #	Description	1	2-5	6-11	12-24
256480	Kit	458.00	446.00	435.00	423.00
256482	Graphic Cover	240.00	235.00	230.00	225.00
Kit Includes: Hardware, Graphic Cover, Connector Bars and Soft Carry Case				USD MSRP (C)	
Product Size	Finished Graphic Size	Product Wt.	Media		
48.5"W x 96"H x 19"D	View Online Template	12.25 lbs.	Polyester Knit		



Attaches to Straight Wall using connector bars included in kit.

Shown in upward orientation on 10' Straight Wall (sold separately)

Shown in downward orientation on 10' Straight Wall (sold separately)

EUROFIT TAGALONG

Expand select EuroFit displays by attaching the EuroFit Tagalong to the top or side.

- Compatible with the top and sides of the EuroFit Straight Wall, Infinity and Gateway displays
- Compatible with the sides of the EuroFit Arc Wall, Incline Wall, and Cascade displays



EuroFit Tagalong

Item #	Description	1	2-5	6-11	12-24
256430	2'W Kit	76.50	74.20	71.90	69.60
256432	2'W Graphic Cover	43.70	42.40	41.10	39.80
256433	3'W Kit	125.10	121.60	117.20	113.70
256435	3'W Graphic Cover	76.00	74.00	71.00	69.00
256436	4'W Kit	159.00	154.00	149.00	145.00
256438	4'W Graphic Cover	99.00	96.00	93.00	90.00
256439	5'W Kit	179.00	174.00	168.00	163.00
256441	5'W Graphic Cover	109.00	106.00	102.00	99.00
256442	8'W Kit	226.00	220.00	212.00	206.00
256444	8'W Graphic Cover	143.00	139.00	134.00	130.00
256445	10'W Kit	289.00	281.00	271.00	263.00
256447	10'W Graphic Cover	180.00	175.00	169.00	164.00
Kit Includes: Hardware, Clamps, Graphic Cover and Soft Carry Case				USD MSRP (C)	

Description	Product Size	Finished Graphic Size	Product Wt.	Media
2'W	23.5"W x 16.25"H x 1.75"D	View Online Template	2.5 lbs.	Polyester Knit
3'W	35.25"W x 16.25"H x 1.75"D	View Online Template	3.25 lbs.	Polyester Knit
4'W	47"W x 16.25"H x 1.75"D	View Online Template	4 lbs.	Polyester Knit
5'W	59"W x 16.25"H x 1.75"D	View Online Template	4.75 lbs.	Polyester Knit
8'W	94.25"W x 16.25"H x 1.75"D	View Online Template	6.75 lbs.	Polyester Knit
10'W	118.25"W x 16.25"H x 1.75"D	View Online Template	7.75 lbs.	Polyester Knit



Attaches using clamps included in each kit.



Heavy-duty zipper secures the graphic cover.



3', 5' and 8' shown on 10' Straight Wall (sold separately)

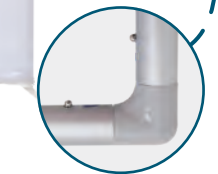

Push-button connectors make it easy to assemble.

Setup fee: \$20.00(G); no setup fee on orders placed via our website; see page 224 for details. View current graphic templates, assembly videos and instructions on our website. See pages 224-226 for additional information that may apply to your order.

AFTER FINAL PROOF APPROVAL
PRODUCTION LEAD TIME IS
4 DAYS



Shown with 4' Straight Wall (sold separately)



Sold in a set of two



Swivel caster wheels feature brakes so they can be locked into place.

EUROFIT WHEELED FEET

Add some wheels to your EuroFit Wall so it can be moved across the floor with ease.

- Display will be about 1/4" taller with wheels than with its standard feet



EuroFit Wheeled Feet

Patent Pending

Item #	Description	Product Wt.	1	2-5	6-11	12-24
255128	Wheeled Feet (2)	2.25 lbs.	50.00	48.50	47.00	45.50

USD MSRP (C)

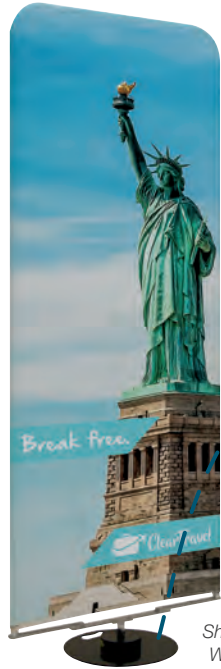

Shown with 3' Straight Wall (sold separately)

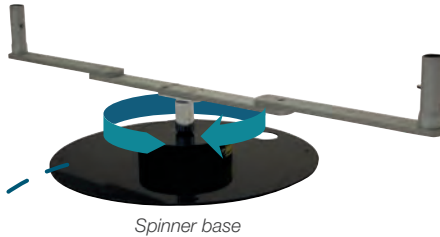

Spinner base

EUROFIT MOTORIZED SPINNER BASE

This base adds an eye-catching spin to your 2' or 3' EuroFit Wall.

- Sturdy steel base plate with high-gloss black enamel finish
- Smooth, quiet operation
- Six rotations per minute (RPM)
- Designed for indoor use only



EuroFit Motorized Spinner Base

Item #	Description	Product Wt.	1	2-5	6-11	12-24
254424	Spinner Base	16.2 lbs.	249.00	239.00	228.00	218.00

USD MSRP (C)



A handle cutout in the base makes it easy to move.



Threaded metal bracket twists onto the base.



Bracket adjusts for use with 2' or 3' EuroFit Walls.

Shown with Ultimate LED Light (sold separately)



EUROFIT LIGHT CLAMP

This clamp lets you add an Ultimate LED Light Kit to your EuroFit display.

- For use on horizontal tubing only
- Ultimate LED Light Kit sold separately; see page 217
- Lights cannot be used in conjunction with spinner base



EuroFit Light Clamp

Item #	Description	1	2-5	6-11	12-24
255125	Light Clamp	5.40	5.20	5.10	4.90

Clamp only. Ultimate LED Light Kit sold separately; see page 217. USD MSRP (C)

EUROFIT INFINITY

The EuroFit Infinity creates a fun three-dimensional display for infinite viewing angles.

- This display is approximately 10' wide
- Artwork is dye sublimated on polyester knit
- Graphic cover slips over the frame like a pillowcase, then zips shut
- Heavy-duty zipper keeps the graphic cover secure and taut
- Fabric contours to the frame for a form-fitted look



Infinity

EuroFit Infinity

Item #	Description	1	2-5	6-11	12-24
255236	Kit	1470.00	1440.00	1395.00	1370.00
255238	Graphic Cover	960.00	940.00	910.00	895.00
Kit Includes: Hardware, Graphic Cover, EuroFit Connector and Soft Carry Case				USD MSRP (C)	
Product Size	Finished Graphic Size	Product Wt.	Media		
118.5"W x 94.5"H x 16"D	View Online Template	33.5 lbs.	Polyester Knit		



The top and bottom of the display feature a slit so you can add weights (weights not included).



8' and 10' Vortex (not compatible with EuroFit Connector or other EuroFit accessories)

EUROFIT VORTEX

Add a creative twist to your event with the EuroFit Vortex.

- Artwork is dye sublimated on polyester knit
- Graphic cover slips over the frame like a pillowcase, then zips shut
- Heavy-duty zipper keeps the graphic cover secure and taut
- Fabric contours to the frame for a form-fitted look



EuroFit Vortex

Item #	Description	1	2-5	6-11	12-24
256415	8'H Kit	1470.00	1440.00	1400.00	1365.00
256417	8'H Graphic Cover	925.00	905.00	880.00	860.00
256418	10'H Kit	1690.00	1655.00	1610.00	1570.00
256420	10'H Graphic Cover	1040.00	1020.00	990.00	965.00
Kit Includes: Hardware, Graphic Cover and Soft Carry Case				USD MSRP (C)	
Description	Product Size	Finished Graphic Size	Product WL	Media	
8'H	86.75"W x 96"H x 86.75"D	View Online Template	26 lbs.	Polyester Knit	
10'H	87.75"W x 121"H x 87.75"D	View Online Template	30 lbs.	Polyester Knit	

Setup fee: \$20.00(G); no setup fee on orders placed via our website; see page 224 for details.
View current graphic templates, assembly videos and instructions on our website.
See pages 224-226 for additional information that may apply to your order.

AFTER FINAL PROOF APPROVAL
PRODUCTION LEAD TIME IS
4 DAYS



20' Arch (not compatible with EuroFit Connector or other EuroFit accessories)

10' Arch

EUROFIT ARCH

Use this versatile exhibit as an archway, or flip it horizontally to define a space.

- This display is more than 10' wide
- Artwork is dye sublimated on polyester knit
- Graphic cover slips over the frame like a pillowcase, then zips shut
- Heavy-duty zipper keeps the graphic cover secure and taut
- Fabric contours to the frame for a form-fitted look
- Hex wrench included



EuroFit Arch

Item #	Description	1	2-5	6-11	12-24
255155	10'W Kit	1520.00	1490.00	1445.00	1415.00
255157	10'W Graphic Cover	845.00	830.00	805.00	785.00
255160	20'W Kit	2145.00	2100.00	2040.00	1995.00
255162	20'W Graphic Cover	1245.00	1220.00	1185.00	1160.00

Kit Includes: Hardware, Graphic Cover, EuroFit Connector (10' Kit Only) and Soft Carry Case USD MSRP (C)

Description	Product Size	Finished Graphic Size	Product Wt.	Media
10'W	132"W x 103.75"H x 39.5"D	View Online Template	25 lbs.	Polyester Knit
20'W	252"W x 153"H x 39.5"D	View Online Template	54.8 lbs.	Polyester Knit

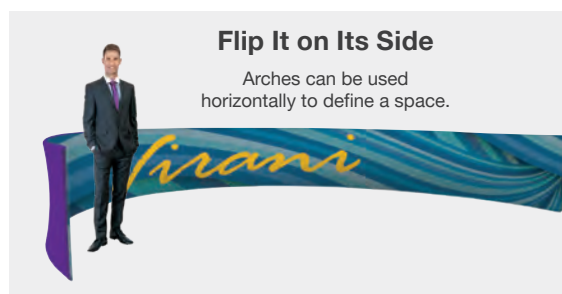

Flip It on Its Side

Arches can be used horizontally to define a space.

EUROFIT ARCH PLUS

Combine all the ad space of an eye-catching arch with an additional front panel for even more graphic coverage.

- Artwork is dye sublimated on polyester knit
- Graphic cover slips over the frame like a pillowcase, then zips shut
- Heavy-duty zipper keeps the graphic cover secure and taut
- Fabric contours to the frame for a form-fitted look
- Hex wrench included



EuroFit Arch Plus

Item #	Description	1	2-5	6-11	12-24
255163	10'W Kit	1600.00	1565.00	1520.00	1490.00
255164	10'W Graphic Cover	925.00	905.00	880.00	860.00
255165	20'W Kit	2215.00	2170.00	2105.00	2060.00
255166	20'W Graphic Cover	1315.00	1290.00	1250.00	1225.00

Kit Includes: Hardware, Graphic Cover, EuroFit Connector (10' Kit Only) and Soft Carry Case USD MSRP (C)

Description	Product Size	Finished Graphic Size	Product Wt.	Media
10'W	132"W x 103.75"H x 39.5"D	View Online Template	25.75 lbs.	Polyester Knit
20'W	252"W x 153"H x 39.5"D	View Online Template	56 lbs.	Polyester Knit



20' Arch Plus (not compatible with EuroFit Connector or other EuroFit accessories)

10' Arch Plus

AFTER FINAL PROOF APPROVAL
PRODUCTION LEAD TIME IS
7 DAYS

Setup fee: \$20.00(G); no setup fee on orders placed via our website; see page 224 for details.
View current graphic templates, assembly videos and instructions on our website.
See pages 224-226 for additional information that may apply to your order.

EUROFIT TRIUMPH WITH RUNNER

Make a grand entrance with this supersized display. The included runner lets you dedicate more space to your message.

- Artwork is dye sublimated on polyester knit
- Graphic cover slips over the frame like a pillowcase, then zips shut
- Heavy-duty zipper keeps the graphic cover secure and taut
- The runner includes aluminum dowels that slip inside its pole pockets to keep it weighed down



EuroFit Triumph with Runner

Item #	Description	1	2-5	6-11	12-24
256340	Kit	1735.00	1700.00	1650.00	1610.00
256342	Graphic Cover and Runner	1125.00	1100.00	1070.00	1045.00
Kit Includes: Hardware, Graphic Cover, Runner and Soft Carry Case		USD MSRP (C)			
Runner is printed single-sided.					

Product Size
142.5"W x 126.75"H x 48.25"D

Finished Graphic Size
View Online Template

Product Wt.
62.2 lbs.

Media
Polyester Knit

Head Clearance: 89.5"H



Triumph with runner (not compatible with EuroFit Connector or other EuroFit accessories)

EUROFIT GATEWAY

This double-sided display is lightweight and stylish. The Gateway shape offers a printable overhead surface without sacrificing headroom.

- Artwork is dye sublimated on polyester knit
- Graphic cover slips over the frame like a pillowcase, then zips shut
- Heavy-duty zipper keeps the graphic cover secure and taut
- Fabric contours to the frame for a form-fitted look



EuroFit Gateway

Item #	Description	1	2-5	6-11	12-24
256403	Kit	1530.00	1500.00	1455.00	1420.00
256405	Graphic Cover	985.00	965.00	935.00	915.00
Kit Includes: Hardware, Graphic Cover, EuroFit Connector and Soft Carry Case		USD MSRP (C)			

Product Size
96"W x 90.5"H x 39.5"D

Finished Graphic Size
View Online Template

Product Wt.
27.5 lbs.

Media
Polyester Knit



Gateway

EUROFIT CHALET

This overhead display creates an attractive space for promoting your brand or message.

- Recommended for indoor use
- Artwork is dye sublimated on polyester knit
- Heavy-duty zippers on both sides of the graphic cover for easy setup



EuroFit Chalet

Item #	Description	1	2-5	6-11	12-24
256490	Kit	1685.00	1650.00	1600.00	1565.00
256492	Graphic Cover	910.00	890.00	865.00	845.00
Kit Includes: Hardware, Graphic Cover and Soft Carry Case		USD MSRP (C)			

Product Size
129"W x 99.25"H x 126"D

Finished Graphic Size
View Online Template

Product Wt.
79 lbs.

Media
Polyester Knit



Fabric canopy contours to the frame's stylish curves to create a form-fitted look.



Joints are labeled for step-by-step frame assembly.



Chalet (not compatible with EuroFit Connector or other EuroFit accessories)

Setup fee: \$20.00(G); no setup fee on orders placed via our website; see page 224 for details.
View current graphic templates, assembly videos and instructions on our website.
See pages 224-226 for additional information that may apply to your order.

AFTER FINAL PROOF APPROVAL
PRODUCTION LEAD TIME IS
4 DAYS

EUROFIT EVOLUTION

Prepare to steal the show with this unique addition to the EuroFit family. Featuring an attractive incline and vibrantly dye-sublimated graphic, you'll understand why this line is famous.

- Artwork is dye sublimated on polyester knit
- Lightweight aluminum frame
- Display as a set or individually
- Graphic cover slips over the frame like a pillowcase
- Double-sided graphic cover is viewable from both the front and back of the display
- Tool-free frame assembly allows for quick and easy setup
- Not compatible with EuroFit Connector or other EuroFit accessories



Suggested Uses:
Retail Shops
Trade Shows
Demonstrations
Food Tastings



Fabric contours to the frame for a form-fitted look.



Secure apparel bar supports up to 25 lbs.



1.5' Incline

3' One-shelf Incline

4' Two-shelf Incline

2' Apparel Incline



Joints are labeled for step-by-step frame assembly.

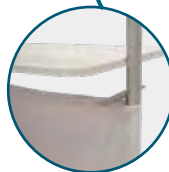

Shelves attach magnetically to the hardware and hold up to 20 lbs.

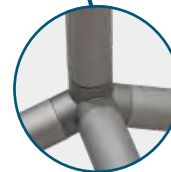

Base is assembled using the 4-prong connector.



EuroFit Evolution Incline

Item #	Description	1	2-5	6-11	12-24
258200	1.5'W Kit	245.00	238.00	230.00	223.00
258202	1.5'W Graphic Cover	100.00	97.00	94.00	91.00
258203	3'W Kit	315.00	306.00	296.00	287.00
258205	3'W Graphic Cover	140.00	136.00	132.00	127.00

Kit Includes: Hardware, Graphic Cover and Soft Carry Case USD MSRP (C)

Description	Product Size	Finished Graphic Size	Product Wt.	Media
1.5'W	16"W x 59.25"H x 15.25"D	View Online Template	5.4 lbs.	Polyester Knit
3'W	35.5"W x 71"H x 15.25"D	View Online Template	8.3 lbs.	Polyester Knit



EuroFit Evolution Apparel Incline

Item #	Description	1	2-5	6-11	12-24
258210	2"W Kit	345.00	335.00	324.00	314.00
258212	2"W Graphic Cover	130.00	126.00	122.00	118.00
258213	3'W Kit	415.00	405.00	393.00	383.00
258215	3'W Graphic Cover	140.00	136.00	132.00	127.00

Kit Includes: Hardware, Graphic Cover and Soft Carry Case USD MSRP (C)

Description	Product Size	Finished Graphic Size	Product Wt.	Media
2"W	23"W x 59.25"H x 15.25"D	View Online Template	5.4 lbs.	Polyester Knit
3'W	35.5"W x 71"H x 15.25"D	View Online Template	7.5 lbs.	Polyester Knit



EuroFit Evolution One-Shelf Incline

Item #	Description	1	2-5	6-11	12-24
258230	2'W Kit	450.00	439.00	426.00	415.00
258232	2'W Graphic Covers	175.00	170.00	165.00	159.00
258233	3'W Kit	550.00	537.00	520.00	508.00
258235	3'W Graphic Covers	200.00	194.00	188.00	182.00
258236	4'W Kit	650.00	637.00	618.00	605.00
258238	4'W Graphic Covers	300.00	295.00	285.00	280.00

Kit Includes: Hardware, 2 Graphic Covers and Soft Carry Case USD MSRP (C)

Description	Product Size	Finished Graphic Size	Product Wt.	Media
2'W	23.75"W x 59.25"H x 15.25"D	View Online Template	12 lbs.	Polyester Knit
3'W	35.5"W x 71"H x 15.25"D	View Online Template	16.3 lbs.	Polyester Knit
4'W	47.25"W x 71"H x 15.25"D	View Online Template	21.2 lbs.	Polyester Knit



EuroFit Evolution Two-Shelf Incline

Item #	Description	1	2-5	6-11	12-24
258240	2'W Kit	650.00	637.00	618.00	605.00
258242	2'W Graphic Covers	275.00	270.00	260.00	255.00
258243	3'W Kit	750.00	735.00	713.00	698.00
258245	3'W Graphic Covers	325.00	320.00	310.00	300.00
258246	4'W Kit	850.00	833.00	808.00	791.00
258248	4'W Graphic Covers	375.00	370.00	355.00	350.00

Kit Includes: Hardware, 3 Graphic Covers and Soft Carry Case USD MSRP (C)

Description	Product Size	Finished Graphic Size	Product Wt.	Media
2'W	23.75"W x 59.25"H x 15.25"D	View Online Template	16 lbs.	Polyester Knit
3'W	35.5"W x 71"H x 15.25"D	View Online Template	23 lbs.	Polyester Knit
4'W	47.25"W x 71"H x 15.25"D	View Online Template	32.2 lbs.	Polyester Knit

Setup fee: \$20.00(G); no setup fee on orders placed via our website; see page 224 for details.
View current graphic templates, assembly videos and instructions on our website.
See pages 224-226 for additional information that may apply to your order.

AFTER FINAL PROOF APPROVAL
PRODUCTION LEAD TIME IS
4 DAYS

FREESTANDING

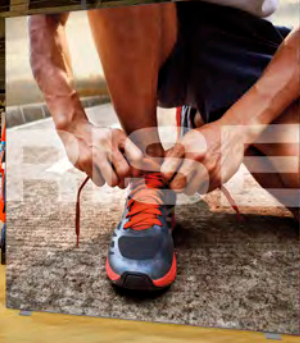

WALL-MOUNTED



SUSPENDED



CUSTOMIZE WITH XARISMA™ SILICONE EDGE GRAPHICS (SEG) Offering custom creations for every space and style

When designing an SEG display for your event or space
have you considered...



- **LONGEVITY** - Will the display be a temporary or a permanent fixture?
- **PRESENTATION** - Will your display be freestanding, wall-mounted, or suspended from the ceiling?
- **SIZE** - What are the desired dimensions of your display?
- **LOCATION** - Will the placement of your display require the frame to accommodate one or two graphic panels?
- **ILLUMINATION** - Will your display require internal lighting?

Choose Your Style



Freestanding

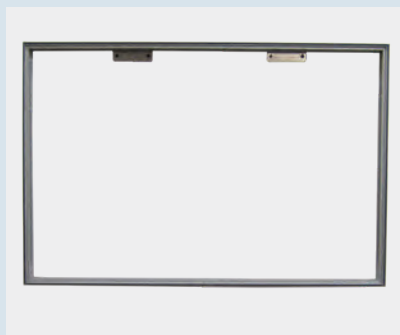

Wall-Mounted



Suspended

HOW IT WORKS

THE FRAME

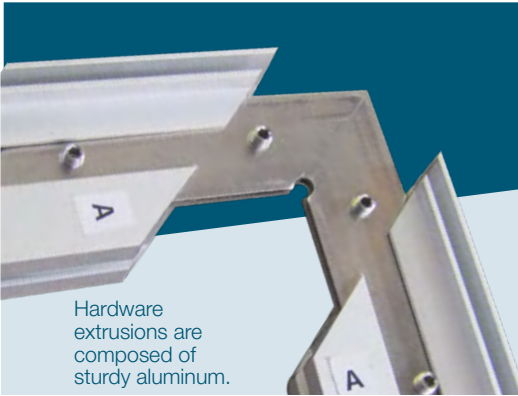

THE GRAPHICS

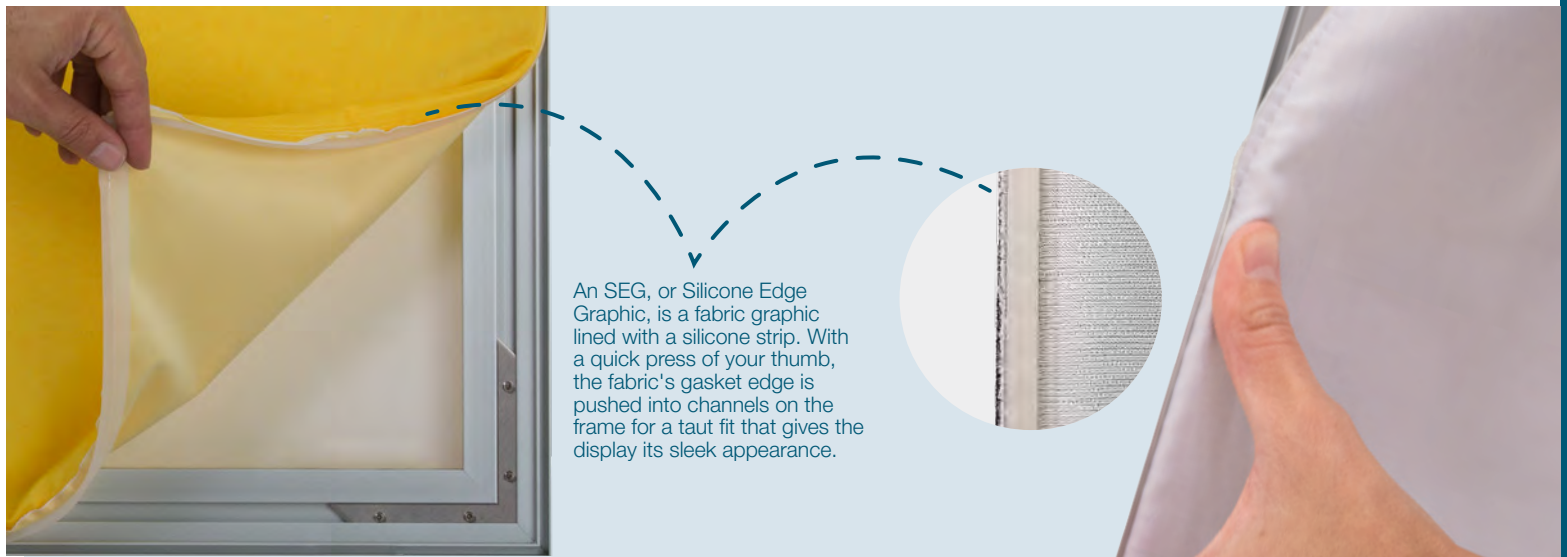

CHANGING YOUR MESSAGE



THE POSSIBILITIES ARE ENDLESS
IT'S EASY TO CUSTOMIZE WITH SHOWDOWN DISPLAYS!

Call for quote and lead time; size restrictions apply



LIGHTS UP!



FUSION GLO

This light-up display is incredibly simple to set up so you're ready when it's glow time.

- Artwork is dye sublimated on premium polyester
- Includes two graphic panels for a double-sided display
- Silicone Edge Graphics (SEG) for easy graphic panel installation



4' x 4' can also be used as a tabletop display.

Fusion Glo

Item #	Description	1	2-5	6-11	12-24
280420	4' x 4' Kit	875.00	840.00	805.00	761.00
254430	3' x 6.5' Kit	875.00	840.00	805.00	761.00

Kit Includes: Hardware and 2 Graphic Panels

USD MSRP (C)

Description	Product Size	Finished Graphic Size	Product Wt.	Media
4' x 4'	51.25"W x 51.75"H x 16"D	View Online Template	25.2 lbs.	Premium Polyester
3' x 6.5'	39.5"W x 79.25"H x 16"D	View Online Template	27.6 lbs.	Premium Polyester

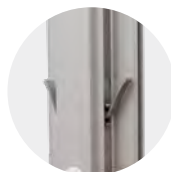

Lightweight aluminum frame has locking levers for a tool-free assembly.



With a quick press of your thumb, the fabric's gasket edge is pushed into narrow channels built into the frame.



LED lights on the top and bottom of the display create a soothing glow effect.

AFTER FINAL PROOF APPROVAL
PRODUCTION LEAD TIME IS
4 DAYS

Setup fee: \$20.00(G); no setup fee on orders placed via our website; see page 224 for details.
View current graphic templates, assembly videos and instructions on our website.
See pages 224-226 for additional information that may apply to your order.

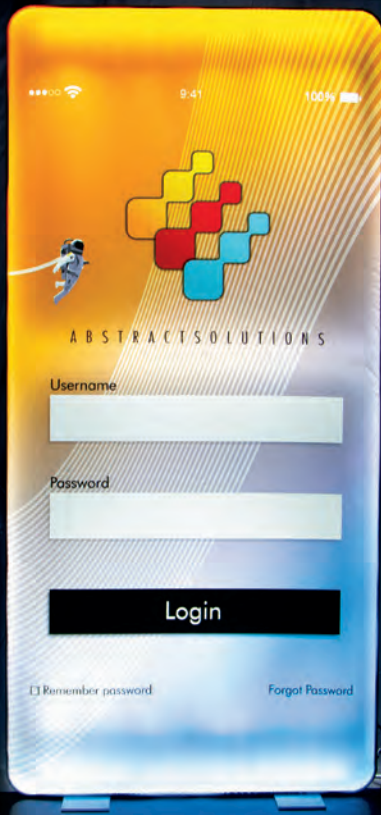

LIGHTS UP!

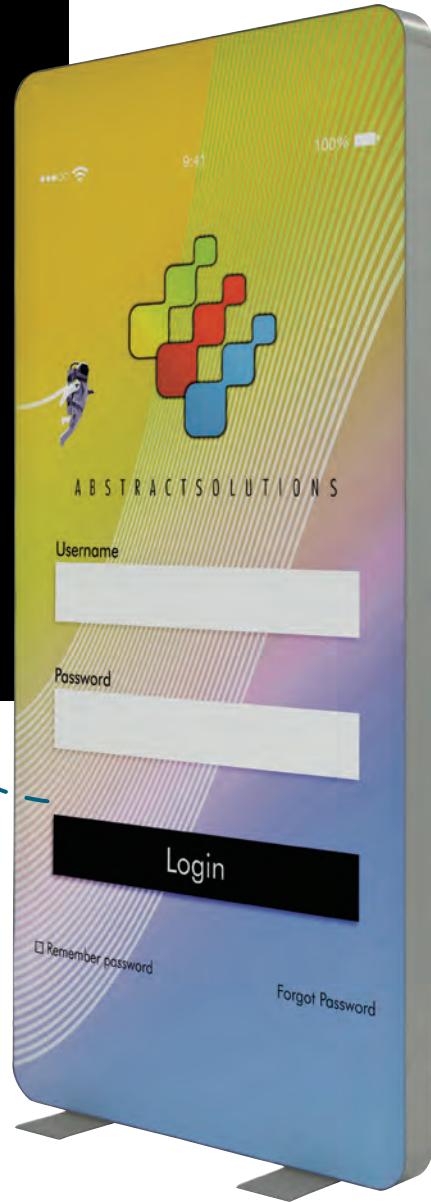

RADIUS GLO

This light-up display gets noticed everywhere it glows.

- The shape of the display matches that of a smartphone
- Artwork is dye sublimated on premium woven polyester
- Includes two graphic panels for a double-sided display
- Silicone Edge Graphics (SEG) for easy graphic panel installation
- Assembly tools included



Radius Glo

Item #	Description	1	2-5	6-11	12-24
254160	Kit	1326.00	1306.00	1255.00	1235.00

Kit Includes: Hardware, 2 Graphic Panels and Soft Carry Case USD MSRP (C)

Product Size	Finished Graphic Size	Product Wt.	Media
37.5"W x 79"H x 13.75"D	View Online Template	32.6 lbs.	Premium Woven Polyester



With a quick press of your thumb, the fabric's gasket edge is pushed into narrow channels built into the frame.



LED lights on the top and bottom of the display create a soothing glow effect.

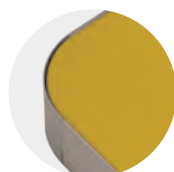

Lightweight aluminum frame features rounded plastic corners.

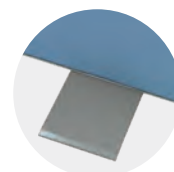

Two rectangular feet for an elegant, stable footprint.

Setup fee: \$20.00(G); no setup fee on orders placed via our website; see page 224 for details. View current graphic templates, assembly videos and instructions on our website. See pages 224-226 for additional information that may apply to your order.

AFTER FINAL PROOF APPROVAL
PRODUCTION LEAD TIME IS
4 DAYS



LIGHTS UP!



LITFIT WALL

This illuminated display is incredibly simple to set up, so you can light up your message with ease.

- Artwork is dye sublimated on premium woven polyester
- Lights are optimized for single-sided display
- Not compatible with EuroFit Connector or other EuroFit accessories



LitFit Wall

Item #	Description	1	2-5	6-11	12-24
256503	Kit	920.00	900.00	875.00	860.00

Kit Includes: Hardware, Graphic Cover and Soft Carry Case USD MSRP (C)

Product Size	Finished Graphic Size	Product Wt.	Media
37.75"W x 91"H x 19"D	View Online Template	20.6 lbs.	Premium Woven Polyester



Graphic cover slips over the frame like a pillowcase.



1.75" aluminum frame features push-button connectors for easy setup.

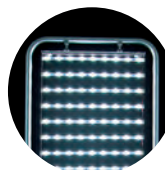

Bright LED lights create a pleasant glow.



The included LED ladder light attaches to the frame using plastic hooks.

4 DAYS
AFTER FINAL PROOF APPROVAL
PRODUCTION LEAD TIME IS

Setup fee: \$20.00(G); no setup fee on orders placed via our website; see page 224 for details.
View current graphic templates, assembly videos and instructions on our website.
See pages 224-226 for additional information that may apply to your order.

TRAVERSE DISPLAY

Perfect for on-the-go marketers, this cost-conscious fabric display features a unique center hub system that allows it to collapse into one piece.

- Corner pockets on the back of the banner slip over the ends of the pole to keep the fabric taut
- Artwork is dye sublimated on polyester knit
- 1" anodized aluminum frame
- Shock cord poles make setup and tear-down easy



Traverse Display

Item #	Description	1	2-5	6-11	12-24
254240	8' Kit	690.00	670.00	645.00	625.00
254243	10' Kit	805.00	785.00	760.00	740.00

Kit Includes: Frame, Banner and Soft Carry Case USD MSRP (C)

Description	Product Size	Finished Graphic Size	Product Wt.	Media
8'	94.5"W x 71.5"H x 20"D	View Online Template	9.3 lbs.	Polyester Knit
10'	119"W x 89"H x 26"D	View Online Template	11.5 lbs.	Polyester Knit

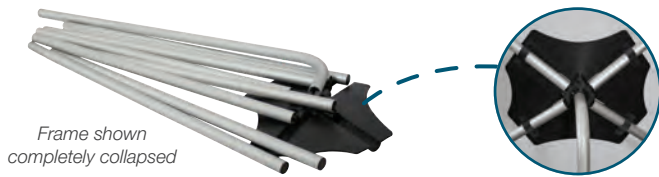

Frame shown completely collapsed

Unique center hub system allows frame to collapse into one piece.



PIPE & DRAPE BANNER AND HEADER

These banners and headers can be hung from any standard trade show pipe and drape to make your booth stand out.

- Artwork is dye sublimated on Titan™ no-curl fabric
- S-hooks included
- Pipe and drape not included



Pipe & Drape Banner

Item #	Description	Product Wt.	1	2-5	6-11	12-24
253100	18"W x 48"H Banner Kit	0.36 lb.	58.00	56.00	55.00	53.00
253101	24"W x 60"H Banner Kit	0.5 lb.	72.00	70.00	68.00	66.00
253102	24"W x 72"H Banner Kit	0.6 lb.	87.00	84.00	82.00	79.00
253103	36"W x 96"H Banner Kit	1.2 lbs.	150.00	146.00	141.00	137.00
253115	120"W x 96"H Banner Kit	4 lbs.	454.00	440.00	427.00	413.00

Kit Includes: Banner and S-Hooks USD MSRP (C)

Pipe & Drape Header

Item #	Description	Product Wt.	1	2-5	6-11	12-24
253105	72"W x 18"H Header Kit	0.45 lb.	87.00	84.00	82.00	79.00
253106	96"W x 12"H Header Kit	0.4 lb.	87.00	84.00	82.00	79.00
253107	96"W x 18"H Header Kit	0.6 lb.	114.00	111.00	107.00	104.00
253108	120"W x 24"H Header Kit	1 lb.	143.00	139.00	134.00	130.00

Kit Includes: Header and S-Hooks USD MSRP (C)



Banner is finished with clear plastic grommets that connect to the included S-hooks.



120"W x 24"H Header Kit shown on standard trade show pipe and drape (not included)

120"W x 96"H Banner Kit shown on standard trade show pipe and drape (not included)

Setup fee: \$20.00(G); no setup fee on orders placed via our website; see page 224 for details. View current graphic templates, assembly videos and instructions on our website. See pages 224-226 for additional information that may apply to your order.

AFTER FINAL PROOF APPROVAL
PRODUCTION LEAD TIME IS
4 DAYS

Suggested Uses:
Media Backdrops
Aquariums
Product Intros
Lobbies



DELUXE EXHIBITOR EXPANDING DISPLAY

This display features an adjustable frame so it can showcase a variety of banner sizes.

- Vertical and horizontal telescoping poles accommodate various banner sizes
- Artwork is dye sublimated on polyester knit
- 3" pole pockets on the top and bottom of the banner keep it in place
- Screwdriver included
- Custom banner sizes available (call for quote; restrictions may apply)



Deluxe Exhibitor Expanding Display

Item #	Description	1	2-5	6-11	12-24
254140	6' Kit	550.00	535.00	515.00	500.00
254143	6' Banner Only	214.00	208.00	201.00	195.00
254141	7.5' Kit	655.00	635.00	615.00	595.00
254144	7.5' Banner Only	268.00	260.00	252.00	244.00
254142	10' Kit	775.00	750.00	730.00	705.00
254145	10' Banner Only	327.00	317.00	307.00	298.00

Kit Includes: Hardware, Banner and Soft Carry Case

USD MSRP (C)

Description	Product Size	Finished Graphic Size	Product Wt.	Media
6'	69"W x 98"H x 16.5"D	63"W x 95"H	18.25 lbs.	Polyester Knit
7.5'	84"W x 98"H x 16.5"D	78"W x 95"H	19 lbs.	Polyester Knit
10'	117"W x 98"H x 16.5"D	111"W x 95"H	20 lbs.	Polyester Knit

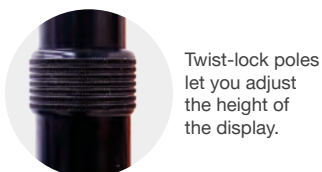

Setup fee: \$20.00(G); no setup fee on orders placed via our website; see page 224 for details.
View current graphic templates, assembly videos and instructions on our website.
See pages 224-226 for additional information that may apply to your order.

AFTER FINAL PROOF APPROVAL
PRODUCTION LEAD TIME IS
2 DAYS



BRAVO EXPANDING DISPLAY

The Bravo is the most durable and dependable expanding display available.

- Double-sided banner options now available
- Frame poles are adjustable to accommodate a variety of banner sizes
- Reinforced joints keep the banner taut over an extended period of time
- Single-sided graphics are dye sublimated on polyester knit
- Double-sided graphics available on block-out fabric
- Small feet for a discreet footprint
- Custom banner sizes available (call for quote; restrictions may apply)



NEW
DOUBLE-SIDED
OPTION

Bravo Expanding Display

Item #	Description	1	2-5	6-11	12-24
254150	8' Single-Sided Kit	620.00	595.00	575.00	550.00
254154	8' Single-Sided Banner Only	300.00	291.00	282.00	273.00
254156	8' Double-Sided Kit	860.00	840.00	817.00	797.00
254157	8' Double-Sided Banner Only	385.00	375.00	365.00	360.00
254151	10' Single-Sided Kit	750.00	725.00	705.00	680.00
254155	10' Single-Sided Banner Only	364.00	353.00	342.00	331.00
254158	10' Double-Sided Kit	940.00	919.00	893.00	872.00
254159	10' Double-Sided Banner Only	465.00	455.00	440.00	430.00

Kit Includes: Hardware, Banner and Soft Carry Case

USD MSRP (C)

Description	Product Size	Finished Graphic Size	Product Wt.	Media (Single-Sided/Double-Sided)
8'	94"W x 94.25"H x 14"D	89"W x 93"H	20.2 lbs.	Polyester Knit / Block-Out Fabric
10'	118"W x 94.25"H x 14"D	113"W x 93"H	22 lbs.	Polyester Knit / Block-Out Fabric



Setup fee: \$20.00(G); no setup fee on orders placed via our website; see page 224 for details.
View current graphic templates, assembly videos and instructions on our website.
See pages 224-226 for additional information that may apply to your order.







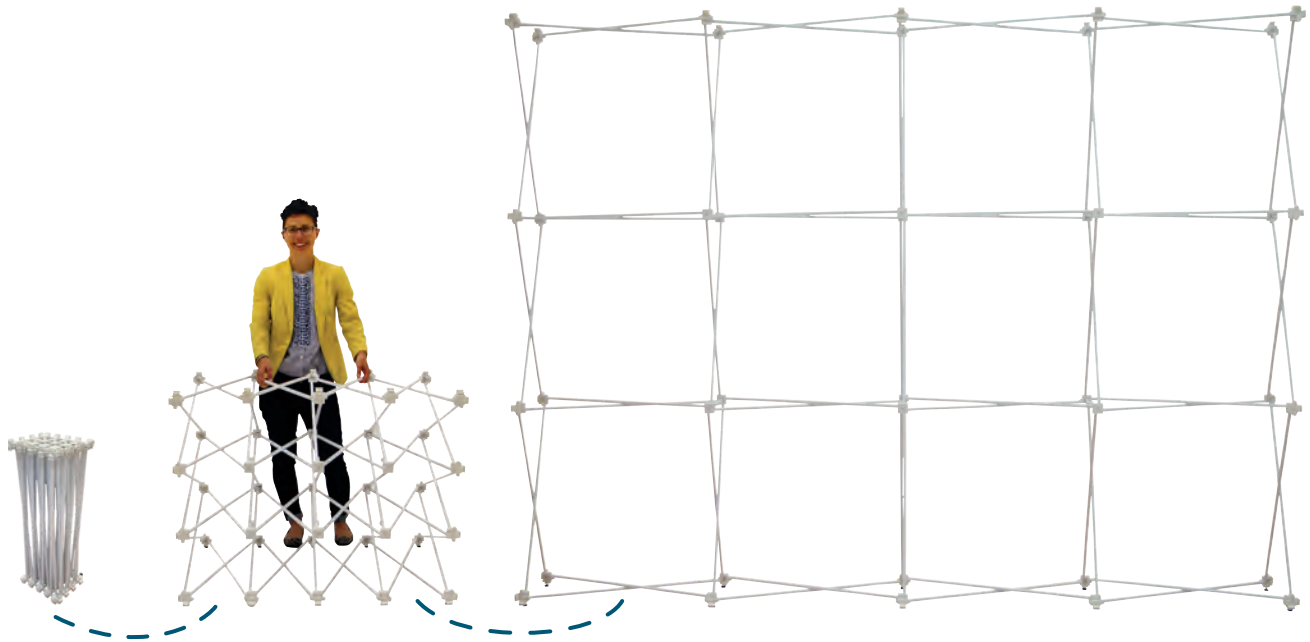











AFTER FINAL PROOF APPROVAL
PRODUCTION LEAD TIME IS
2 DAYS

POP-UP DISPLAYS

WHICH POP-UP IS RIGHT FOR YOU?



POP-UP COMPARISON CHART

		PG	EASE OF SETUP	FRAME WARRANTY	FRAME DURABILITY	PANEL INSTALLATION	PANEL MATERIAL	ADD-ONS
FABRIC	Splash	188	★★★★	2 Years	 High-grade 0.03" aluminum frame with scissor construction and bayonet locking system. Medium-weight nylon connecting hubs.	 Graphic panels install using hook-and-loop fasteners.	Polyester Knit Block-Out Fabric	Ultimate LED Light Kits sold separately (see page 217)
SEG	Verge	190	★★★★	2 Years	 High-grade 0.038" aluminum frame with scissor construction and bayonet locking system; gloss painted for maximum light reflection. Square extrusions provide an easy interface to install lights.	 Pegs on the channel bars press into the frame's hubs to hold SEG panels in place.	Polyester Knit	Ultimate LED Light Kits sold separately (see page 217)
	Verge Glo	191	★★★★	2 Years	 High-grade 0.038" aluminum frame with scissor construction and bayonet locking system; gloss painted for maximum light reflection. Square extrusions provide an easy interface to install lights.	 Pegs on the channel bars press into the frame's hubs to hold SEG panels in place.	Premium Woven Polyester	Ultimate LED Light Kits sold separately (see page 217)
MULTI-PANEL	GeoMetrix	192	★★★★★	1 Year	 Lightweight 0.03" aluminum spring-action pop-up frame.	 Reinforced buttonholes on graphic panels attach to pegs on the frame's hubs.	Polyester Double Knit	Ultimate LED Light Kits sold separately (see page 217)
	Deluxe GeoMetrix	194	★★★★	2 Years	 High-grade 0.03" aluminum frame with scissor construction and bayonet locking system. Medium-weight nylon connecting hubs. Rectangular extrusions provide stability and strength for shelves.	 Reinforced buttonholes on graphic panels attach to pegs on the frame's hubs.	Polyester Double Knit	Ultimate LED Light Kits sold separately (see page 217) Internal Shelf (see page 194) Stabilizer Feet (see page 194) Connector Shelf (see page 197) End Panel Graphic Panels (see page 198)
	Deluxe GeoMetrix Connector	196	★★	2 Years	 High-grade 0.03" aluminum frame with scissor construction and bayonet locking system. Medium-weight nylon connecting hubs. Rectangular extrusions provide stability and strength for shelves.	 Reinforced buttonholes on graphic panels attach to pegs on the frame's hubs.	Polyester Double Knit	Ultimate LED Light Kits sold separately (see page 217) Internal Shelf (see page 194) Stabilizer Feet (see page 194) Connector Shelf (see page 197) End Panel Graphic Panels (see page 198)
MURAL PANEL	Echo	199	★★	1 Year	 Lightweight 0.03" aluminum spring-action pop-up frame.	 Individual locking channel bars for magnet-to-steel panel registration.	Fabric Panels Mural Panels	Case-to-Counter Conversion Kit included Ultimate LED Light Kits included with select kits
	Show 'N Rise	200	★★★★	2 Years	 High-grade 0.03" aluminum frame with scissor construction and bayonet locking system. Medium-weight nylon connecting hubs. Rectangular extrusions provide stability and strength for shelves.	 Shock cord magnet rails for magnet-to-magnet panel registration.	Fabric Panels Mural Panels	Case-to-Counter Conversion Kit included Ultimate LED Light Kits included Internal Shelf sold separately (see page 201)
	ARISE	202	★★★★★	Lifetime	 High-grade 0.04" extruded aluminum frame with self-locking scissor construction. Medium-weight nylon connecting hubs.	 Magnets connect bars to the frame for magnet-to-magnet panel registration.	Fabric Panels Mural Panels	Case-to-Counter Conversion Kit included Ultimate LED Light Kits included Internal Shelves sold separately (see page 203) External Shelves sold separately (see page 203)

PANEL MATERIAL

SPLASH POP-UP DISPLAYS



Wrap graphic panel

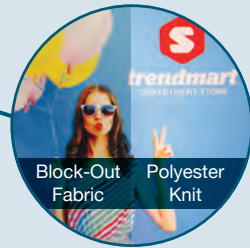

Block-Out Fabric Polyester Knit

BLOCK-OUT FABRIC
Block-out fabric keeps light from shining through your display for perfect photoshoots in well-lit areas.

POLYESTER KNIT
Dye sublimation on polyester knit produces vibrant, rich colors.



Face graphic panel

SEG POP-UP DISPLAYS



Verge

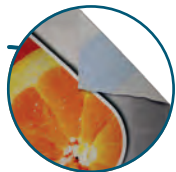

POLYESTER KNIT
Dye sublimation on polyester knit produces vibrant, rich colors.

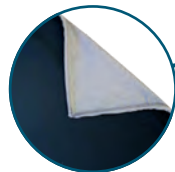

PREMIUM WOVEN POLYESTER
An ideal choice for backlit displays, premium woven polyester allows light to shine through.



Verge Glo

GEOMETRIX POP-UP DISPLAYS



Deluxe GeoMetrix Narrow Corner Connector



GeoMetrix Tower



Deluxe GeoMetrix Pyramid

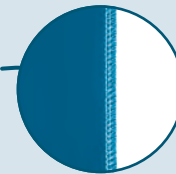

POLYESTER DOUBLE KNIT
Stretches both ways to create a taut fit on GeoMetrix frames, giving you countless options for setting up a creative display.

TRADITIONAL POP-UP DISPLAYS

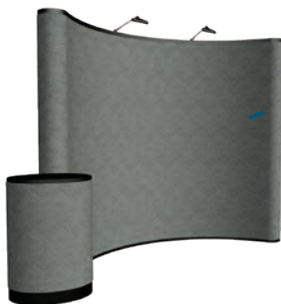

Full fabric panels

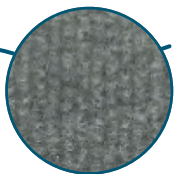

HOOK-AND-LOOP-RECEPTIVE FABRIC
High-quality polyester fiber.



Laminated center mural panels with fabric end panels

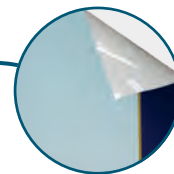

MURAL PANEL
Titan™ no-curl laminated media is rigid so it will not wrinkle or curl.



Laminated full mural panels

SPLASH DISPLAY

This pop-up display transforms from a compact unit to an impressive backdrop in minutes.

- Graphic panels available in polyester knit or block-out fabric; excludes 10' Tall Splash
- Hook-and-loop fasteners make graphic panel installation simple
- Aluminum frame with nylon plastic hubs
- 10' H option now available
- Tabletop version also available (see page 156)
- US Patent #9214104



Suggested Uses:

- Trade Shows
- Presentations
- Media Events
- Conferences



Kit Options



Face Graphic Kit
Graphic panel covers the front of the frame.



Wrap Graphic Kit
Graphic panel covers the front and two sides of the frame. Back of the frame is not covered.



4-Sided Graphic Kit
Graphic panel wraps all the way around the frame, covering the front, back and two sides.



20' straight is two frames with a single wrap graphic panel

8' Curved Splash

Item #	Description	Product Wt.	1	2-5	6-11	12-24
341020	8' Polyester Knit Face Kit	18.75 lbs.	975.00	955.00	935.00	920.00
342218	8' Block-Out Fabric Face Kit	19.5 lbs.	1055.00	1035.00	1015.00	995.00
341021	8' Polyester Knit Wrap Kit	19.75 lbs.	1170.00	1150.00	1130.00	1115.00
342219	8' Block-Out Fabric Wrap Kit	20.25 lbs.	1250.00	1230.00	1210.00	1190.00

Kit Includes: Frame, Graphic Panel and Soft Carry Case USD MSRP (C)

Product Size 93"W x 89.5"H x 24"D
Finished Graphic Size View Online Template

3' Straight Splash

Item #	Description	Product Wt.	1	2-5	6-11	12-24
341040	3' Polyester Knit Face Kit	9.4 lbs.	395.00	380.00	365.00	350.00
342200	3' Block-Out Fabric Face Kit	9.5 lbs.	485.00	470.00	455.00	440.00
341041	3' Polyester Knit Wrap Kit	10.25 lbs.	475.00	460.00	445.00	430.00
342201	3' Block-Out Fabric Wrap Kit	10.25 lbs.	560.00	540.00	520.00	500.00
341042	3' Polyester Knit 4-Sided Kit	11.5 lbs.	755.00	730.00	710.00	685.00

Kit Includes: Frame, Graphic Panel and Soft Carry Case USD MSRP (C)

Product Size 31"W x 89.5"H x 12.25"D
Finished Graphic Size View Online Template

8' Straight Splash

Item #	Description	Product Wt.	1	2-5	6-11	12-24
341004	8' Polyester Knit Face Kit	19.25 lbs.	975.00	955.00	935.00	920.00
342208	8' Block-Out Fabric Face Kit	20 lbs.	1055.00	1035.00	1015.00	995.00
341005	8' Polyester Knit Wrap Kit	20 lbs.	1170.00	1150.00	1130.00	1115.00
342209	8' Block-Out Fabric Wrap Kit	20.8 lbs.	1250.00	1230.00	1210.00	1190.00
341052	8' Polyester Knit 4-Sided Kit	24.25 lbs.	1800.00	1730.00	1660.00	1585.00

Kit Includes: Frame, Graphic Panel and Soft Carry Case USD MSRP (C)

Product Size 90"W x 89.5"H x 12.25"D
Finished Graphic Size View Online Template

20' Straight Splash

Item #	Description	Product Wt.	1	2-5	6-11	12-24
341029	20' Polyester Knit Wrap Kit	47.75 lbs.	2155.00	2125.00	2095.00	2065.00
342216	20' Block-Out Fabric Wrap Kit	49 lbs.	2215.00	2185.00	2155.00	2125.00

Kit Includes: 2 Frames, Graphic Panel and 2 Soft Carry Cases USD MSRP (C)

Product Size 237"W x 89.5"H x 12.25"D
Finished Graphic Size View Online Template



48-Hour Quick Ship Straight Splash

Item #	Description	1
250100	8' Polyester Knit Wrap Kit	1350.36
250101	10' Polyester Knit Wrap Kit	1544.63

USD MSRP (C)

Order must be placed via our website.
See page 226 for complete Quick Ship program requirements and ordering information.

10' Curved Splash

Item #	Description	Product Wt.	1	2-5	6-11	12-24
341024	10' Polyester Knit Face Kit	23.6 lbs.	1170.00	1150.00	1130.00	1115.00
342222	10' Block-Out Fabric Face Kit	24.25 lbs.	1250.00	1230.00	1210.00	1190.00
341025	10' Polyester Knit Wrap Kit	24.5 lbs.	1365.00	1345.00	1325.00	1310.00
342223	10' Block-Out Fabric Wrap Kit	25.75 lbs.	1440.00	1420.00	1400.00	1380.00

Kit Includes: Frame, Graphic Panel and Soft Carry Case USD MSRP (C)

Product Size 117.25"W x 89.5"H x 34"D
Finished Graphic Size View Online Template

5' Straight Splash

Item #	Description	Product Wt.	1	2-5	6-11	12-24
341046	5' Polyester Knit Face Kit	10.5 lbs.	690.00	665.00	640.00	620.00
342204	5' Block-Out Fabric Face Kit	16 lbs.	775.00	750.00	720.00	695.00
341047	5' Polyester Knit Wrap Kit	16.4 lbs.	850.00	825.00	805.00	780.00
342205	5' Block-Out Fabric Wrap Kit	16.5 lbs.	935.00	910.00	885.00	855.00
341048	5' Polyester Knit 4-Sided Kit	18.75 lbs.	1330.00	1280.00	1235.00	1185.00

Kit Includes: Frame, Graphic Panel and Soft Carry Case USD MSRP (C)

Product Size 61"W x 89.5"H x 12.25"D
Finished Graphic Size View Online Template

10' Straight Splash

Item #	Description	Product Wt.	1	2-5	6-11	12-24
341008	10' Polyester Knit Face Kit	23.75 lbs.	1170.00	1150.00	1130.00	1115.00
342212	10' Block-Out Fabric Face Kit	24.5 lbs.	1250.00	1230.00	1210.00	1190.00
341009	10' Polyester Knit Wrap Kit	24.75 lbs.	1365.00	1345.00	1325.00	1310.00
342213	10' Block-Out Fabric Wrap Kit	26 lbs.	1440.00	1420.00	1400.00	1380.00
341053	10' Polyester Knit 4-Sided Kit	31 lbs.	2085.00	1990.00	1895.00	1800.00

Kit Includes: Frame, Graphic Panel and Soft Carry Case USD MSRP (C)

Product Size 119"W x 89.5"H x 12.25"D
Finished Graphic Size View Online Template



10' Tall Straight Splash

Item #	Description	Product Wt.	1	2-5	6-11	12-24
341030	10'H Polyester Knit Face Kit	30.5 lbs.	1434.00	1385.00	1328.00	1279.00
341031	10'H Polyester Knit Wrap Kit	31.5 lbs.	1586.00	1529.00	1465.00	1408.00

Kit Includes: Frame, Graphic Panel and Soft Carry Case USD MSRP (C)

Product Size 119"W x 118.25"H x 12.25"D
Finished Graphic Size View Online Template

Block-Out Fabric

Block-out fabric is designed to prevent light from showing through the display. It is a good option for brightly lit areas.



Setup fee: \$20.00(G); no setup fee on orders placed via our website; see page 224 for details.
View current graphic templates, assembly videos and instructions on our website.
See pages 224-226 for additional information that may apply to your order.

AFTER FINAL PROOF APPROVAL
PRODUCTION LEAD TIME IS
3 DAYS



Channel bars slide into grooves in the hubs.



With a quick press of your thumb, the fabric's gasket edge is pushed into the channel bars.



8'

Graphic panels cover three sides of the display.

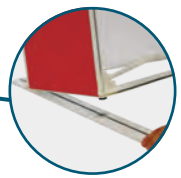

Thumbscrews on the bottom of the frame slip into a notch on the foot.



8' back view



A fourth graphic panel (sold separately) can be added to the back, no extra channel bars required.

VERGE DISPLAY

This display's modern design and crisp edges give your message an elegant, upscale look.

- Artwork is dye sublimated on polyester knit
- Silicone edge graphics (SEG) for easy graphic panel installation
- Heavy-duty aluminum frame pops open like a standard pop-up display
- Tabletop version also available (see page 157)



Verge Display

Item #	Description	1	2-5	6-11	12-24
254550	8' Kit	1375.00	1350.00	1305.00	1275.00
254555	10' Kit	1580.00	1550.00	1500.00	1470.00

Kit Includes: Frame, 3 Graphic Panels and Soft Carry Case with Wheels USD MSRP (C)

Description	Product Size	Finished Graphic Size	Product Wt.	Media
8'	88.75"W x 89.5"H x 23.25"D	View Online Template	34 lbs.	Polyester Knit
10'	117.75"W x 89.5"H x 23.25"D	View Online Template	39.5 lbs.	Polyester Knit

AFTER FINAL PROOF APPROVAL
PRODUCTION LEAD TIME IS
4 DAYS

Setup fee: \$20.00(G); no setup fee on orders placed via our website; see page 224 for details.
View current graphic templates, assembly videos and instructions on our website.
See pages 224-226 for additional information that may apply to your order.



LIGHTS UP!

VERGE GLO DISPLAY

The illuminated version of the Verge adds LED lights to the display's cutting-edge look.

- Artwork is dye sublimated on premium woven polyester
- Silicone edge graphics (SEG) for easy graphic panel installation
- Heavy-duty aluminum frame pops open like a standard pop-up display
- Thumbscrews on the bottom of the frame slip into a notch on the foot
- Graphic panels cover three sides of the display
- A fourth graphic panel (sold separately) can be added to the back, no extra channel bars required
- Tabletop version also available (see page 157)



Verge Glo Display

Item #	Description	1	2-5	6-11	12-24
254551	8' Kit	2290.00	2250.00	2175.00	2125.00
254556	10' Kit	2955.00	2900.00	2805.00	2750.00

Kit Includes: Frame, Ladder Lights, 3 Graphic Panels and Soft Carry Case with Wheels USD MSRP (C)

Description	Product Size	Finished Graphic Size	Product Wt.	Media
8'	88.75"W x 89.5"H x 23.25"D	View Online Template	69.5 lbs.	Premium Woven Polyester
10'	117.75"W x 89.5"H x 23.25"D	View Online Template	87 lbs.	Premium Woven Polyester

Each column of ladder lights can be lit separately and has its own power cord.



Channel bars slide into grooves in the hubs.



With a quick press of your thumb, the fabric's gasket edge is pushed into the channel bars.

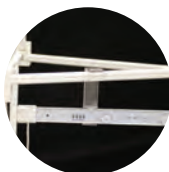

The included LED ladder lights attach to the inside of the display using plastic hooks.



LED ladder lights can be daisy-chained together vertically to create columns.

Setup fee: \$20.00(G); no setup fee on orders placed via our website; see page 224 for details. View current graphic templates, assembly videos and instructions on our website. See pages 224-226 for additional information that may apply to your order.

AFTER FINAL PROOF APPROVAL
PRODUCTION LEAD TIME IS
4 DAYS

GEOMETRIX DISPLAY

These displays support a multitude of graphic configurations so you can show off your presentation in a unique way.

- 50% lighter than a standard pop-up display
- Artwork is dye sublimated on polyester double knit
- Tabletop versions also available (see page 154)
- Additional kits and graphic panel kits available online



Centerpoint

3-Quad Tower

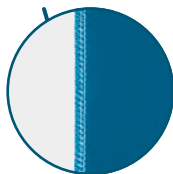

Graphic panels are finished with white stitching.

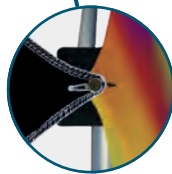

GeoMetrix pegs hold up to three panels each.



GeoMetrix Centerpoint Kit

Item #	Description	1	2-5	6-11	12-24
337121	Kit	1360.00	1330.00	1300.00	1270.00
Kit Includes: Twelve-Quad Frame, 10 Graphic Panels and Soft Carry Case				USD MSRP (C)	
Product Size	Finished Graphic Size	Product Wt.	Media		
119.38"W x 90.5"H x 11"D	View Online Template	23 lbs.	Polyester Double Knit		

GeoMetrix Classic Kit

Item #	Description	1	2-5	6-11	12-24
337122	Kit	1115.00	1085.00	1055.00	1025.00
Kit Includes: Nine-Quad Square Frame, 9 Graphic Panels and Soft Carry Case				USD MSRP (C)	
Product Size	Finished Graphic Size	Product Wt.	Media		
90.5"W x 90.5"H x 11"D	View Online Template	18 lbs.	Polyester Double Knit		



GeoMetrix 3-Quad Tower Kit

Item #	Description	1	2-5	6-11	12-24
337126	Kit	430.00	420.00	405.00	395.00
Kit Includes: Three-Quad Tower Frame, 3 Graphic Panels and Soft Carry Case				USD MSRP (C)	
Product Size	Finished Graphic Size	Product Wt.	Media		
31.5"W x 90.5"H x 11"D	View Online Template	7.25 lbs.	Polyester Double Knit		



GeoMetrix Checkerboard Kit

Item #	Description	1	2-5	6-11	12-24
337127	Kit	1115.00	1085.00	1055.00	1025.00
Kit Includes: Nine-Quad Square Frame, 9 Graphic Panels and Soft Carry Case				USD MSRP (C)	
Product Size	Finished Graphic Size	Product Wt.	Media		
90.5"W x 90.5"H x 11"D	View Online Template	18 lbs.	Polyester Double Knit		

Graphic Panels

Graphic panel kits are available online, or you can order graphic panels separately to create your own display; see page 198.



Add-Ons



Ultimate LED Double Light Kit
Item #150121
See Page 217



6' UltraFit Classic Throw
Item #114002
See Page 14

Setup fee: \$20.00(G); no setup fee on orders placed via our website; see page 224 for details.
View current graphic templates, assembly videos and instructions on our website.
See pages 224-226 for additional information that may apply to your order.

AFTER FINAL PROOF APPROVAL
PRODUCTION LEAD TIME IS
4 DAYS

DELUXE GEOMETRIX DISPLAY

A strong, durable frame supports multiple graphic panels and shelves so you have countless options for setting up a creative display.

- Setup and teardown can be done in seconds
- Artwork is dye sublimated on polyester double knit
- Aluminum frame with nylon plastic hubs
- Additional kits and graphic panel kits are available online
- US Patent #9214104



12-Quad Classic

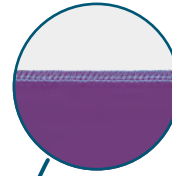

Graphic panels are finished with white stitching.



Shelf has rounded corners and supports up to 15 lbs.



Deluxe GeoMetrix pegs hold up to six panels each.



Feet slide into frame's hubs to keep the display stable when showcasing merchandise. Feet are not compatible with edge graphic panels.

Add-Ons

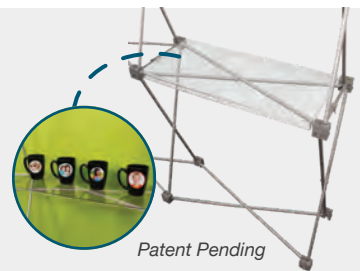

Patent Pending

Deluxe GeoMetrix Stabilizer Feet

Patent #9214104

Item #	Description	1	2-5	6-11	12-24
342070	Set of 4 for Three-Quad Tower Frame	21.40	20.80	20.10	19.50
342072	Set of 8 for Nine-Quad Square Frame	42.80	41.50	40.20	38.90
342073	Set of 10 for Twelve-Quad Frame	53.60	52.00	50.40	48.80

USD MSRP (C)

Deluxe GeoMetrix Internal Shelves

Item #	Description	1	2-5	6-11	12-24
338050	Internal Shelf	111.00	109.00	106.00	102.00
338068	Clear Internal Shelf	118.00	114.00	111.00	107.00

USD MSRP (C)

Internal shelves support up to 15 lbs.



Deluxe GeoMetrix 9-Quad Header Kit

Item #	Description	1	2-5	6-11	12-24
342004	Kit	1360.00	1330.00	1300.00	1270.00
Kit Includes: Nine-Quad Square Frame, 6 Graphic Panels, 3 Internal Shelves and Soft Carry Case		USD MSRP (C)			
Shelves do not fit in provided soft carry case. See page 201 for shelf soft carry case.					

Product Size 90"W x 89.5"H x 13"D
Finished Graphic Size View Online Template
Product Wt. 27 lbs.
Media Polyester Double Knit



Deluxe GeoMetrix 9-Quad Classic Kit

Item #	Description	1	2-5	6-11	12-24
342006	Kit	1360.00	1330.00	1300.00	1270.00
Kit Includes: Nine-Quad Square Frame, 4 Graphic Panels, 2 Internal Shelves and Soft Carry Case		USD MSRP (C)			
Shelves do not fit in provided soft carry case. See page 201 for shelf soft carry case.					

Product Size 90"W x 89.5"H x 13"D
Finished Graphic Size View Online Template
Product Wt. 24 lbs.
Media Polyester Double Knit



Deluxe GeoMetrix 3-Quad Tower Kit

Item #	Description	1	2-5	6-11	12-24
342010	Kit	620.00	610.00	595.00	585.00
Kit Includes: Three-Quad Tower Frame, 3 Graphic Panels, 1 Internal Shelf and Soft Carry Case		USD MSRP (C)			
Shelves do not fit in provided soft carry case. See page 201 for shelf soft carry case.					

Product Size 31.25"W x 89.5"H x 13"D
Finished Graphic Size View Online Template
Product Wt. 11 lbs.
Media Polyester Double Knit



Deluxe GeoMetrix 3-Quad Pyramid Kit

Item #	Description	1	2-5	6-11	12-24
342012	Kit	620.00	610.00	595.00	585.00
Kit Includes: Three-Quad Pyramid Frame, 3 Graphic Panels and Soft Carry Case		USD MSRP (C)			

Product Size 84.5"W x 68"H x 13"D
Finished Graphic Size View Online Template
Product Wt. 8 lbs.
Media Polyester Double Knit



Deluxe GeoMetrix 12-Quad Presenter Kit

Item #	Description	1	2-5	6-11	12-24
342018	Kit	1605.00	1575.00	1545.00	1515.00
Kit Includes: Twelve-Quad Frame, 5 Graphic Panels, 2 Internal Shelves and Soft Carry Case		USD MSRP (C)			
Shelves do not fit in provided soft carry case. See page 201 for shelf soft carry case.					

Product Size 118"W x 89.5"H x 13"D
Finished Graphic Size View Online Template
Product Wt. 29.4 lbs.
Media Polyester Double Knit



Deluxe GeoMetrix 12-Quad Classic Kit

Item #	Description	1	2-5	6-11	12-24
342000	Kit	1605.00	1575.00	1545.00	1515.00
Kit Includes: Twelve-Quad Frame, 8 Graphic Panels, 2 Internal Shelves and Soft Carry Case		USD MSRP (C)			
Shelves do not fit in provided soft carry case. See page 201 for shelf soft carry case.					

Product Size 118"W x 89.5"H x 13"D
Finished Graphic Size View Online Template
Product Wt. 30.5 lbs.
Media Polyester Double Knit

SHELVES AND STABILIZER FEET SHIP SAME DAY WHEN ORDERED BEFORE 2 PM CENTRAL
 Setup fee: \$20.00(G); no setup fee on orders placed via our website; see page 224 for details.
 View current graphic templates, assembly videos and instructions on our website.
 See pages 224-226 for additional information that may apply to your order.

AFTER FINAL PROOF APPROVAL
 PRODUCTION LEAD TIME IS
4 DAYS

DELUXE GEOMETRIX CONNECTOR DISPLAY

These brilliant display options feature multiple frames linked together with connector shelves. Edge graphic panels complete the look.

- Impact-resistant clear shelves install in seconds
- Each internal shelf supports up to 15 lbs. and each connector shelf supports up to 5 lbs.
- Artwork is dye sublimated on polyester double knit
- Additional shelves and edge graphic panels can be purchased separately (see pages 197 and 198)
- US Patent #9214104



Deluxe GeoMetrix Narrow Corner Connector Kit

Item #	Description	1	2-5	6-11	12-24
342022	Kit	1195.00	1170.00	1135.00	1110.00
Kit Includes: 2 Three-Quad Tower Frames, 4 Graphic Panels, 4 Clear Internal Shelves, 2 Clear Connector Shelves and 2 Soft Carry Cases					
Shelves do not fit in provided soft carry cases. See page 201 for shelf soft carry case.					
Product Size	Finished Graphic Size	Product Wt.	Media		
51.25"W x 89.5"H x 51.25"D	View Online Template	24.75 lbs.	Polyester Double Knit		

Deluxe GeoMetrix L-Corner Connector Kit

Item #	Description	1	2-5	6-11	12-24
342025	Kit	1685.00	1650.00	1600.00	1565.00
Kit Includes: 1 Nine-Quad Square Frame, 1 Three-Quad Tower Frame, 3 Graphic Panels, 1 Nine-Quad Back Wall, 8 Clear Internal Shelves, 2 Clear Connector Shelves and 2 Soft Carry Cases					
Shelves do not fit in provided soft carry cases. See page 201 for shelf soft carry case.					
Product Size	Finished Graphic Size	Product Wt.	Media		
51.25"W x 89.5"H x 110.25"D	View Online Template	51.35 lbs.	Polyester Double Knit		

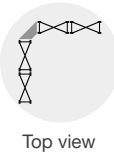

Deluxe GeoMetrix Wide Corner Connector Kit

Item #	Description	1	2-5	6-11	12-24
342028	Kit	2025.00	1985.00	1925.00	1885.00
Kit Includes: 2 Six-Quad Double Stack Frames, 8 Graphic Panels, 4 Clear Internal Shelves, 2 Clear Connector Shelves and 2 Soft Carry Cases		USD MSRP (C)			
Shelves do not fit in provided soft carry cases. See page 201 for shelf soft carry case.					
Product Size	Finished Graphic Size	Product Wt.	Media		
81.25"W x 89.5"H x 81.25"D	View Online Template	42.6 lbs.	Polyester Double Knit		

Deluxe GeoMetrix Nook Connector Kit

Item #	Description	1	2-5	6-11	12-24
342031	Kit	2235.00	2190.00	2125.00	2080.00
Kit Includes: 2 Three-Quad Tower Frames, 1 Six-Quad Double Stack Frame, 9 Graphic Panels, 8 Clear Internal Shelves, 4 Clear Connector Shelves and 3 Soft Carry Cases		USD MSRP (C)			
Shelves do not fit in provided soft carry cases. See page 201 for shelf soft carry case.					
Product Size	Finished Graphic Size	Product Wt.	Media		
101.5"W x 89.5"H x 51.25"D	View Online Template	56.7 lbs.	Polyester Double Knit		

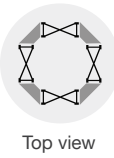

Deluxe GeoMetrix Ring Connector Kit

Item #	Description	1	2-5	6-11	12-24
342034	Kit	3185.00	3120.00	3025.00	2960.00
Kit Includes: 4 Three-Quad Tower Frames, 36 Graphic Panels, 4 Clear Internal Shelves, 8 Clear Connector Shelves and 4 Soft Carry Cases		USD MSRP (C)			
Shelves do not fit in provided soft carry cases. See page 201 for shelf soft carry case.					
Product Size	Finished Graphic Size	Product Wt.	Media		
71.5"W x 89.5"H x 71.5"D	View Online Template	56.7 lbs.	Polyester Double Knit		

Deluxe GeoMetrix Pyramid Corner Connector Kit

Item #	Description	1	2-5	6-11	12-24
342037	Kit	1785.00	1750.00	1695.00	1660.00
Kit Includes: 2 Six-Quad Pyramid Frames, 8 Graphic Panels, 8 Clear Internal Shelves, 2 Clear Connector Shelves and 2 Soft Carry Cases		USD MSRP (C)			
Shelves do not fit in provided soft carry cases. See page 201 for shelf soft carry case.					
Product Size	Finished Graphic Size	Product Wt.	Media		
110.25"W x 89.5"H x 110.25"D	View Online Template	53.2 lbs.	Polyester Double Knit		



Deluxe GeoMetrix Serpentine Connector Kit

Item #	Description	1	2-5	6-11	12-24
342040	Kit	2180.00	2135.00	2070.00	2025.00
Kit Includes: 3 Three-Quad Tower Frames, 10 Graphic Panels, 4 Clear Internal Shelves, 4 Clear Connector Shelves and 3 Soft Carry Cases		USD MSRP (C)			
Shelves do not fit in provided soft carry cases. See page 201 for shelf soft carry case.					
Product Size	Finished Graphic Size	Product Wt.	Media		
71.5"W x 89.5"H x 71.5"D	View Online Template	43.4 lbs.	Polyester Double Knit		

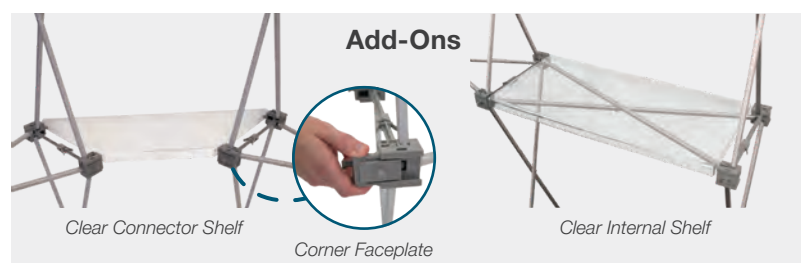

Deluxe GeoMetrix Shelves

Item #	Description	1	2-5	6-11	12-24
338070	Clear Connector Shelf	118.00	114.00	111.00	107.00
338068	Clear Internal Shelf	118.00	114.00	111.00	107.00
338071	Corner Faceplate	6.40	6.20	6.00	5.80
Connector shelf supports up to 5 lbs. Internal shelf supports up to 15 lbs. Connector shelf requires 4 corner faceplates (included with Deluxe GeoMetrix Connector Kits)		USD MSRP (C)			

SHELVES AND CORNER FACEPLATES SHIP SAME DAY WHEN ORDERED BEFORE 2 PM CENTRAL
 Setup fee: \$20.00(G); no setup fee on orders placed via our website; see page 224 for details.
 View current graphic templates, assembly videos and instructions on our website.
 See pages 224-226 for additional information that may apply to your order.

AFTER FINAL PROOF APPROVAL
 PRODUCTION LEAD TIME IS
4 DAYS



Graphic panels shown on partial frames for illustrative purposes only. Partial frames not available for purchase.

GEOMETRIX GRAPHIC PANELS

Create a look that is uniquely yours with our wide variety of graphic panels.

- Designed to attach to the frame at specific, predetermined angles (shown to the left)
- Artwork is dye sublimated on polyester double knit
- Hardware sold separately (complete frames only; see website for details)



GeoMetric and Deluxe GeoMetric Graphic Panels

Item #	Description	1	2-5	6-11	12-24
337000	Graphic Panel A	108.00	106.00	104.00	102.00
337001	Graphic Panel B	108.00	106.00	104.00	102.00
337002	Graphic Panel C	108.00	106.00	104.00	102.00
337003	Graphic Panel D	131.00	128.00	126.00	123.00
337004	Graphic Panel E	131.00	128.00	126.00	123.00
337005	Graphic Panel F	192.00	188.00	184.00	180.00
337006	Graphic Panel G	144.00	141.00	138.00	135.00
337007	Graphic Panel H	150.00	147.00	144.00	141.00
337008	Graphic Panel I	150.00	147.00	144.00	141.00
337021	Graphic Panel J	150.00	147.00	144.00	141.00

GeoMetric pegs hold up to 3 panels each. USD MSRP (C)
 Deluxe GeoMetric pegs hold up to 6 panels each.
 View online templates for finished graphic sizes.

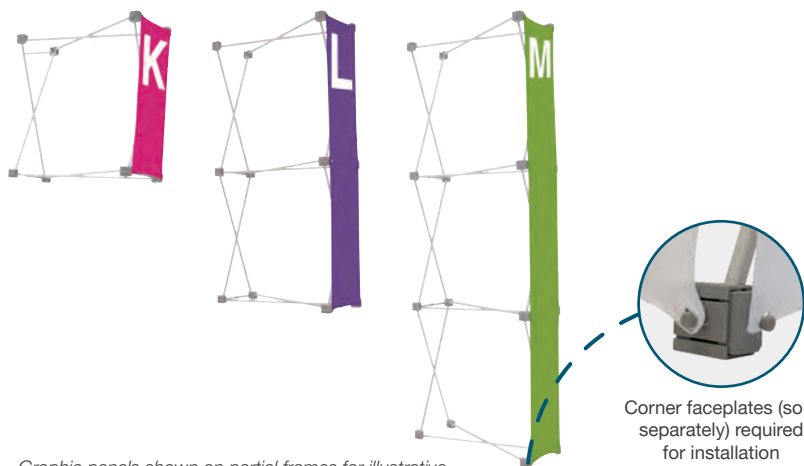

Graphic panels shown on partial frames for illustrative purposes only. Partial frames not available for purchase.

DELUXE GEOMETRIX EDGE PANELS

These graphic panels run along the edge of the Deluxe GeoMetric display to give you even more options for creative layouts.

- Available in three heights
- Artwork is dye sublimated on polyester double knit
- Designed for the edges of Deluxe GeoMetric frames



Deluxe GeoMetric Edge Graphic Panels

Item #	Description	1	2-5	6-11	12-24
337080	Graphic Panel K	42.80	41.50	40.20	38.90
337081	Graphic Panel L	86.00	83.00	81.00	78.00
337082	Graphic Panel M	128.00	124.00	120.00	116.00
338071	Corner Faceplate	6.40	6.20	6.00	5.80

Deluxe GeoMetric pegs hold up to 6 panels each. USD MSRP (C)
 View online templates for finished graphic sizes.

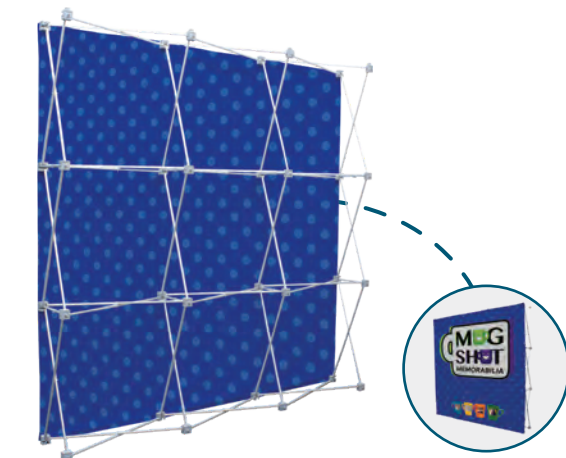

Nine-quad back wall shown on a Deluxe GeoMetric nine-quad square frame (sold separately)

DELUXE GEOMETRIX BACK WALL

Block out background distractions by adding a stylish backdrop to your Deluxe GeoMetric display.

- Super poly knit fabric with an opaque polyester block-out liner that features a double-sided silver acrylic coating
- Buttonholes attach to corresponding pegs on Deluxe GeoMetric frames
- Use with nine-quad and twelve-quad Deluxe GeoMetric kits (see page 195)



Deluxe GeoMetric Back Wall

Item #	Description	1	2-5	6-11	12-24
342060	Nine-Quad Double-Sided Back Wall	430.00	420.00	410.00	400.00
342061	Twelve-Quad Double-Sided Back Wall	515.00	505.00	490.00	480.00

Deluxe GeoMetric pegs hold up to 6 panels each. USD MSRP (C)
 View online templates for finished graphic sizes.

AFTER FINAL PROOF APPROVAL
 PRODUCTION LEAD TIME IS
4 DAYS

CORNER FACEPLATES ONLY LEAD TIME: SHIPS SAME DAY WHEN ORDERED BEFORE 2 PM CENTRAL

Setup fee: \$20.00(G); no setup fee on orders placed via our website; see page 224 for details.

View current graphic templates, assembly videos and instructions on our website.

See pages 224-226 for additional information that may apply to your order.

Suggested Uses:

- Retail
- Museums
- Conferences
- Trade Shows



10' full mural panel kit & lights



ECHO POP-UP DISPLAY

The budget-friendly Echo is a perfect solution for the occasional exhibitor.

- Choose between hook-receptive fabric or mural panels
- Kits available with or without Ultimate LED Double Light Kits
- Case-to-Counter Conversion Kit included



8' Curved Echo

Item #	Description	1	2-5	6-11	12-24
335038	Full Fabric Panel Kit	1147.00	1120.00	1092.00	1065.00
335100	Full Fabric Panel Kit & Lights	1201.00	1174.00	1146.00	1119.00
335040	Center Mural Panels w/Fabric Ends Kit	1530.00	1503.00	1475.00	1448.00
335102	Center Mural Panels w/Fabric Ends Kit & Lights	1585.00	1560.00	1530.00	1505.00
335042	Full Mural Panel Kit	1690.00	1665.00	1635.00	1610.00
335104	Full Mural Panel Kit & Lights	1750.00	1725.00	1695.00	1670.00

Kit Includes: See Kit Options USD MSRP (C)

10' Curved Echo

Item #	Description	1	2-5	6-11	12-24
335039	Full Fabric Panel Kit	1310.00	1283.00	1255.00	1228.00
335101	Full Fabric Panel Kit & Lights	1366.00	1339.00	1311.00	1284.00
335041	Center Mural Panels w/Fabric Ends Kit	1639.00	1612.00	1584.00	1557.00
335103	Center Mural Panels w/Fabric Ends Kit & Lights	1694.00	1667.00	1639.00	1612.00
335043	Full Mural Panel Kit	1912.00	1885.00	1857.00	1830.00
335105	Full Mural Panel Kit & Lights	1967.00	1940.00	1912.00	1885.00

Kit Includes: See Kit Options USD MSRP (C)

Description	Product Size	Finished Graphic Size	Product Wt. (No Lights / With Lights)	Media
8'	100"W x 91.5"H x 31"D	View Online Template	78 lbs. / 82 lbs.	Titan™ No-Curl Laminated Media
10'	123.5"W x 91.5"H x 34.5"D	View Online Template	88.25 lbs. / 92.5 lbs.	Titan™ No-Curl Laminated Media

Kit Options

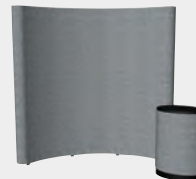

Full Fabric Panel Kit Includes:

- Frame & Channel Bars
- Fabric Center Panels
- Fabric End Panels
- Fabric Case-to-Counter Conversion Kit
- Hard Case with Wheels
- Ultimate LED Double Light Kit (select kits)



Center Mural Panels with Fabric Ends Kit Includes:

- Frame & Channel Bars
- Mural Center Panels
- Fabric End Panels
- Graphic Case-to-Counter Conversion Kit
- Hard Case with Wheels
- Ultimate LED Double Light Kit (select kits)



Full Mural Panel Kit Includes:

- Frame & Channel Bars
- Mural Center & End Panels
- Graphic Case-to-Counter Conversion Kit
- Hard Case with Wheels
- Ultimate LED Double Light Kit (select kits)

Fabric Colors

- Charcoal PMS 424
- Lava PMS Black 6
- Pacific PMS 280
- Steel PMS 429



Lightweight, spring-action frame pops up in seconds.



Locking channel bars hold magnetic panels in place.

FULL FABRIC PANEL KIT LEAD TIME: SHIPS IN 2 DAYS

Setup fee: \$20.00(G); no setup fee on orders placed via our website; see page 224 for details. View current graphic templates, assembly videos and instructions on our website. See pages 224-226 for additional information that may apply to your order.

AFTER FINAL PROOF APPROVAL PRODUCTION LEAD TIME IS **3 DAYS**

SHOW 'N RISE POP-UP DISPLAY

This best-selling pop-up display is perfect for use at multiple events.

- Choose between hook-receptive fabric or mural panels
- Panels attach to magnet rails for easy alignment
- Case-to-Counter Conversion Kit and Ultimate LED Double Light Kit included
- More kits available online
- US Patent #9214104



Suggested Uses:
 Meetings
 Press Conferences
 Dealerships
 School Functions



10' curved full mural panel kit



High-grade aluminum frame with bayonet locking system keeps the display stable.



Shock cord magnet rails for magnet-to-magnet panel registration.

Kit Options



Full Fabric Panel Kit Includes:

- Frame & Magnet Rails
- Fabric Center & End Panels
- Fabric Case-to-Counter Conversion Kit
- Ultimate LED Double Light Kit
- Hard Case with Wheels



Center Mural Panels with Fabric Ends Kit Includes:

- Frame & Magnet Rails
- Mural Center Panels
- Fabric End Panels
- Fabric Case-to-Counter Conversion Kit
- Ultimate LED Double Light Kit
- Hard Case with Wheels



Full Mural Panel Kit Includes:

- Frame & Magnet Rails
- Mural Center & End Panels
- Graphic Case-to-Counter Conversion Kit
- Ultimate LED Double Light Kit
- Hard Case with Wheels

20' Displays Include: 2 Frames, 2 Ultimate LED Double Light Kits and 2 Hard Cases with Wheels

Fabric Colors Charcoal PMS 424 Lava PMS Black 6 Pacific PMS 280 Steel PMS 429



8' Curved Show 'N Rise

Item #	Description	1	2-5	6-11	12-24
339005	Full Fabric Panel Kit	1315.00	1260.00	1205.00	1150.00
339006	Center Mural Panels w/Fabric Ends Kit	1639.00	1584.00	1530.00	1475.00
339007	Full Mural Panel Kit	2080.00	2040.00	1975.00	1935.00

Kit Includes: See Kit Options USD MSRP (C)

Product Size 104"W x 92"H x 31"D Finished Graphic Size View Online Template Product Wt. 83 lbs. Media Titan™ No-Curl Laminated Media



10' Curved Show 'N Rise

Item #	Description	1	2-5	6-11	12-24
339009	Full Fabric Panel Kit	1535.00	1480.00	1425.00	1370.00
339010	Center Mural Panels w/Fabric Ends Kit	1860.00	1805.00	1750.00	1695.00
339011	Full Mural Panel Kit	2294.00	2239.00	2185.00	2130.00

Kit Includes: See Kit Options USD MSRP (C)

Product Size 119"W x 92"H x 36"D Finished Graphic Size View Online Template Product Wt. 93.75 lbs. Media Titan™ No-Curl Laminated Media



10' Straight Show 'N Rise

Item #	Description	1	2-5	6-11	12-24
339013	Full Fabric Panel Kit	1750.00	1700.00	1645.00	1610.00
339014	Center Mural Panels w/Fabric Ends Kit	2080.00	2025.00	1970.00	1915.00
339015	Full Mural Panel Kit	2510.00	2455.00	2400.00	2345.00

Kit Includes: See Kit Options USD MSRP (C)

Product Size 110"W x 92"H x 14"D Finished Graphic Size View Online Template Product Wt. 82.25 lbs. Media Titan™ No-Curl Laminated Media



20' Gullwing Show 'N Rise

Item #	Description	1	2-5	6-11	12-24
339021	Full Fabric Panel Kit	2625.00	2570.00	2515.00	2460.00
339022	Center Mural Panels w/Fabric Ends Kit	3385.00	3275.00	3165.00	3055.00
339023	Full Mural Panel Kit	3823.00	3714.00	3605.00	3495.00

Kit Includes: See Kit Options USD MSRP (C)

Product Size 238"W x 92"H x 36"D Finished Graphic Size View Online Template Product Wt. 177.5 lbs. Media Titan™ No-Curl Laminated Media



This kit converts an oval hard case (sold separately) into a podium. It includes an oval wrap and an oval countertop.

Case-to-Counter Conversion Kit

Item #	Description	Product Wt.	1	2-5	6-11	12-24
112002	Fabric Kit	4.75 lbs.	125.00	121.00	116.00	113.00
190073	Graphic Kit	3.25 lbs.	305.00	300.00	295.00	290.00
112008	UltraFit Kit	2 lbs.	188.80	183.00	177.40	172.90

Kit Includes: Oval Countertop and Oval Wrap
Oval hard case sold separately (see page 216).
View online templates for finished graphic sizes.
Countertop supports up to 20 lbs.
USD MSRP (C)

Add-Ons



Shelf soft carry case holds up to four shelves.

Show 'N Rise Internal Shelf

Item #	Description	Product Wt.	1	2-5	6-11	12-24
338050	Internal Straight Shelf	3 lbs.	111.00	109.00	106.00	102.00
220101	Shelf Soft Carry Case	1.25 lbs.	44.00	43.00	42.00	41.00

Internal shelf supports up to 15 lbs.
USD MSRP (C)

FULL FABRIC PANEL KIT LEAD TIME: SHIPS IN 2 DAYS
HARDWARE ONLY LEAD TIME: SHIPS SAME DAY WHEN ORDERED BEFORE 2 PM CENTRAL
Setup fee: \$20.00(G); no setup fee on orders placed via our website; see page 224 for details.
View current graphic templates, assembly videos and instructions on our website.
See pages 224-226 for additional information that may apply to your order.

AFTER FINAL PROOF APPROVAL
PRODUCTION LEAD TIME IS
3 DAYS

ARISE POP-UP DISPLAY

This pop-up display is specifically engineered for the trade show professional.

- Choose between hook-receptive fabric or mural panels
- Panels attach to magnet bars for easy alignment
- Case-to-Counter Conversion Kit and Ultimate LED Double Light Kit included
- Tabletop versions also available (see page 158)



Suggested Uses:
Trade Shows
In-Store Giveaways
Product Demos
Presentations



Self-locking, high-grade aluminum frame pops up in seconds.



Magnet bars connect to the frame magnetically.

Kit Options

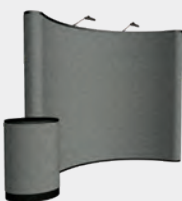

Full Fabric Panel Kit Includes:

- Frame & Magnet Bars
- Fabric Center & End Panels
- Fabric Case-to-Counter Conversion Kit
- Ultimate LED Double Light Kit
- Hard Case with Wheels



Center Mural Panels with Fabric Ends Kit Includes:

- Frame & Magnet Bars
- Mural Center Panels
- Fabric End Panels
- Fabric Case-to-Counter Conversion Kit
- Ultimate LED Double Light Kit
- Hard Case with Wheels



Full Mural Panel Kit Includes:

- Frame & Magnet Bars
- Mural Center & End Panels
- Graphic Case-to-Counter Conversion Kit
- Ultimate LED Double Light Kit
- Hard Case with Wheels

20' Displays Include: 2 Frames, 2 Ultimate LED Double Light Kits and 2 Hard Cases with Wheels

Fabric Colors Charcoal PMS 424 Lava PMS Black 6 Pacific PMS 280 Steel PMS 429



8' Curved ARISE

Item #	Description	1	2-5	6-11	12-24
332222	Full Fabric Panel Kit	1535.00	1480.00	1425.00	1370.00
332246	Center Mural Panels w/Fabric Ends Kit	1860.00	1805.00	1750.00	1695.00
332254	Full Mural Panel Kit	2294.00	2239.00	2185.00	2130.00

Kit Includes: See Kit Options USD MSRP (C)
Product Size 100"W x 89.5"H x 26.25"D **Finished Graphic Size** View Online Template **Product Wt.** 83.25 lbs. **Media** Titan™ No-Curl Laminated Media

20' Gullwing ARISE

Item #	Description	1	2-5	6-11	12-24
332226	Full Fabric Panel Kit	2840.00	2785.00	2731.00	2676.00
332250	Center Mural Panels w/Fabric Ends Kit	3600.00	3490.00	3380.00	3275.00
332258	Full Mural Panel Kit	4095.00	3985.00	3875.00	3765.00

Kit Includes: See Kit Options USD MSRP (C)
Product Size 240"W x 89.5"H x 38.5"D **Finished Graphic Size** View Online Template **Product Wt.** 178 lbs. **Media** Titan™ No-Curl Laminated Media



10' Curved ARISE

Item #	Description	1	2-5	6-11	12-24
332223	Full Fabric Panel Kit	1750.00	1695.00	1640.00	1585.00
332247	Center Mural Panels w/Fabric Ends Kit	2080.00	2025.00	1970.00	1915.00
332255	Full Mural Panel Kit	2510.00	2455.00	2400.00	2345.00

Kit Includes: See Kit Options USD MSRP (C)
Product Size 120.75"W x 89.5"H x 38.5"D **Finished Graphic Size** View Online Template **Product Wt.** 94 lbs. **Media** Titan™ No-Curl Laminated Media

10' Straight ARISE

Item #	Description	1	2-5	6-11	12-24
332224	Full Fabric Panel Kit	1750.00	1695.00	1640.00	1585.00
332248	Center Mural Panels w/Fabric Ends Kit	2080.00	2025.00	1970.00	1915.00
332256	Full Mural Panel Kit	2510.00	2455.00	2400.00	2345.00

Kit Includes: See Kit Options USD MSRP (C)
Product Size 109.5"W x 89.5"H x 12.5"D **Finished Graphic Size** View Online Template **Product Wt.** 86 lbs. **Media** Titan™ No-Curl Laminated Media



This kit converts an oval hard case (sold separately) into a podium. It includes an oval wrap and an oval countertop.

Add-Ons

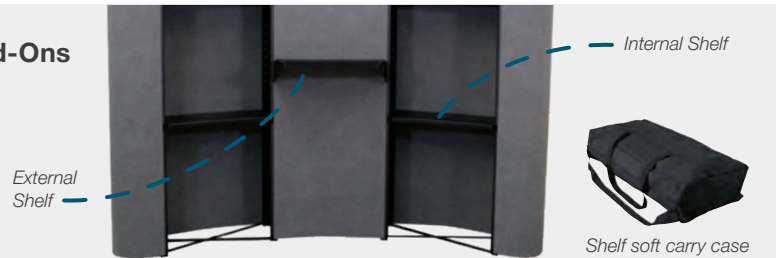

Case-to-Counter Conversion Kit

Item #	Description	Product Wt.	1	2-5	6-11	12-24
112002	Fabric Kit	4.75 lbs.	125.00	121.00	116.00	113.00
190073	Graphic Kit	3.25 lbs.	305.00	300.00	295.00	290.00
112008	UltraFit Kit	2 lbs.	188.80	183.00	177.40	172.90

Kit Includes: Oval Countertop and Oval Wrap
 Oval hard case sold separately (see page 216).
 View online templates for finished graphic sizes.
 Countertop supports up to 20 lbs. USD MSRP (C)

ARISE Shelves

Item #	Description	Product Wt.	1	2-5	6-11	12-24
330018	ARISE External Curve Shelf Kit	2 lbs.	130.00	128.00	126.00	124.00
290036	ARISE Internal Curve Shelf Only	3 lbs.	120.00	118.00	116.00	113.00
331039	ARISE Internal Straight Shelf Only	3 lbs.	125.00	120.00	114.00	109.00
220101	Shelf Soft Carry Case	1.25 lbs.	44.00	43.00	42.00	41.00

Shelf Kit Includes: Shelf and 2 Brackets
 External shelf supports up to 10 lbs.
 Internal shelves support up to 15 lbs. USD MSRP (C)

FULL FABRIC PANEL KIT LEAD TIME: SHIPS IN 2 DAYS
HARDWARE ONLY LEAD TIME: SHIPS SAME DAY WHEN ORDERED BEFORE 2 PM CENTRAL
 Setup fee: \$20.00(G); no setup fee on orders placed via our website; see page 224 for details.
 View current graphic templates, assembly videos and instructions on our website.
 See pages 224-226 for additional information that may apply to your order.

AFTER FINAL PROOF APPROVAL
 PRODUCTION LEAD TIME IS
3 DAYS



1. Direct View page 212 | 2. Impress Counter page 209 | 3. Boost Ball page 213

STANDS & FURNITURE

When choosing a stand or furniture **have you considered...**

- **SIZE** - What is the size of your space?
- **FREQUENCY** - How often will you be setting up and taking down your stand or furniture?
- **TRANSPORT** - How will this item be transported?
- **LIGHTING** - Will this be set up in a brightly lit space, or does it need its own lighting?
- **POWER** - Will power be available?



POWER PEDESTAL

Let your guests charge their mobile devices at this handy pedestal, covered in a full-color design that shows off your logo or marketing message.

- Chargers for Lightning, Micro USB and USB Type-C are included
- Silicone edge graphic (SEG) for easy graphic panel installation
- Graphic panel is dye sublimated on two-way stretch fabric
- Surface grip decal is removable and repositionable
- Aluminum tubing structure with composite wood surfaces
- A power strip (not included) is recommended for use with this product
- Tabletop supports up to 20 lbs.



Power Pedestal

Item #	Description	1	2-5	6-11	12-24
257080	Kit	985.00	955.00	925.00	900.00
257083	Kit with Tabletop Decal	999.00	967.00	936.00	906.00

Kit Includes: Hardware, Graphic Panel and Soft Carry Case USD MSRP (C)

Product Size: 27.5"W x 36.875"H x 27.5"D Finished Graphic Size: View Online Template Product Wt. (Kit / Kit w/Decal): 19 lbs. / 19.5 lbs. Media (Panel / Decal): Two-Way Stretch Fabric / Surface Grip



Charging cables are guided through holes in the pedestal's tabletop.



With a quick press of your thumb, the fabric's gasket edge is pushed into a narrow channel built into the tabletop and base.



Cover the tabletop with a full-color decal (included in kit #257083 or sold separately).



Joints are labeled for step-by-step assembly.

Setup fee: \$20.00(G); no setup fee on orders placed via our website; see page 224 for details.
View current graphic templates, assembly videos and instructions on our website.
See pages 224-226 for additional information that may apply to your order.

AFTER FINAL PROOF APPROVAL
PRODUCTION LEAD TIME IS
4 DAYS



Collapsible aluminum frame makes it easy to take down and store when not in use.



COUNTERPOP

Combining the features of a counter and a pop-up display, the CounterPop is a truly multifunctional display.

- Artwork is dye sublimated on polyester knit
- Countertop supports up to 30 lbs.; internal shelf supports up to 10 lbs.



CounterPop

Item #	Description	1	2-5	6-11	12-24
257055	Kit	484.00	473.00	456.00	445.00

Kit Includes: Hardware, Graphic Panel and Soft Carry Case USD MSRP (C)

Product Size	Finished Graphic Size	Product Wt.	Media
41.75"W x 40"H x 15.75"D	View Online Template	22.25 lbs.	Polyester Knit



Back view



MDF countertop and internal shelf with woodgrain laminate.

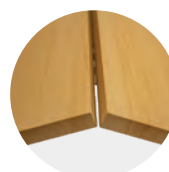

Countertop folds in half for convenient storage.



Hook-and-loop fasteners make it easy to install the graphic panel.

4DAYS
AFTER FINAL PROOF APPROVAL
PRODUCTION LEAD TIME IS

Setup fee: \$20.00(G); no setup fee on orders placed via our website; see page 224 for details.
View current graphic templates, assembly videos and instructions on our website.
See pages 224-226 for additional information that may apply to your order.



Stunning on the show floor, convenient in storage.



SHOWGOER CASE-TO-PODIUM

Take your display on the go. This podium converts into a wheeled case for simple, worry-free transportation.

- Dye-sublimated wrap slides on for easy setup
- Durable, roto-molded case
- Removable top and built-in tray for quick access to your show materials
- Countertop supports up to 20 lbs.



ShowGoer Case-to-Podium

Item #	Description	1	2-5	6-11	12-24
257030	Kit	545.00	535.00	525.00	505.00
257031	Hard Case with Wheels Only	330.00	325.00	320.00	310.00

Kit Includes: Hard Case with Wheels and Graphic Wrap USD MSRP (C)

Product Size	Finished Graphic Size	Product Wt.	Media
38.375"W x 34.875"H x 16.875"D	View Online Template	27.5 lbs.	Two-Way Stretch Fabric



Holds up to three 24"-33.5" Economy retractors.



Wheels and pull-up handle make transport easy.

Setup fee: \$20.00(G); no setup fee on orders placed via our website; see page 224 for details. View current graphic templates, assembly videos and instructions on our website. See pages 224-226 for additional information that may apply to your order.

AFTER FINAL PROOF APPROVAL
PRODUCTION LEAD TIME IS
4 DAYS



LIGHTS UP!

SHOWGLOWER PODIUM

Shine some light on your message or brand with this backlit podium.

- The MDF tabletop offers a great deal of usable surface
- Silicone edge graphics (SEG) for easy graphic panel installation
- Artwork is dye sublimated on premium woven polyester
- Countertop supports up to 30 lbs.



ShowGlower Podium

Item #	Description	1	2-5	6-11	12-24
257064	Kit	700.00	681.00	662.00	643.00
Kit Includes: Hardware, Ladder Lights, Graphic Panel and Soft Carry Case				USD MSRP (C)	
Product Size		Finished Graphic Size	Product Wt.	Media	
31.5"W x 39.75"H x 20.875"D		View Online Template	31.5 lbs.	Premium Woven Polyester	



Joints are labeled for step-by-step assembly.



With a quick press of your thumb, the fabric's gasket edge is pushed into a narrow channel built into the countertop and base.



LED ladder lights give this display a warm, pleasant glow.

AFTER FINAL PROOF APPROVAL
PRODUCTION LEAD TIME IS
4 DAYS

HARDWARE ONLY LEAD TIME: SHIPS SAME DAY WHEN ORDERED BEFORE 2 PM CENTRAL
Setup fee: \$20.00(G); no setup fee on orders placed via our website; see page 224 for details.
View current graphic templates, assembly videos and instructions on our website.
See pages 224-226 for additional information that may apply to your order.



Rectangle



Oval

IMPRESS COUNTERS

These easy-to-assemble counters feature your full-color artwork on the outside and storage space on the inside.

- Silicone edge graphics (SEG) for easy graphic panel installation
- Artwork is dye sublimated on two-way stretch fabric
- Black MDF countertop
- Countertop supports up to 20 lbs.



Impress Rectangle Counter

Item #	Description	1	2-5	6-11	12-24
257047	Kit	455.00	441.00	428.00	414.00

Kit Includes: Hardware, Graphic Panel and Soft Carry Case USD MSRP (C)

Product Size	Finished Graphic Size	Product Wt.	Media
31.5"W x 39.75"H x 20.875"D	View Online Template	23.5 lbs.	Two-Way Stretch Fabric

Impress Oval Counter

Item #	Description	1	2-5	6-11	12-24
257044	Kit	402.00	390.00	378.00	366.00

Kit Includes: Hardware, Graphic Panel and Soft Carry Case USD MSRP (C)

Product Size	Finished Graphic Size	Product Wt.	Media
23.375"W x 39.75"H x 15.5"D	View Online Template	16 lbs.	Two-Way Stretch Fabric



Threaded poles twist together for easy setup.



With a quick press of your thumb, the fabric's gasket edge is pushed into a narrow channel built into the countertop and base.



Zippered back creates an enclosed storage area.



Rubber feet for stability.

Setup fee: \$20.00(G); no setup fee on orders placed via our website; see page 224 for details. View current graphic templates, assembly videos and instructions on our website. See pages 224-226 for additional information that may apply to your order.

AFTER FINAL PROOF APPROVAL
PRODUCTION LEAD TIME IS
4 DAYS

Suggested Uses:
Trade Shows
Job Fairs
Lobbies
Salons



Tablet holder adjusts diagonally, creating a secure grip on the corners of your tablet.

Hook-and-loop fasteners make banner changes easy.

TABLET STAND

Stand out with a cost-effective kiosk that keeps your tablet safe and secure.

- Constructed of steel and ABS plastic
- Heavy-duty base keeps display stable
- Fits tablets from 9.7" to 12.9" (measured diagonally)
- 59" cable lock and assembly tools included
- Tablet not included



Tablet Stand

Item #	Description	1	2-5	6-11	12-24
338129	Kit	201.00	195.00	189.00	183.00
Kit Includes: Hardware, Universal Tablet Holder, Banner and Banner Attachment Clips				USD MSRP (C)	
Product Size		Finished Graphic Size	Product Wt.	Media	
12.75"W x 48"H x 16.625"D		10"W x 28"H	18 lbs.	Titan™ No-Curl Laminated Media	



SAIL TABLET STANDS

Turn your tablet into a marketing kiosk with this stylish stand.

- Artwork is dye sublimated on super poly knit fabric
- Graphic cover is double-sided
- Clamp adjusts diagonally, creating a secure grip on the corners of your tablet
- Fits tablets from 9.7" to 12.9" (measured diagonally)
- 59" cable lock and assembly tools included
- Tablet not included



Sail Tablet Stands

Item #	Description	1	2-5	6-11	12-24
230036	Sail Tablet Stand Kit	320.00	310.00	300.00	290.00
230050	Tall Sail Tablet Stand Kit	345.00	340.00	330.00	320.00
Kit Includes: Hardware, Universal Tablet Holder, Double-Sided Graphic Cover and Soft Carry Case				USD MSRP (C)	
Description		Product Size	Finished Graphic Size	Product Wt.	Media
Sail Tablet Stand		10"W x 43.875"H x 22"D	View Online Template	14.75 lbs.	Super Poly Knit Fabric
Tall Sail Tablet Stand		10"W x 57"H x 19"D	View Online Template	15.3 lbs.	Super Poly Knit Fabric



TABLET STAND | SAIL STAND
AFTER FINAL PROOF APPROVAL
PRODUCTION LEAD TIME IS
2 OR 4 DAYS

Setup fee: \$20.00(G); no setup fee on orders placed via our website; see page 224 for details.
View current graphic templates, assembly videos and instructions on our website.
See pages 224-226 for additional information that may apply to your order.

Suggested Uses:
 Job Fairs
 Trade Shows
 Museum Exhibits
 Sales Events

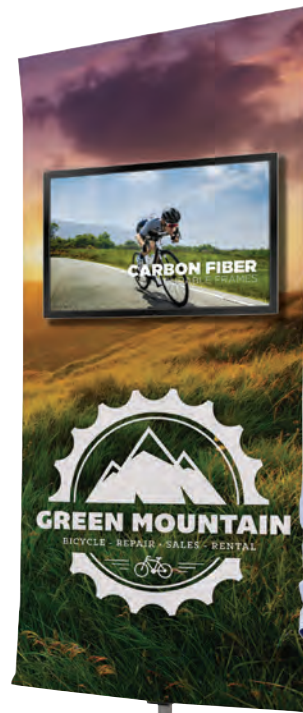

QUAD POD MONITOR STAND

This innovative monitor stand combines stability with style. A large fabric banner behind the monitor gives you ample space for branding or messaging.

- Artwork is dye sublimated on polyester knit
- Heavy-duty anodized aluminum frame is lightweight and easy to set up
- Four legs for stability
- Designed for use with 24" to 42" monitors (measured diagonally)
- Monitor not included



Quad Pod Monitor Stand

Item #	Description	1	2-5	6-11	12-24
255095	Kit	699.00	679.00	654.00	638.00
255096	Hardware Only	469.00	454.00	439.00	428.00
Kit Includes: Hardware, Banner and Soft Carry Case					USD MSRP (C)
Product Size	Recommended Monitor Size	Finished Graphic Size	Product Wt.	Media	
51.25"W x 79.125"H - 89.125"H x 31.25"D	Up to 42" not exceeding 30 lbs.	View Online Template	14.5 lbs.	Polyester Knit	



Universal X-mount system (patent pending) is compatible with a wide variety of monitor brands (monitor not included).

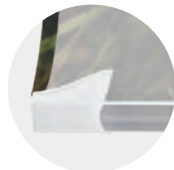

Fabric banner installs by sliding the built-in pockets over rails on the frame.



Hard plastic feet feature rubber pads to prevent the unit from sliding on smooth surfaces.

EASELS

Display announcements, artwork, sign frames and more with these versatile and durable easels.

- Extendable legs allow for use as a tabletop display or standalone floor display
- Tripod structure for easy placement in corners
- Each easel holds up to 20 lbs.



Easels

Item #	Description	1	2-5	6-11	12-24
400011	Presto Easel	60.00	58.00	53.00	51.00
400052	Jumbo Easel	96.00	92.00	88.00	84.00
					USD MSRP (C)
Description	Product Size	Product Wt.			
Presto Easel	38"W x 20"-63.625"H x 32"D	2 lbs.			
Jumbo Easel	20"W x 24"-72"H x 16"D	4.5 lbs.			



Top clamp secures rigid signboards in place.

HARDWARE ONLY LEAD TIME: SHIPS SAME DAY WHEN ORDERED BEFORE 2 PM CENTRAL
 Setup fee: \$20.00(G); no setup fee on orders placed via our website; see page 224 for details.
 View current graphic templates, assembly videos and instructions on our website.
 See pages 224-226 for additional information that may apply to your order.

AFTER FINAL PROOF APPROVAL
 PRODUCTION LEAD TIME IS
4 DAYS



Collapsed

Black display shown with decal (sold separately)



Collapsed

White display shown with decal (sold separately)

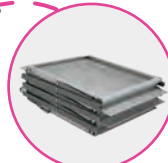

Collapsed



Collapsed

DIRECT VIEW DISPLAY

- Decal (sold separately) lets you personalize the front of the stand
- Four-tier design with polycarbonate trays
- Collapses to fit into included soft carry case
- Stores literature when not in use
- Available in black or white
- Curved pocket size: 9"W x 13.875"H x 1.625"D

Display Colors ● Black ○ White

EASY VIEW DISPLAY

- Decal (sold separately) lets you personalize the front of the stand
- Five-tier design with plastic trays
- Collapses to fit into included soft carry case
- Stores literature when not in use
- Available in black or white
- Pocket size: 8.5"W x 12.375"H x 1.375"D

Display Colors ● Black ○ White

Z DISPLAY

- Six-tier design (three on each side) with acrylic and metal trays
- Sturdy chrome base
- Collapses to fit into included hard carry case
- Pocket size: 10"W x 12.5"H x 0.88"D

CLEAR VIEW DISPLAY

- Four-tier design with acrylic trays
- Sturdy chrome base
- Stores literature when not in use
- Collapses to fit into included soft carry case
- Pocket size: 9.25"W x 14"H x 1.34"D

LITERATURE DISPLAYS

Keep your brochures and catalogs prominently displayed with these compact literature displays.



Literature Displays

Item #	Description	Pocket	1	2-5	6-11	12-24
230024	Direct View Display	1.625"D	295.00	285.00	275.00	270.00
230025	Easy View Display	1.375"D	295.00	285.00	275.00	270.00
230005	Z Display	0.88"D	240.00	235.00	230.00	220.00
230003	Clear View Display	1.34"D	171.00	165.00	159.00	153.00
261244	Display Mate		85.00	82.00	80.00	77.00

USD MSRP (C)

Literature Display Decals

Item #	Description	Finished Graphic Size	1	2-5	6-11	12-24
230026	Direct View Decal	9.25"W x 14.5"H	13.90	12.90	12.10	11.50
230027	Easy View Decal	8.5"W x 13.5"H	13.90	12.90	12.10	11.50

Decal will NOT come applied when purchased with the display. USD MSRP (C)

Description	Product Size	Product Wt.	Media
Direct View	11.125"W x 64.25"H x 13.625"D	14.5 lbs.	Surface Grip
Easy View	10.75"W x 61.5"H x 14.625"D	11.75 lbs.	Surface Grip
Z	11.125"W x 58.25"H x 13.63"D	16.5 lbs.	NA
Clear View	10"W x 60.75"H x 11"D	11.5 lbs.	NA
Display Mate	13"W x 39.5"H x 15.125"D	6.4 lbs.	NA



DISPLAY MATE

- Designed for use with select retractor and banner stands
- Lightweight and portable
- U-shaped steel base slides easily under display bases
- Easy to assemble
- Holds up to 3 pounds or 300 sheets of paper
- Assembly tools included



AFTER FINAL PROOF APPROVAL
PRODUCTION LEAD TIME IS
2 DAYS

HARDWARE ONLY LEAD TIME: SHIPS SAME DAY WHEN ORDERED BEFORE 2 PM CENTRAL
Setup fee: \$20.00(G); no setup fee on orders placed via our website; see page 224 for details.
View current graphic templates, assembly videos and instructions on our website.
See pages 224-226 for additional information that may apply to your order.

Suggested Uses:
 Meeting Spaces
 Libraries
 Offices
 Trade Shows

BOOST BALL CHAIR

With this trendy chair, your message is always on the ball.

- Steel base keeps the ball secure
- Cover is made of foam-backed polyester
- Includes inflatable ball and hand pump
- Supports up to 250 lbs.



Boost Ball Chair

Item #	Description	1	2-5	6-11	12-24
211120	Kit	205.00	199.00	193.00	186.00
Kit Includes: Steel Base, Inflatable Ball, Graphic Cover and Hand Pump		USD MSRP (C)			

Product Size 16.625"W x 20"H x 16.625"D
Finished Graphic Size View Online Template
Product Wt. 7.75 lbs.
Media Foam-Backed Polyester



Hook-and-loop fasteners keep the cover secure.



Hand pump included for easy inflation.



DIRECTOR'S CHAIR

This classic chair design is casual, functional and versatile.

- Made in the USA from Appalachian Beech hardwood
- Natural woodgrain will have some color and pattern variation
- Heavy-duty canvas seat and seat backing
- Supports up to 225 lbs.
- Our floor display hard case with wheels (Item #220023) will hold two director's chairs (sold separately; see page 216)



Unimprinted

Item #	Description	1	2-5	6-11	12-24
111025	Table-Height	158.00	157.00	156.00	154.00
111029	Bar-Height	183.00	182.00	181.00	179.00
Stock fabric colors		USD MSRP (C)			



Full-Color Imprint

Item #	Description	1	2-5	6-11	12-24
111026	Table-Height	170.00	169.00	168.00	166.00
111030	Bar-Height	207.00	206.00	204.00	203.00
Stock fabric colors imprinted with any color(s)		USD MSRP (C)			

Description Table-Height Bar-Height
Product Size 23"W x 34.25"H x 18"D (Seat Height 18") 24.125"W x 46.5"H x 21"D (Seat Height 30.25")
Finished Graphic Size 13"W x 4.5"H 13"W x 4.5"H
Product Wt. 11 lbs. 14 lbs.

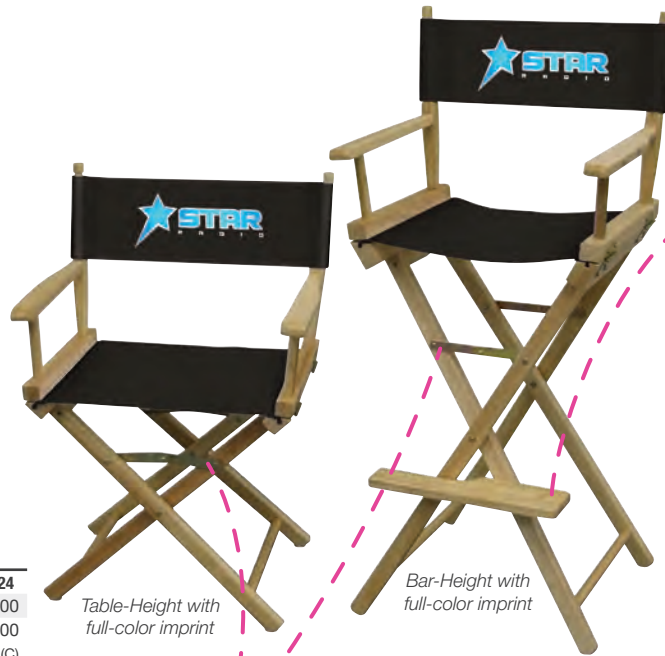

Table-Height with full-color imprint

Bar-Height with full-color imprint



The Bar-Height chair features a footrest that naturally folds out as you open it.



Hinges lock to keep the chair stable.

Stock Canvas Colors

- Black
- Burgundy PMS 7421
- Hunter Green PMS 3302
- Khaki PMS 7502
- Navy Blue PMS 2767
- Orange PMS 1655
- Red PMS 186
- Royal Blue PMS 2738
- White

PMS colors are for reference only and may vary slightly from actual color.

UNIMPRINTED DIRECTOR'S CHAIR LEAD TIME: SHIPS SAME DAY WHEN ORDERED BEFORE 2 PM CENTRAL
 Setup fee: \$20.00(G); no setup fee on orders placed via our website; see page 224 for details.
 View current graphic templates, assembly videos and instructions on our website.
 See pages 224-226 for additional information that may apply to your order.

DIRECTOR'S CHAIR | BOOST BALL
37 DAYS
 AFTER FINAL PROOF APPROVAL
 PRODUCTION LEAD TIME IS

OPULENT DIGITAL DISPLAYS

Our first fully-digital product, these opulent displays feature a high-end LED Samsung monitor that gives you the freedom to change your message.

- Create your own dynamic digital content to make a lasting first impression
- Excellent for featuring company videos and slideshows, daily events, special welcoming messages or way-finding directories
- Digital content can be played on a loop, allowing you to communicate more than one message
- Heavy-duty construction allows for long-term use in one location
- Display is single-sided
- Remote control included
- No assembly required
- Must ship by truck



Suggested Uses:
Airports
Clinics
Conference Halls
Shopping Malls



Sleek and slim steel frame keeps display sturdy and provides a streamlined look.



13° angle



Wheels on the frame make it easy to move display across the floor.

8mm steel plate base for stability.

Opulent Digital Tower

Item #	Description	1	2-5	6-11	12-24
257134	Kit	3800.00	3725.00	3650.00	3535.00

Kit Includes: Hardware and Installed Monitor USD MSRP (C)

Product Size	Monitor Size	Product Wt.
22.125"W x 71.375"H x 18"D	43"	109 lbs.

Opulent Digital Incline

Item #	Description	1	2-5	6-11	12-24
257131	Kit	3400.00	3330.00	3265.00	3160.00

Kit Includes: Hardware and Installed Monitor USD MSRP (C)

Product Size	Monitor Size	Product Wt.
22"W x 48.75"H x 18"D	43"	63 lbs.

A SUPERIOR MONITOR FOR SUPERIOR MARKETING



Monitor only shown (not sold separately)



16:9 screen ratio.

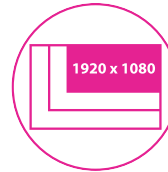

Features a 1920 x 1080 full HD resolution LED monitor.

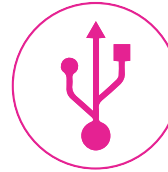

USB socket for simple digital content management and presentation.



Can be web-enabled.

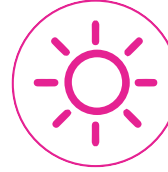

Brightness levels built for high-ambient light conditions.



Monitor is not a touch-screen.



View current assembly videos and instructions on our website.
See pages 224-226 for additional information that may apply to your order.

PRODUCTION LEAD TIME IS
2 DAYS

HARD CASES

Add extra protection to your investment with a wide selection of hard case options.

- Hard cases feature easy-grip handles or straps
- Cases have a one-year warranty



Oval Hard Case with Wheels
Best for floor displays like the ARISE, Show 'N Rise, and Echo (Case-to-counter conversion sold separately).



Round Hard Case with Wheels
Compatible with a variety of our retractors and banner displays.



10' or 15' Tent Hard Case with Wheels
Holds 10' or 15' tent frames (Not for use with 10' Compact tent frame).



Square Hard Case with Wheels
Our most versatile carrying case; perfect for floor displays, retractable banners, and tabletop displays.



Display Hard Carry Case
Ideal for Fast Trak, Dynamo and Show 'N Write displays.



Floor Display Hard Case with Wheels
Accommodates a vast array of floor displays and flat graphics.



Plastic Case with Wheels
Ideal for banner displays and trade show accessories.



Graphix Tube
Perfect storage solution for large rolled graphic panels.

Hard Cases

Item #	Description	Product Size	Product Wt.	1	2-5	6-11	12-24
220017	Oval Hard Case with Wheels	26.25"W x 38.5"H x 17.5"D	24 lbs.	420.00	410.00	400.00	385.00
220024	Round Hard Case with Wheels	15"W x 42"H x 18.5"D	13.5 lbs.	265.00	260.00	255.00	250.00
220150	10' or 15' Tent Hard Case with Wheels	16.25"W x 66.88"H x 16.5"D	22 lbs.	324.00	314.00	305.00	295.00
220011	Square Hard Case with Wheels	15.5"W x 41.25"H x 17"D	22.25 lbs.	365.00	355.00	345.00	330.00
220018	Display Hard Carry Case	39"W x 27.25"H x 4.5"D	10 lbs.	310.00	305.00	300.00	290.00
220020	Floor Display Hard Case with Wheels	43.75"W x 34.25"H x 8"D	22 lbs.	485.00	480.00	475.00	465.00
220023	Floor Display Hard Case with Wheels	57"W x 26.5"H x 10"D	28 lbs.	505.00	500.00	495.00	485.00
CCH1242	Plastic Case with Wheels*	12"W x 46.75"H x 12"D	9.5 lbs.	370.00	365.00	360.00	350.00
CCH1250	Plastic Case with Wheels*	12.25"W x 54.5"H x 12.25"D	11 lbs.	385.00	380.00	375.00	370.00
220074	Graphix Tube*	36"W x 4.5"D	2 lbs.	16.40	15.30	14.30	13.60

Hard cases cannot be imprinted.

* Not intended to be shipped or checked as luggage.

USD MSRP (C)

**HARDWARE SHIPS
SAME DAY**
WHEN ORDERED BEFORE 2PM CENTRAL

View current assembly videos and instructions on our website.
See pages 224-226 for additional information that may apply to your order.

SOFT CARRY CASES

Our broad selection of cases helps you protect your investment by making transportation and storage simple.

- Soft carry cases are constructed of 600 denier polyester and feature straps
- Cases have a one-year warranty (except for the zip-up clear poly bag)
- Color of soft carry cases may vary

**NEW
PRODUCT**



Table Throw Soft Carry Case

Best for rolled table throws.



Table Throw Messenger Bag

Best for folded table throws; features shoulder straps for easy transportation.

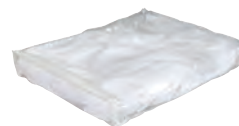

Zip-Up Clear Poly Bag

Ideal for folded table throws.

**MORE
OPTIONS
ONLINE**



Soft Carry Case

Perfect for Splash, GeoMetrix and Deluxe GeoMetrix Floor Displays. Multiple case sizes available.



Tabletop Displays Soft Carry Case

Keeps tabletop displays safe and snug.



**Universal Retractor Case
36.25"W x 3.75"H x 5.25"D**

Perfect for 31.5" & 33.5" Economy, Economy Plus and Ideal retractors.



**Universal Retractor Case
38"W x 4"H x 12"D**

Works well with several of our retractors.

Soft Carry Cases

Item #	Description	Product Size	Product Wt.	1	2-5	6-11	12-24
220009G	Table Throw Soft Carry Case	38"W x 5"H x 5"D	0.75 lb.	36.00	35.00	34.00	32.00
220107	Table Throw Messenger Bag	12.75"W x 13.5"H x 3"D	0.4 lb.	33.60	31.20	29.20	27.90
220069	Zip-Up Clear Poly Bag	14.5"W x 17"H x 3"D	0.25 lb.	3.15	3.10	3.05	3.00
220010G	Soft Carry Case	34"W x 16"H x 14"D	2.25 lbs.	97.00	94.00	91.00	88.00
220007G	Soft Carry Case	38"W x 25"H x 5"D	2.5 lbs.	43.00	42.00	40.00	39.00
220085	Universal Retractor Case	36.25"W x 3.75"H x 5.25"D	2 lbs.	57.00	55.00	53.00	51.00
220055	Universal Retractor Case	38"W x 4"H x 12"D	4.5 lbs.	65.00	63.00	61.00	59.00

Soft carry cases cannot be imprinted.

USD MSRP (C)

ULTIMATE LED LIGHT KITS

Shine some light on your display with these kits, available in single-light and double-light versions.

- 11.75" stalk puts almost a foot of distance between the light and the display
- Adjustable joints at both ends of the unit let you angle each light to maximize impact
- Interchangeable attachments feature a clamp or clip, each compatible with a broad variety of displays
- Each light is powered by an attached 10' USB cord
- Soft carry case included



Removable clamp can be attached to a wide range of products, including retractors and the underside of tables.



Removable clip slides onto the frames of pop-up displays and can also be used with the EuroFit light clamp (sold separately).



AC adapter features AC Receptacle and 2 USB Ports.



EuroFit light clamp (sold separately) attaches Ultimate LED Light Kits to horizontal tubing on compatible EuroFit displays.



Ultimate LED Light Kits

Item #	Description	1	2-5	6-11	12-24
150120	Ultimate LED Single Light Kit	144.00	140.00	135.00	131.00
150121	Ultimate LED Double Light Kit	270.00	260.00	255.00	245.00

Kit Includes: Light(s), Clamp(s), Clip(s), USB Adapter and Soft Carry Case

EuroFit Light Clamp

Item #	Description	1	2-5	6-11	12-24
255125	Light Clamp	5.40	5.20	5.10	4.90

USD MSRP (C)

View current assembly videos and instructions on our website.
See pages 224-226 for additional information that may apply to your order.

**HARDWARE SHIPS
SAME DAY**
WHEN ORDERED BEFORE 2PM CENTRAL



1. Tailgater Total Show Package page 223

TOTAL SHOW PACKAGES

When choosing a total show package **have you considered...**

- **TIME** - Save time by purchasing products kitted to your specific event needs.
- **INSPIRATION** - Take the guesswork out of pairing products; every Total Show Package is designed to work together for a complete look and feel.
- **COST SAVINGS** - Get more for less when you buy pre-bundled products.
- **VARIETY** - There's a Total Show Package for every event and setting; more packages available online.

Suggested Uses:

- Trade Shows
- Conferences
- College Recruiting
- Hospitals

TABLETOP CLASSIC

Our #1 Total Show Package is a triple threat, featuring three of our best-selling products.

- Lightweight and portable
- Includes hard shipping case with wheels



Hard case with wheels

Cases



Table throw messenger bag



Table not included in package

TOTAL SHOW PACKAGES

Item # 390023 - Tabletop Classic Total Show Package

Total Show Package Includes:		Price		Price	
146015	6' Fast Trak Display with Full Graphic Panels	675.00	220107	Table Throw Messenger Bag	33.60
261002	33.5" Economy Plus Retractor Kit (No-Curl Hybrid Media)	338.00	220020	Hard Case with Wheels	485.00
104014	6' / 8' Convertible Table Throw (Full-Color Front Only)	255.00		3 Setup Fees	60.00 FREE
Special pricing, substitutions not allowed				Regular Price	1846.60
				Special Package Price	1607.94
				SAVE	238.66
					USD MSRP (C)



8' draped throw can be converted down to a 6' fitted throw.

Suggested Uses:

- Registrations
- School Clubs
- Sporting Events
- Demonstrations

TRUNK-TO-ANYWHERE

Big messages fit into compact spaces with this portable package.

- Three Economy Retractors can be used for individual concepts or together to create an 8' back wall
- Case transforms into a podium



Closed case with wheels

Everything fits nicely into the included Case-to-Podium.



Item #390024 - Trunk-to-Anywhere Total Show Package

Total Show Package Includes:		Price		Price	
261134	3 - 31.5" Economy Retractor Kits (No-Curl Hybrid Media)	753.00	257030	ShowGoer Case-to-Podium Kit	545.00
Special pricing, substitutions not allowed				4 Setup Fees	80.00 FREE
				Regular Price	1378.00
				Special Package Price	1168.20
				SAVE	209.80
					USD MSRP (C)

Please note: Substitutions not allowed. View current graphic templates, assembly videos and instructions on our website. See pages 224-226 for additional information that may apply to your order.

AFTER FINAL PROOF APPROVAL
PRODUCTION LEAD TIME IS
4 DAYS

Suggested Uses:
Trade Shows
Promotions
Meetings
Sale Kits



Table not included in package

CHANGE-UP

This package offers an attractive tabletop solution that is easy to set up and take down.

- Two EuroFit Straight Walls look great on any tabletop
- 8' draped throw can be converted down to a 6' form-fitting throw

One Package, Three Looks

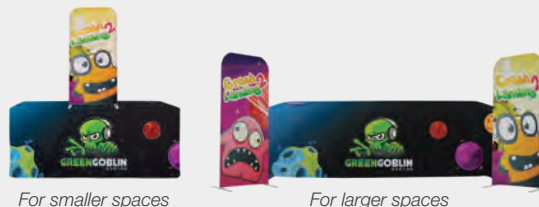

For smaller spaces

For larger spaces

Item #390028 - Change-Up Total Show Package

Total Show Package Includes:		Price	Price
104022	6'/8' Convertible Throw (Full-Color Full-Bleed)	320.00	254603
	2 - 2'W x 49.5"H EuroFit Tabletop Straight Wall Kits		324.00
	3 Setup Fees		FREE 60.00
	Regular Price		704.00
	Special Package Price		579.60
	SAVE		124.40

Special pricing, substitutions not allowed

USD MSRP (C)



Use the tabletop to lay out promotional products and swag, and the EuroFit walls to accent the display.

Suggested Uses:
Career Fairs
Vendor Events
Sales Meetings
Conventions

MICRO GEOMETRIX POP-UP

This package makes your presentation pop.

- The Micro GeoMetrix Classic kit features fabric graphic panels so you can create a custom look
- The double-sided EuroFit straight wall kit is a lightweight and stylish addition to this package



Table not included in package

Case



Square hard case with wheels

Item #390033 - Micro GeoMetrix Pop-Up Total Show Package

Total Show Package Includes:		Price	Price
337207	Micro GeoMetrix Classic Kit	410.00	256215
104022	6'/8' Convertible Throw (Full-Color Full-Bleed)	320.00	220011
	3'W x 90"H EuroFit Straight Wall Kit		332.00
	Square Hard Case with Wheels		365.00
	3 Setup Fees		FREE 60.00
	Regular Price		1487.00
	Special Package Price		1284.30
	SAVE		202.70

Special pricing, substitutions not allowed

USD MSRP (C)



8' draped throw can be converted down to a 6' fitted throw.

4 DAYS
AFTER FINAL PROOF APPROVAL
PRODUCTION LEAD TIME IS

Please note: Substitutions not allowed.
View current graphic templates, assembly videos and instructions on our website.
See pages 224-226 for additional information that may apply to your order.

Suggested Uses:

- Trade Shows
- Sale Kits
- Product Demos
- Recruiting Events



TRANSFORMER

Arrange your space in different ways for a unique feel at every event.

- Double-sided EuroFits are lightweight and stylish
- EuroFit Tagalong easily attaches to the side of the EuroFit Wall or on top to connect two EuroFit Walls together
- Impress Rectangle Counter Kit gives you hidden storage space

Endless Transformations



For smaller spaces



For larger spaces



TOTAL SHOW PACKAGES

Item #390048 - Transformer Total Show Package

Total Show Package Includes:		Price		Price	
256215	2 - 3'W x 90"H EuroFit Straight Wall Kits	644.00	256439	5'W EuroFit Tagalong Kit	179.00
256320	2 - 2'W EuroFit Incline Wall Kits	480.00	257047	Impress Rectangle Counter Kit	455.00
				6 Setup Fees	FREE 120.00
				Regular Price	1878.00
				Special Package Price	1582.20
				SAVE	295.80

Special pricing, substitutions not allowed

USD MSRP (C)

Suggested Uses:

- Trade Shows
- Presentations
- Store Promotions
- Product Launches

PRODUCT PROMOTER

With a merchandise display, podium and vibrant backdrop, this combo packs a brilliant presentation into an easily transportable wheeled case.

- The 10' EuroFit Straight Wall kit is the perfect backdrop for a stunning presentation
- Cascade Hanger Merchandiser includes a mount for a 23" monitor (not included) and a rack to hang up to 10 lbs. of apparel
- A Case-to-Counter Conversion kit transforms the hard case into a podium
- All of this breaks down and packs into the included Oval Hard Case with Wheels



Item #390187 - Product Promoter Total Show Package

Total Show Package Includes:		Price		Price	
256251	10'W x 90"H EuroFit Straight Wall Kit	1335.00	112008	UltraFit Case-to-Counter Conversion Kit	188.80
256390	EuroFit Hanger Merchandiser Kit	380.00	220017	Oval Hard Case with Wheels	420.00
				2 Setup Fees	FREE 40.00
				Regular Price	2363.80
				Special Package Price	2091.42
				SAVE	272.38

Special pricing, substitutions not allowed

USD MSRP (C)

Please note: Substitutions not allowed.
View current graphic templates, assembly videos and instructions on our website.
See pages 224-226 for additional information that may apply to your order.

AFTER FINAL PROOF APPROVAL
PRODUCTION LEAD TIME IS
4 DAYS

Suggested Uses:
Parties
Sporting Events
Carnivals
Trade Shows



PHOTO FUN INDOOR

This package gives you everything you need to create viral photo opportunities.

- A EuroFit Straight Wall kit makes a great photo backdrop
- FrameWorx Face Cutout Quad kit creates fun photo ops for up to four people at a time
- A Selfie Frame gives your guests the chance to become social media stars

Item #390026 - Photo Fun Indoor Total Show Package

Total Show Package Includes:		Price		Price	
263334	8.5' FrameWorx Face Cutout Quad Kit	390.00	271131	24" x 36" Selfie Frame	21.70
256251	10'W x 90"H EuroFit Straight Wall Kit	1335.00	400052	Jumbo Easel	96.00
				3 Setup Fees	FREE 60.00
Special pricing, substitutions not allowed				Regular Price	1902.70
				Special Package Price	1658.43
				SAVE	244.27

USD MSRP (C)

PHOTO FUN OUTDOOR

Perfect for outdoor events, this package provides both entertainment and photo ops.

- Value Bag Toss Game includes two game boards and eight bean bags
- The Face Cutout Wall attaches to your 10' tent and creates opportunities for fun photoshoots
- A Selfie Frame gives your guests the chance to become social media stars



Tent Kit Includes:



Item #390027 - Photo Fun Outdoor Total Show Package

Total Show Package Includes:		Price		Price	
240619	10' Standard Tent Kit (Full-Color Full-Bleed)	1213.00	271131	24" x 36" Selfie Frame	21.70
240369	Face Cutout Wall for 10' Tents	570.00	400052	Jumbo Easel	96.00
280130	Value Bag Toss Game Kit	161.00		4 Setup Fees	FREE 80.00
Special pricing, substitutions not allowed				Regular Price	2141.70
				Special Package Price	1855.53
				SAVE	286.17

USD MSRP (C)

INDOOR | OUTDOOR
4 or 7 DAYS
AFTER FINAL PROOF APPROVAL
PRODUCTION LEAD TIMES

Please note: Substitutions not allowed.
View current graphic templates, assembly videos and instructions on our website.
See pages 224-226 for additional information that may apply to your order.

TAILGATER

Show off your team spirit with this fantastic combination of tailgating products.

- Outdoor Fitted Table Throw works well in any environment
- Standard Tent kit provides shade at your event
- Outdoor Event Cooler holds up to 40 lbs. of ice to keep your beverages cold
- Premium Razor Sail Sign maximizes your advertising space
- Sail Sign mount works with your Standard Tent frame



Tent Kit Includes:



Soft Carry Case with Wheels



Stake Kit



Table not included in package

Item #390025 - Tailgater Total Show Package

Total Show Package Includes:		Price		Price	
240612	10' Standard Tent Kit (Full-Color Imprint, 2 Locations)	643.00	190672	13' Premium Razor Sail Sign Kit (Single-Sided with Ground Spike)	277.10
107060	6' Outdoor Fitted Table Throw	330.00	240521	Sail Sign Mount for Standard Tent Frame	34.40
280240	Outdoor Event Cooler Kit	405.00		4 Setup Fees	FREE 80.00
Special pricing, substitutions not allowed				Regular Price	1769.50
				Special Package Price	1520.55
				SAVE	248.95
					USD MSRP (C)

MARKET FEST

Make a splash at the next farmers market, fair or event with this easy-to-assemble tent package.

- Great for indoor or outdoor use
- Outdoor Fitted Table Throw works well in any environment
- Standard Tent kit provides shade at your event
- Tent wall defines your space by adding a clean backdrop
- Premium Teardrop Sail Sign maximizes your advertising space
- Sail Sign mount works with your Standard Tent frame



Tent Kit Includes:



Soft Carry Case with Wheels



Stake Kit



Table not included in package

Item #390177 - Market Fest Total Show Package

Total Show Package Includes:		Price		Price	
240612	10' Standard Tent Kit (Full-Color Imprint, 2 Locations)	643.00	190687	11.5' Premium Teardrop Sail Sign Kit (Single-Sided with Ground Spike)	277.10
240082	10' Tent Full Wall (Black or White, Unimprinted)	162.00	240521	Sail Sign Mount for Standard Tent Frame	34.40
107060	6' Outdoor Fitted Table Throw	330.00		3 Setup Fees	FREE 60.00
Special pricing, substitutions not allowed				Regular Price	1606.50
				Special Package Price	1301.85
				SAVE	204.65
					USD MSRP (C)

Please note: Substitutions not allowed.
View current graphic templates, assembly videos and instructions on our website.
See pages 224-226 for additional information that may apply to your order.

AFTER FINAL PROOF APPROVAL
PRODUCTION LEAD TIME IS
4 DAYS

GRAPHIC & PRINT GUIDELINES

PRODUCT TEMPLATES

Templates ensure artwork is printed correctly. Always use the most recent templates, which can be found in the "Graphic Templates" tab on each product page of our website.

- Do not leave template lines in artwork
- Templates are available for custom products/orders upon request

Save TIME, MONEY and HASSLE with templates specifically created for each product.



Each template includes file setup specs for sizing your artwork, including the bleed, finished and safe areas.

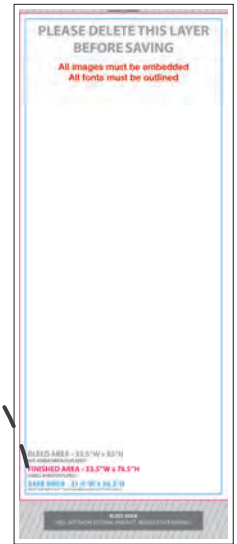

PRINT METHOD	ACCEPTABLE FILES	FILE FORMAT	PRINTING SPECIFICATIONS
Full-Color Imprint	Vector with fonts outlined	Adobe Illustrator .ai .eps .pdf	<ul style="list-style-type: none"> - All files are printed in CMYK (process color); PMS (spot) colors and RGB files will be converted to CMYK prior to printing - Halftones/percentages of PMS colors and contained gradients are acceptable - Minimum line thickness 0.125" (8-9 pt. stroke) - Minimum of 0.25" width and height on all individual elements - Minimum of 0.5" x 0.5" for all registered trademarks, trademarks, copyright symbols, etc.
Full-Color Inkjet & Full-Color Dye Sublimation	Vector with fonts outlined and links embedded Raster	Adobe Illustrator .ai .eps .pdf Adobe Photoshop (High Resolution) .tif .psd .eps .pdf .jpg	<ul style="list-style-type: none"> - Use product template to set up print-ready artwork - All files are printed in CMYK (process color); PMS (spot) colors and RGB files will be converted to CMYK prior to printing - Full-color artwork including gradients, raster/photo images and bleeds - Raster images must be created at actual size with 200 dpi resolution - Minimum of 24 pt. reversed-out text - Minimum of 12 pt. regular text - Minimum line thickness: 1 pt. regular text, 2 pt. reversed-out text

VECTOR ART

(Recommended for all products)

- Can be scaled to any size while maintaining quality
- Known as line art
- Vector artwork is preferred (unless printing photos)



.eps, .ai, .pdf

RASTER ART

- Known as bitmap art
- Composed of pixels (or tiny squares) grouped together to make one complete image
- When scaled larger, the image will look pixelated (or jagged)
- Submit art at 200 DPI (dots per inch)



.tif, .psd, .eps, .pdf, .jpg

OUTLINED FONTS

(Required for all products)

Font selection can vary from computer to computer, which can cause a desired font to be replaced with a generic one. To preserve your fonts, always outline, embed, or convert them to curves before submitting artwork.



Original font



Missing font replaced with a generic one



Original font when outlined, embedded or converted to curves

EMBEDDED IMAGES

(Required for all products)

Most programs allow the user to add an image to a file by linking or embedding. Embedded images are stored within the document itself, while linked files are not. Because of this, linked files can suddenly vanish when opened from a different computer. Embed all images to avoid losing them when files are submitted.



200 DPI

High resolution images include:
Unedited, original raw digital photos and stock photos

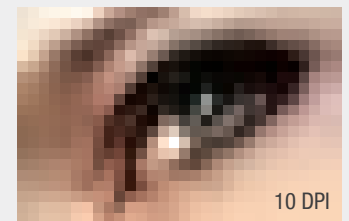

10 DPI

Low resolution images are:
Photos taken from the internet, scanned images, photos taken on a cell phone, screenshots, etc.

UNACCEPTABLE FILE FORMATS:

Quark, Corel Draw, Word, PowerPoint, Excel, Publisher, Pagemaker, low-resolution scanned images. (InDesign files, unless exported to .eps or .pdf format, will incur additional charges or be rejected.)

GRAPHIC & PRINT GUIDELINES

FILE PREPARATION

PRODUCT TEMPLATES - showdowndisplays.com

Graphic templates can be found in the "Graphic Templates" tab on each product page of our website. Graphic dimensions are subject to change without notice.

REQUIREMENTS

Documents must be print ready and submitted at 100% final size, with no additional manipulation necessary; additional charges may apply if these terms are not met. Before submitting artwork, convert all text to outlines, paths or curves to ensure exact duplication of type style. Alterations to submitted artwork will result in a necessary proof approval, which may delay production time. We reserve the right to delay or reject any order based on the quality of the artwork received.

We also reserve the right to make slight alterations to your file to adapt to our printing process. Some thin lines or small shapes may not reproduce at the size or thickness submitted. Multicolor close-registration prints are not available on all products.

Please see page 224 for specific information relating to each print method.

ARTWORK SUBMISSION & PROOFING

UPLOADING ARTWORK

For the fastest and most efficient artwork processing, please submit art via our website:

<https://www.showdowndisplays.com/artwork>

You must have an account and be logged in. Our factory will not be held responsible for any server malfunction that affects the receipt of your files.

ELECTRONIC PROOFS

Proofs are provided electronically in PDF format. These depict a low-resolution representation of the final product and should not be used for final color output or image resolution. Additional proofs may incur a proof revision charge of \$10.00(G) each, plus additional design time. Proof approvals must be submitted via our online proofing system before production will begin.

All proof approvals received after 12:00 PM Central will be counted as received on the next business day. Production time begins after the final proof approval is received.

GRAPHIC DETAILS

ERRORS

We will not be held responsible for errors resulting from copy that was received or approved incorrectly.

TYPESETTING

Our normal art setup fee includes up to three lines of copy. If a specific font is required, the name of that font must be noted on your purchase order. If we do not have the desired font, the type will be re-set using a standard font or one that matches the desired font as closely as possible.

CHANGE OF COPY CHARGE

Whether for a new or repeat order, any request for an addition, deletion or change to the copy in a vector artwork file will result in an **\$10.00(G) Change of Copy Charge**.

REPEAT ORDERS

There are no setup fees for exact repeat orders placed within two years of original order. Any artwork older than two years must be resubmitted. Proof approvals are required on all repeat orders.

*****ARTWORK THAT HAS BEEN ALTERED IN ANY WAY CANNOT BE CONSIDERED FOR A REPEAT ORDER*****

COLOR

COLOR POLICY

All of our products are printed CMYK (process color). If your artwork requires a specific color, please request a test grid (see below).

WE CANNOT GUARANTEE COLOR MATCHING.

TEST GRID*

If you are concerned about a specific color, we suggest ordering a test grid. Test grids are printed samples of your requested PMS (spot) color and its surrounding color family (e.g. reds, blues, etc.). These test grids contain the CMYK (process color) equivalent of PMS colors. The vast majority of PMS colors cannot be accurately represented in a CMYK printing process. Please state on your purchase order that you are requesting a test grid and the specific PMS color(s) you are trying to achieve.

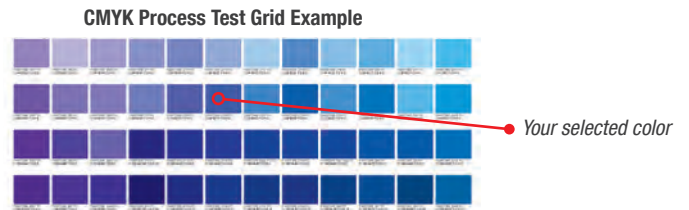

MATCH PRINT*

A match print is a 1/4 scale print of an entire art file. This is the most accurate way to represent an entire printed piece, since it will mimic the color and appearance of the piece as a whole, excluding any finishing. Please state on your purchase order that you are requesting a match print so it will be recorded on your order.

TEST STRIPS*

For the most detailed representation of full-size print quality and image resolution, we recommend requesting a test strip. An 8" x 20" section of the art is printed at 100%. Please state on your purchase order that you are requesting a test strip so it will be recorded on your order.

**The first test grid, match print and test strip available at no charge (customer to pay freight). Each additional test grid, match print or test strip is \$20.00(G) plus freight, expedited charges apply.*



COLOR ACCURACY

Our customers deserve the best quality prints and most consistent, accurate color possible. As a G7 Master Qualified printer, we provide industry-leading color accuracy throughout our printing and production processes.

GENERAL INFORMATION

HOW TO ORDER

WEB ORDERS – SHOWDOWNDISPLAYS.COM

Orders placed via our website will receive a 2% discount, and setup fees will be waived. Submit art at time of order placement for faster order processing.

EMAIL ORDERS – ORDERS@SIGNZONEINC.COM

Orders may be emailed.

PHONE ORDERS – 888-376-7469

Our Customer Care team is dedicated to helping you place an order. Please give us a call during our customer service hours: 7:00 a.m. to 5:30 p.m. Central, Monday through Friday

FAX ORDERS – 763-746-1133

Faxed orders are accepted as original orders. Any written confirmation of a faxed order must be marked "CONFIRMATION OF FAX – DO NOT DUPLICATE" to avoid duplicate orders.

HARDWARE-ONLY ORDERS

Most hardware-only orders placed before 2:00 p.m. Central will ship the same day (subject to capacity and inventory levels). Customer Care will inform you of any shipment delays at the time of ordering.

IMPRINTED PRODUCTS

Refer to the product's production lead time. See the DEFINITIONS section for details.

ALL ORDERS/APPROVALS RECEIVED AFTER NOON CENTRAL WILL BE PROCESSED ON THE NEXT BUSINESS DAY. OUR FACTORY IS NOT RESPONSIBLE FOR ANY OMITTED INFORMATION OR SERVER/FAX MALFUNCTIONS THAT AFFECT RECEIPT OF THE ORDER.

ORDERING DETAILS

CREDIT/PAYMENT TERMS

All orders must be prepaid until credit terms are established. We accept Visa, MasterCard and American Express credit cards. All new customers are required to prepay their first order. Credit application is available on our website: showdowndisplays.com

ORDER CHANGES & CANCELLATIONS

No graphic or product manufacturing changes will be accepted after final proof approval. Customer is responsible for all labor and material costs incurred prior to cancellation and will be billed accordingly.

SHIPPING

MULTIPLE DROP-SHIP ADDRESSES OR SPLIT SHIPMENTS

A \$5.00(G) fee will be added for each additional address, plus all applicable shipping and handling. Contact Customer Care for the formal drop-ship address document to complete. Additional fees may apply depending on the request.

SHIPPING

Visit our website for shipping information and packing dimensions. Printed products ship F.O.B. Ramsey, MN 55303 or Huntsville, AL 35811 see website for details. Special shipping and pricing guidelines apply to oversized products to ensure product is delivered intact and on time.

RETURN POLICY

CLAIMS/RETURNS

Any damages or discrepancies must be reported within five days of receipt of merchandise. We reserve the right to not honor any claims not reported within five days. Returns will not be accepted after 90 days and cannot be returned without prior authorization from our factory. Returns may be subject to a 15% restocking fee. Contact Customer Care for additional processing information about claims or returns.

SUBSTITUTIONS

Due to unavoidable style modifications and enhancements to the products within this catalog, we may need to substitute a product with a similar item of comparable cost and style. We reserve the right to withdraw any product offering without prior notification.

DEFINITIONS

SETUP FEE - \$20.00(G)

The setup fee represents all costs of preparing print process-ready artwork for production, as well as email proofing and two years of archival storage. There is no setup fee when referencing a previous order within two years of order placement, for the same item using exact previous artwork. This setup fee will not be applied to orders placed via our website.

PRODUCTION LEAD TIMES

A production lead time is the amount of time it takes our factory to produce a finished product once final proof approval is received. Production lead times are listed for each product on their respective catalog pages and are subject to capacity and inventory levels. Your order will be scheduled within our production lead times or with rush service as requested to meet a required in-hands date. The factory reserves the right to adjust lead times. Customers will be contacted regarding affected orders.

Production begins upon receipt of:

- Complete purchase order
- Payment/credit approval
- Production-ready artwork
- Final proof approval

Your order will ship on or before the scheduled ship date via the freight method requested on the purchase order.

PROP 65 APPROVED

All of the products in this catalog have been tested and have passed Proposition 65 standards. Every one of these products can be sold in the state of California without a Prop 65 warning label.

QUICK SHIP 24-HOUR OR 48-HOUR QUICK SHIP

Completed purchase order, payment and production-ready artwork must be received by 5:00 p.m. Central. Orders must be placed via our website. Established credit terms or credit card payment will be due at the time of order placement. Quick Ship item numbers must be used when placing orders for this program. Order drop ships from our factory on the next business day (24-Hour Quick Ship) or within two business days (48-Hour Quick Ship) via UPS or FedEx only.

- Proofs are not available; accuracy of the artwork is the customer's responsibility
- Our factory will not be held responsible for any delays in the shipment due to discrepancies with the artwork and/or purchase order
- Virtual samples and design services are not available
- Quick Ship items cannot be combined with items that have regular lead times on any purchase order
- Artwork setup fee is included in the price
- Maximum quantity per order per day, indicated by end-column quantity
- This program is subject to availability

RUSH CHARGES/FEES

For products not included in our Quick Ship program, rush service is available; this requires a prior approval by Customer Care. All documents received after 12:00 p.m. Central will be counted as received on the next business day. Same-day service is not available.

Standard rush charges:

Subtract one business day from product lead time = \$75.00(G)

Subtract two business days from product lead time = \$125.00(G)

WARRANTY

All of our products are designed to be cost effective and durable. Unless otherwise stated on the product's catalog page, standard hardware warranty is a one-year parts and labor warranty, which warrants product against defects in material or workmanship. Warranties do not cover damage due to accidents, abuse, or normal wear and tear. Products found to be defective will be replaced or repaired at the discretion of our factory.

TRADEMARKS

By submitting artwork to our factory, the customer assumes full responsibility for its use. Our factory will not be held responsible for submitted artwork that violates applicable laws or restrictions.

CREATIVE SERVICES

FREE VIRTUAL SAMPLE SERVICES

Having a hard time visualizing your completed art or logo on our products?
Try a virtual sample.

SERVICE DETAILS:

- We will apply a logo or completed artwork to a product image
- Requests are processed within 1-2 business days
- Free service is limited to three virtual samples maximum

RESTRICTIONS:

- Design and layout are not included
- Virtual samples are not available for Quick Ship products or in-house orders
- Virtual samples depict a rough representation of the product and should not be used for proofing

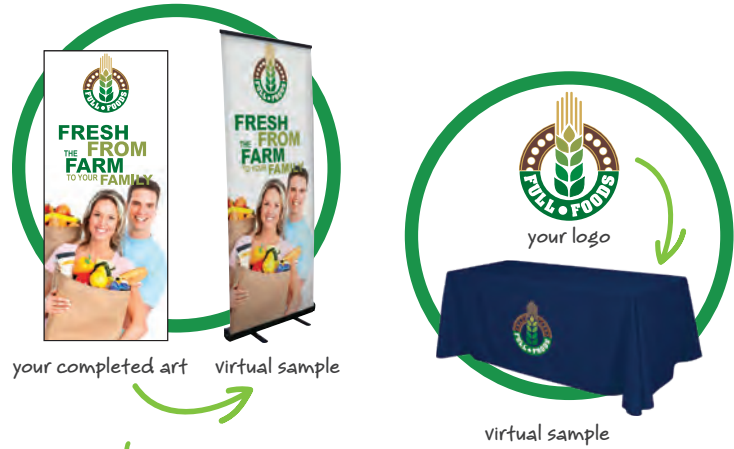

over 60% of virtual samples become orders

Contact us at: creativeservices@signzoneinc.com

DESIGNERS FOR HIRE - YOUR VERY OWN ART DEPARTMENT

For an additional fee, you can connect with designers who specialize in creating artwork for our product line.

SERVICE DETAILS:

- Design and layout
- Creation of production-ready art
- Logo re-creation

HOW TO GET STARTED:

- Email us your project details and contact information
- You will receive your quote within 24 hours (one business day) of your request
- Creation of art will begin upon receipt of:
 - Approved design time quote
 - Purchase order including design time
 - Payment/credit approval
- Projects extending beyond quoted design time due to customer revisions will require the purchase of additional design time (you will be contacted by Creative Services to make the change to your order)

RESTRICTIONS:

- Design services are not available for Quick Ship products
- Additional lead time is required for this service
- Design services are only available for our product line

Contact us at: creativeservices@signzoneinc.com

Go From Ordinary... to Wow!



Go From Unusable... to Production-Ready!



Creative Design Services Pricing

Item #	Description	Price
290006	30 Minutes of Design Time	60.00
		USD MSRP (G)



Our corporate philosophy is to provide opportunity and security for all our employees. In recent years, we've extended this philosophy beyond our walls through our partnership with Common Hope.

Through Common Hope, our employees now sponsor more than 90 children in Guatemala. We help these children acquire high-school-level education in a country where the average adult has received only 5.4 years of schooling. We've had several volunteer teams travel to Guatemala, where they've helped build homes and organize classroom activities.

PLEASE VISIT WWW.COMMONHOPE.ORG AND JOIN US IN HELPING THE CHILDREN OF GUATAMALA.









WE'RE BEYOND COMPLIANT. WE'RE APPROVED!

One of the pillars of our On Target Guarantee is a Commitment to Product Safety and Quality. All our products are not just Prop 65 compliant – they're actually approved. This means that all of the products have been tested and have passed Proposition 65 standards. Every one of these products can be sold in the state of California without a Prop 65 warning label.

On Target GUARANTEE

-  On-Time Delivery or That Product Is Free
-  100% Satisfaction Guaranteed
-  Your Call Answered in 60 Seconds or Less
-  Our Commitment to Safety and Quality
-  Marketing Support to Build Your Business

*Please visit our website for details at showdowndisplays.com

Distributed by:

Valid through December 31, 2020



asi 87188



PPAI 254687



SAGE 67383



UPIC SHOWDOWN



PPPC 20101202

295634